

Minibar Systems

Minibar

Case Good Specifications

Index

1.	Ventilation – Basic Principles and the Minibar Environment	3
1.1.	Inlet Ventilation	3
1.2.	Shelf Cutout	4
1.3.	Exhaust Ventilation	4
2.	General Notes	4
2.1.	Securing the Minibar	4
2.2.	Door Opening	4
2.3.	Power Socket Isolation and Location	4
2.4.	Case Good Door Hinges	5
2.5.	Case Good Construction and Rigidity	5
3.	Minibar Models	6
4.	Diagram A – Cavity Opening	7
5.	Sample Installations	8
6.	Minibar Systems Contact Information	10

The Minibar Case Good Specifications details the criteria necessary for installation. Minibar Systems is pleased to provide a complimentary service for hotels and their designers where we meet the you to discuss details such as: aesthetics, minibar location to maximize profits, door swing space, proximity to power, and ventilation requirements. These details are essential for the efficient running of the refrigeration systems ensuring its long life span and trouble free operation.

1. Ventilation – Basic Principles and the Minibar Environment

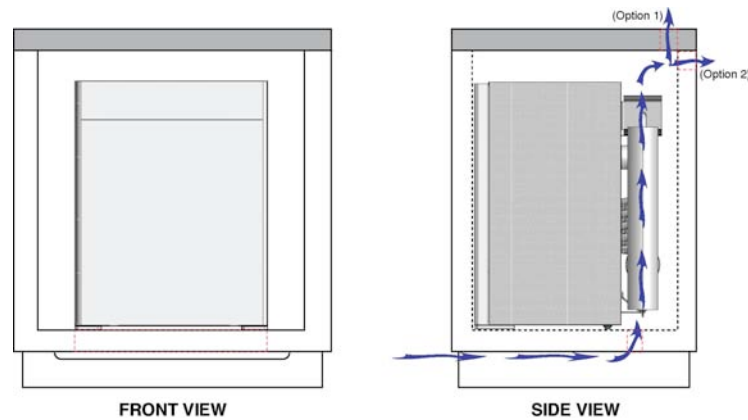

Ventilation occurs by convection. Convection is the transfer of heat by air currents. A cut out is required under the bar shelf for air circulation. It allows air to rise up over the cooling unit and exhaust out of the cabinet allowing for proper ventilation and performance of the minibar.

Minibar Systems would like to stress that proper ventilation for the minibar is imperative to ensure maximum efficient operation of the cooling unit. The minibar must not be placed against a heating radiator, window, direct sunlight or curtains. Ventilation grills or slots must not be covered.

1.1 Inlet Ventilation

The inlet vent(s) must have a minimum of 31 in² (200 cm²) to comply with specifications. This is based on a typical guest room environment of 73° F (23° C) with a relative humidity of no more than 80%. The vent can be provided in any of the following configurations:

- i) A cutout in the toe kick
- ii) A series of slots in the toe kick
- iii) A grill in the toe kick
- iv) An arched opening in the toe kick



1.2 Shelf Cutout

The shelf is to be cut away directly below the cooling unit. Please refer to Diagram A for this measurement depending on your minibar model. This must be a minimum open area of 31 in² (200 cm²). This is important for maximum cooling efficiency. The easiest way to accomplish the required ventilation is to cut away the shelf across its complete width and extend the cut out back to the rear of the case good.

1.3 Exhaust Ventilation

The exhaust vent(s) must have a minimum of 31 in² (200 cm²) to comply with specifications. The vent can be provided in any of the following configurations:

- i) A series of slots in the top (see previous diagram Option 1)
- ii) A grill in the top (see previous diagram Option 1)
- iii) If the design will not permit the use of slots or grills, the unit can be spaced 2" (50.8 mm) from the wall to allow exhaust. It is recommended that spacers be used to prevent the case good from being pushed against the wall. The underside of the shelf above the minibar must be flat so no obstruction is caused to the airflow. In this instance the back of the unit housing the minibar must be cut away completely (see previous diagram Option 2).

The exhaust vent must exit into free space in the guest room. *It must not vent into an enclosed space such as a closet, case good or ceiling void, as the heat will be trapped. The minibar must not be placed against a heating radiator, window, direct sunlight or curtains. Ventilation grills or slots must not be covered.*

2. General Notes

2.1 Securing the Minibar

Secure the minibar feet to the case good when applicable.

2.2 Door Opening

The minibar requires sufficient space within the guest room to open to a minimum angle of 90°. This is for guest convenience, attendant refilling and future maintenance needs.

2.3 Power Socket Isolation and Location

All mains power outlet sockets should be located within close proximity of the minibar.

A standard AC mains outlet socket with safety ground is provided. The AC mains supply to minibar must be clean and stable.

2.4 Case Good Door Hinges

Minibar Systems recommends the designer and case good manufacturer utilize strong hinges designed to carry the weight of a guest leaning on the door.

2.5 Case Good Construction and Rigidity

All case good construction must be square or “plumb” and of solid material. This will ensure reliable and trouble free operation of the minibar. The case good bottom must be level* and able to support the weight of a fully stocked minibar that weighs approximately 90 lbs. (40.8 kg).









The maximum tolerance is 3/32” (2.6 mm) over a 1’ (300 mm) level or 3/16” (5.2 mm) over a 2’ (600 mm) level. This equates to a ½ degree angle.

**The support shelf must be level on both the X- and Y-axis (i.e., side to side and front to back).*



3. Minibar Models

The physical cavity opening must be larger than the minibar to allow a minimum of 0.5" (12.7 mm) at both sides and top. This will allow the minibar to be removed as needed. See Diagram A for cavity dimensions.

	MINIBAR	Height	Width	Depth
	MC 30 Primo 30	20.5" 520.7 mm	15.88" 403.35 mm	16.73" 425 mm
	Compact 40 MC 40 Primo 40	20.5" 520.7 mm	15.88" 403.35 mm	18.7" 475 mm
	Fridge 50	20" 508 mm	18.9" 480.06 mm	20.1" 510.54 mm
	SmartFridge 50 SuperFridge 50	20.5" 520.7 mm	18.9" 480.06 mm	20.1" 510.54 mm
	SmartFridge 65 SuperFridge 65	26.8" 680.72 mm	18.9" 480.06 mm	20.1" 510.54 mm
	Primo+ 20	17.72" 450 mm	14.17" 360 mm	17.32" 440 mm
	with Aluminum Door	17.72" 450 mm	14.17" 360 mm	16.73" 425 mm
	Primo+ 30	20.47" 520 mm	15.75" 400 mm	17.32" 440 mm
	with Aluminum Door	20.47" 520 mm	15.75" 400 mm	16.73" 425 mm
	Primo+ 40	20.47" 520 mm	15.75" 400 mm	19.29" 490 mm
	with Aluminum Door	20.47" 520 mm	15.75" 400 mm	18.7" 475 mm

4. Diagram A – Cavity Opening

Minibar	A*‡ (Shelf Cutout)	B*‡ (Depth)	C (Width)	D (Height)
MC 30 Primo 30	13.25" 336.55 mm	17.48" 444.05 mm	16.88" 428.75 mm	21.0" 533.4 mm
Compact 40 MC 40 Primo 40	15" 380 mm	19.45" 495.03 mm	16.88" 428.75 mm	21.0" 533.4 mm
Fridge 50	16.6" 521.72 mm	20.85" 529.59 mm	19.9" 505.46 mm	20.5" 520.7 mm
SmartFridge 50 SuperFridge 50	16.6" 421.64 mm	20.85" 529.59 mm	19.9" 505.46 mm	21.0" 533.4 mm
SmartFridge 65 SuperFridge 65	16.6" 421.64 mm	20.85" 529.59 mm	19.9" 505.46 mm	27.34" 694.44 mm
Primo+ 20	13.82" 351.03 mm	18.07" 459.05 mm	15.17" 385.4 mm	18.22" 162.7 mm
Primo+ 30	13.82" 351.03 mm	18.07" 459.05 mm	16.75" 425.4 mm	20.97" 532.7 mm
Primo+ 40	15.79" 401.07 mm	20.04" 509.05 mm	16.75" 425.4 mm	20.97" 532.7 mm

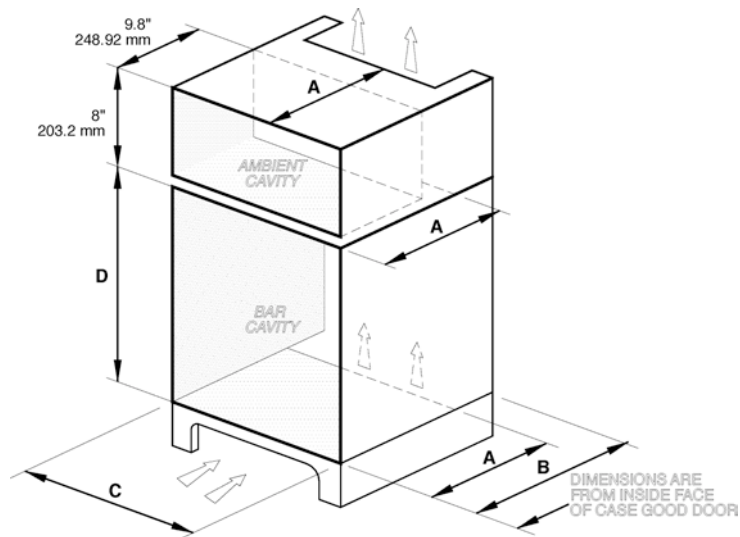

Notes

- Dimensions are in inches and millimeters
- All dimensions are internal
- All tolerances 0.12" (3 mm)
- 8" (203.2 mm) recommended for height of ambient housing section for snacks
- * Compressor units require 0.75" (19 mm) in additional depth
- ‡ If the key is stored inserted into the minibar lock, allow an additional 1.2" (30 mm)
- Not to scale

5. Sample Installations



SmartCube SC-40i and optional electronic lock installed in snack compartment



SmartCube SC-40i and 12 sensor tiered SmartTray



Wood 12 sensor tiered SmartTray on a pull out shelf



Ambient snack trays in a pull out drawer

Minibar
Case Good Specifications



SmartCube SC-40i and safe



SmartCube SC-40i, SmartFridge, and external snack basket



SmartCube SC-40s with optional full glass door, black wood 12 sensor SmartTray, and 1x6 snack tray in snack section (see photo inset)



SmartCube SC-60i, optional electronic lock on drawer, and two SmartTray single sensors

6. Minibar Systems Contact Information

Contact Customer Support if you would like: general information, pricing, spare parts, order status or to return items for repair/replacement.

United States

Customer Support

Hours of operation: Monday through Friday, 8:30 AM – 5:30 PM EST

Telephone: 301-309-1112

Fax: 301-309-9699

Email: customerservice@minibarNA.com

Technical Support

Hours of operation: Monday through Friday, 8:30 AM – 5:30 PM EST

Telephone: 301-309-1111

Fax: 301-309-9699

Email: tech5300@minibarNA.com

United Kingdom

Customer or Technical Support

Hours of operation: Monday through Friday, 09:00 AM – 17:00 PM

Telephone: +44 (0) 1628 820 800

Fax: +44 (0) 8700 519 708

E-mail: support@minibaruk.co.uk

Switzerland

Customer or Technical Support

Hours of operation: Monday through Friday, 08:00 AM – 17:00 PM

Telephone: +41 41 767 23 41

Fax: +41 41 767 23 23

E-mail: support@minibar.ch

France

Customer or Technical Support

Hours of operation: Monday through Friday, 09:00 AM – 17:00 PM

Telephone: +33 1 55 47 07 07

Fax: +33 1 47 49 61 62

E-mail: minibar.france@minibar.ch