

HEAVY DUTY 707

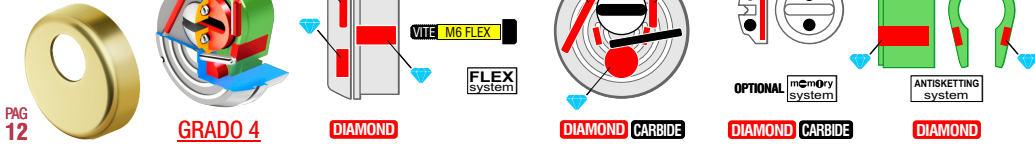

DIAMOND

ROK SFERIK
PAT. PEND.



PAG 12

MONOLITO KRIPTON

ROK SFERIK
PAT. PEND.

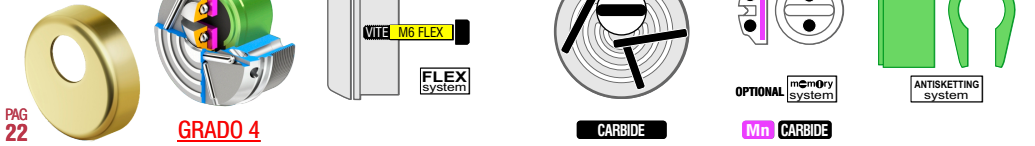

PAG 22

MONOLITO

ROK SFERIK
PAT. PEND.

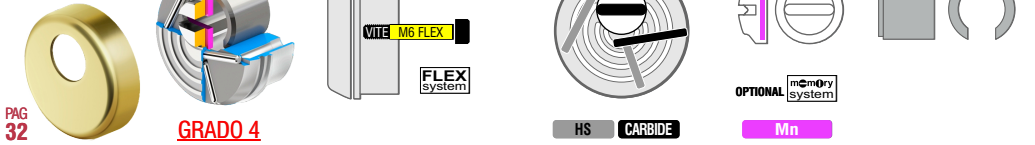

PAG 32

RwS

ROK SFERIK
PAT. PEND.

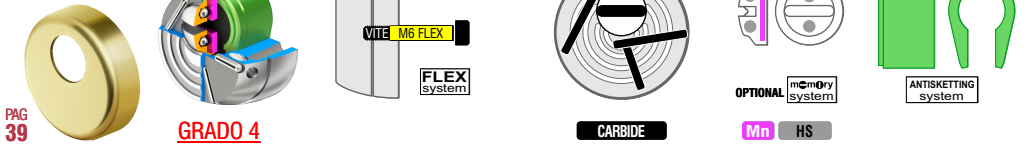

PAG 39

STONE

ROK SFERIK
PAT. PEND.

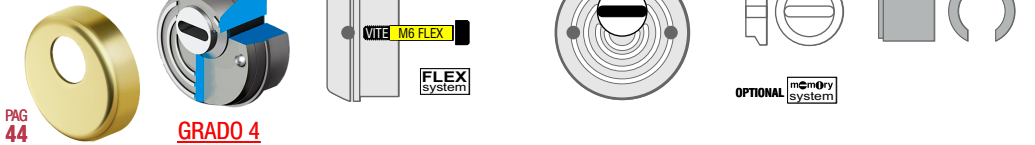

PAG 44

BDS

ROK SFERIK
PAT. PEND.

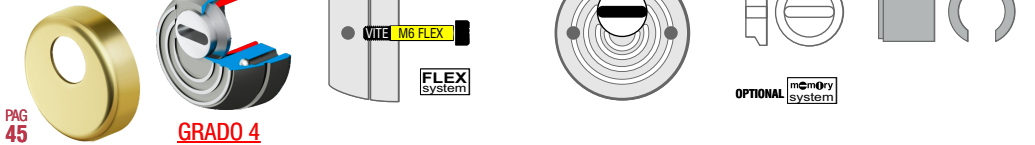

PAG 45

RB

ROK SFERIK
PAT. PEND.

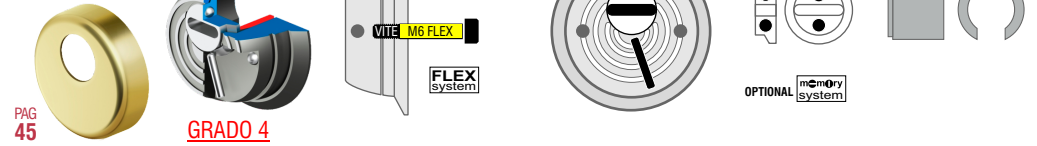

PAG 45

MAGNETIC LOCK PROTECTIONS

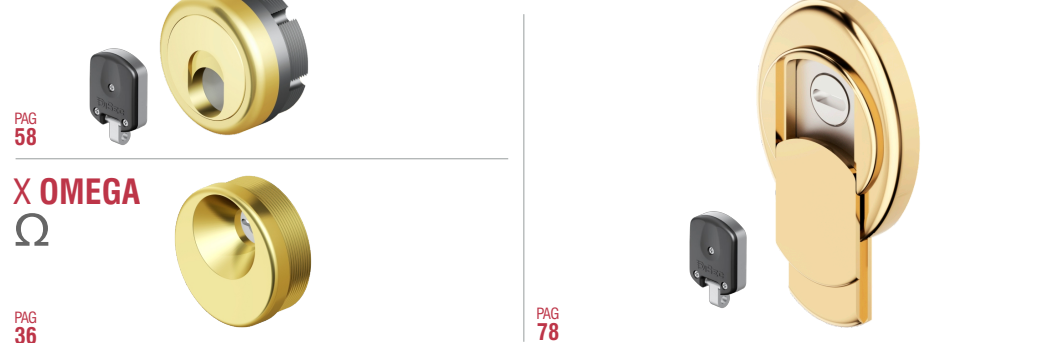

PAG 58

X OMEGA

Ω



PAG 36

ELECTRONIC CYLINDER LOCK PROTECTION



PAG 84

CONTRO DEF

ACCESSORIES



PAG 124

PAG 104

PAG 130



ROK SFERIK

PAT. PEND.



GRADO 4

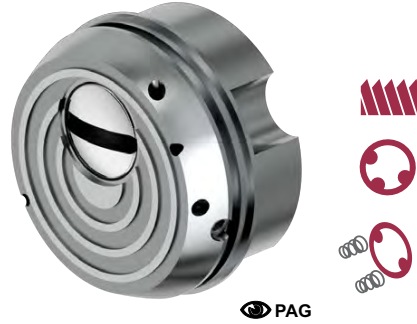

PAG



PAG



VIDEO

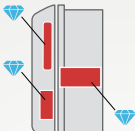

DIAMOND



DIAMOND CARBIDE



OPTIONAL memory system

DIAMOND CARBIDE



ANTISKETTING system

DIAMOND

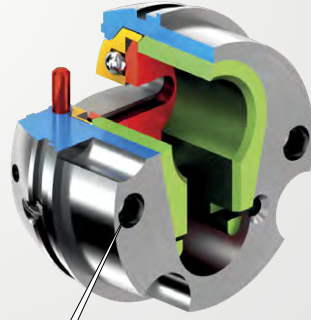

FLEX system

OPTIONAL MEMORY SYSTEM

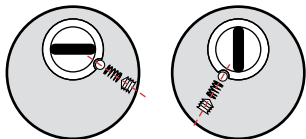

FLEX SYSTEM



5 VOLTE PIU' RESISTENTE DELLE VITI TRADIZIONALI 12.9

SUPER TOP 86x66



TOP 88x68



MONOLITO 88x68



MILANO Ø 65



MONOLITO E Ø 65



QUADRA 65x65



QUADRY 84x64





FILETTATO
Ø50
SFERIK

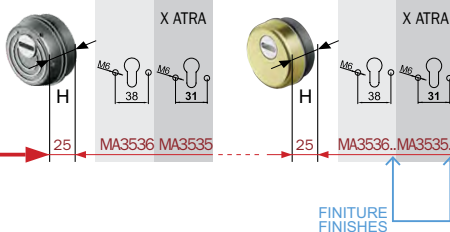

- A1561..**
- 0 Cromo lucido Bright Chrome
 - 1 Cromo satinato Satin Chrome
 - 2 Bronzo Bronze
 - 3 PVD Ottone PVD Brass
 - 4 Ottone satinato Satin Brass
 - 5 Bronzo satinato Satin Bronze
 - 6 Inox satinato Stainless steel

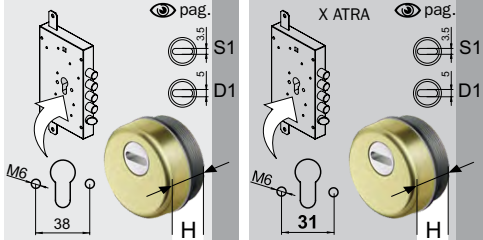

- FINITURE FINISHES**
- C Cromo lucido Bright Chrome
 - T Cromo satinato Satin Chrome
 - B Bronzo Bronze
 - 2 PVD Ottone PVD Brass
 - 4 Ottone satinato Satin Brass
 - 5 Bronzo satinato Satin Bronze
 - 6 Inox satinato Stainless steel

- SUPER TOP** 56x66
KT2896 h7
KT2897 h11
- TOP** 88x68
KT2002 h5
KT2001 h9
- MONOLITO** 88x68
A2082 h5
A1559 h11
- MILANO** Ø 65
A1612 h5
A1936 h11
- MONOLITO E** Ø 65
A2199
- QUADRA** 65x65
A3171 h5
A3060 h11
- QUADRY** 84x64
KT3481 h5
KT3482 h11

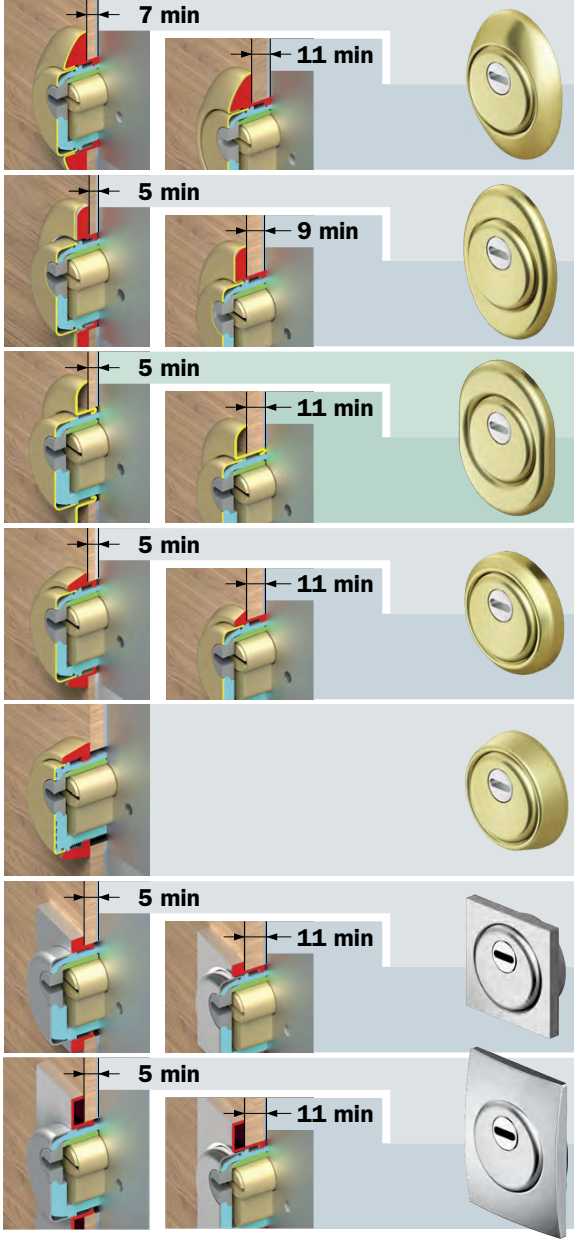

BKD291	25	..	BKD391	25	..	BKD291 8 25..
BKD290	25	..	BKD390	25
BKD271	25	..	BKD371	25
BKD270	25	..	BKD370	25
BKD251	25	..	BKD351	25
BKD250	25	..	BKD350	25
BKD261	25	..	BKD361	25
BKD260	25	..	BKD360	25
BKD28A	25	..	BKD38A	25
BKD251Q	25	..	BKD351Q	25
BKD250Q	25	..	BKD350Q	25
BKD251W	25	..	BKD351W	25
BKD250W	25	..	BKD350W	25

ESEMPIO DI CODICE PER VITI M8

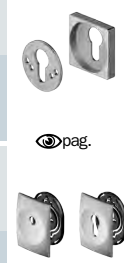

- FINITURE FINISHES**
- C Cromo lucido Bright Chrome
 - T Cromo satinato Satin Chrome
 - B Bronzo Bronze
 - 2 PVD Ottone PVD Brass
 - 4 Ottone satinato Satin Brass
 - 5 Bronzo satinato Satin Bronze
 - 6 Inox satinato Stainless steel



PAT. PEND.

Ø50

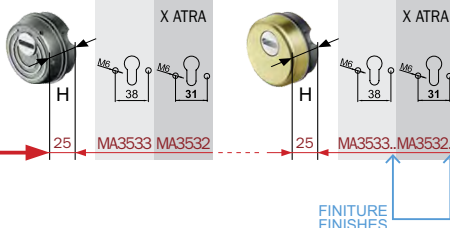

- A1561..**
- C Cromo lucido Bright Chrome
 - T Cromo satinato Satin Chrome
 - B Bronzo Bronze
 - 2 PVD Otone PVD Brass
 - TT Otone satinato Satin Brass
 - BS Bronzo satinato Satin Bronze
 - IT Inox satinato Stainless steel

FINITURE FINISHES

SUPER TOP 56x66			KT2896TK h7 KT2897TK h11
TOP 88x68			KT2002TK h5 KT2001TK h9
MONOLITO 88x68			A2815 h5 A2816 h11
MILANO Ø 65			A1612TK h5 A1936TK h11
MONOLITO E Ø 65			A2199TK
QUADRA 65x65			A3171TK h5 A3060TK h11
QUADRY 84x64			KT3481TK h5 KT3482TK h11

	7 min		11 min	
	5 min		9 min	
	5 min		11 min	
	5 min		11 min	
	5 min		11 min	
	5 min		11 min	
	5 min		11 min	

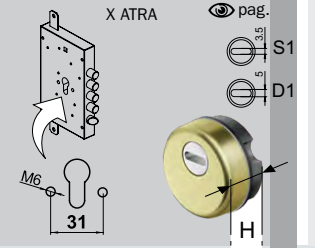
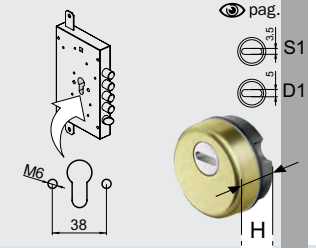

BKT291D	25	..	BKT391D	25
BKT290D	25	..	BKT390D	25
BKT271D	25	..	BKT371D	25
BKT270D	25	..	BKT370D	25
BKT201D	25	..	BKT301D	25
BKT200D	25	..	BKT300D	25
BKT211D	25	..	BKT311D	25
BKT210D	25	..	BKT310D	25
BKT28AD	25	..	BKT38AD	25
BKT251QD	25	..	BKT351QD	25
BKT250QD	25	..	BKT350QD	25
BKT251WD	25	..	BKT351WD	25
BKT250WD	25	..	BKT350WD	25



- FINITURE FINISHES**
- C Cromo lucido Bright Chrome
 - T Cromo satinato Satin Chrome
 - B Bronzo Bronze
 - 2 PVD Otone PVD Brass
 - BS Bronzo satinato Satin Bronze
 - IT Inox satinato Stainless steel
- pag.**
- C Cromo lucido Bright Chrome
 - T Cromo satinato Satin Chrome
 - B Bronzo Bronze
 - 2 PVD Otone PVD Brass
 - BS Bronzo satinato Satin Bronze
 - IT Inox satinato Stainless steel

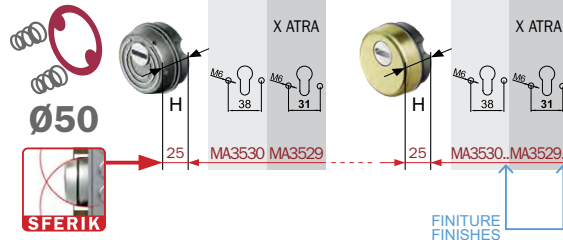

- A1561..**
- C Cromo lucido / Bright Chrome
 - T Cromo satinato / Satin Chrome
 - B Bronzo / Bronze
 - 2 PVD Ottonone / PVD Brass
 - TT Ottonone satinato / Satin Brass
 - BS Bronzo satinato / Satin Bronze
 - IT Inox satinato / Stainless steel

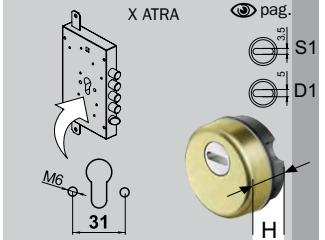
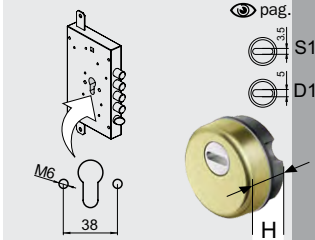

- FINITURE FINISHES**
- C Cromo lucido / Bright Chrome
 - T Cromo satinato / Satin Chrome
 - B Bronzo / Bronze
 - 2 PVD Ottonone / PVD Brass
 - TT Ottonone satinato / Satin Brass
 - BS Bronzo satinato / Satin Bronze
 - IT Inox satinato / Stainless steel

SUPER TOP 56x66			KT2896TK h7 KT2897TK h11
TOP 88x68			KT2002TK h5 KT2001TK h9
MONOLITO 88x68			A2815 h5 A2816 h11
MILANO Ø 65			A1612TK h5 A1936TK h11
MONOLITO E Ø 65			A2199TK
QUADRA 65x65			A3171TK h5 A3060TK h11
QUADRY 84x64			KT3481TK h5 KT3482TK h11

	7 min				NNNN
	11 min				NNNN
	5 min				NNNN
	9 min				NNNN
	5 min				NNNN
	11 min				NNNN
	5 min				NNNN
	11 min				NNNN
	5 min				NNNN
	11 min				NNNN

BKF291D	25	..	NNNN	BKF391D	25
BKF290D	25	..	NNNN	BKF390D	25
BKF271D	25	..	NNNN	BKF371D	25
BKF270D	25	..	NNNN	BKF370D	25
BKF201D	25	..	NNNN	BKF301D	25
BKF200D	25	..	NNNN	BKF300D	25
BKF211D	25	..	NNNN	BKF311D	25
BKF210D	25	..	NNNN	BKF310D	25
BKF28AD	25	..	NNNN	BKF38AD	25
BKF251QD	25	..	NNNN	BKF351QD	25
BKF250QD	25	..	NNNN	BKF350QD	25
BKF251WD	25	..	NNNN	BKF351WD	25
BKF250WD	25	..	NNNN	BKF350WD	25

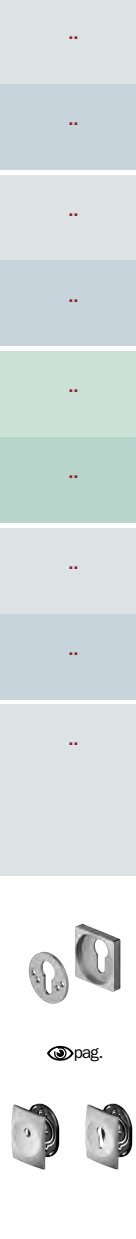

- FINITURE FINISHES**
- C Cromo lucido / Bright Chrome
 - T Cromo satinato / Satin Chrome
 - B Bronzo / Bronze
 - 2 PVD Ottonone / PVD Brass
 - TT Ottonone satinato / Satin Brass
 - BS Bronzo satinato / Satin Bronze
 - IT Inox satinato / Stainless steel

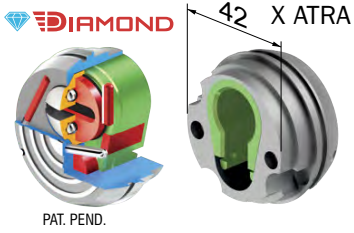

PAT. PEND.

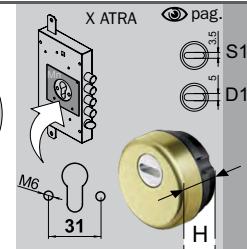
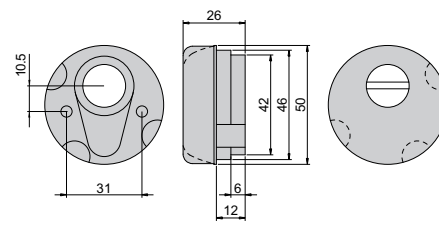
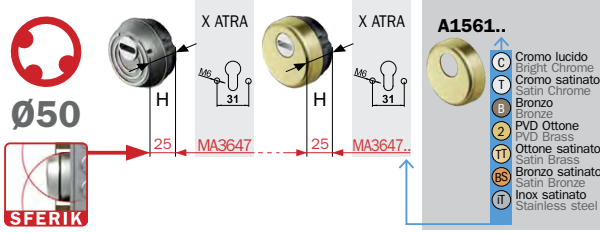

FINITURE FINISHES

- C Cromo lucido Bright Chrome
- T Cromo satinato Satin Chrome
- B Bronzo Bronze
- 2 PVD Ottone PVD Brass
- BS Bronzo satinato Satin Bronze
- IT Inox satinato Stainless steel

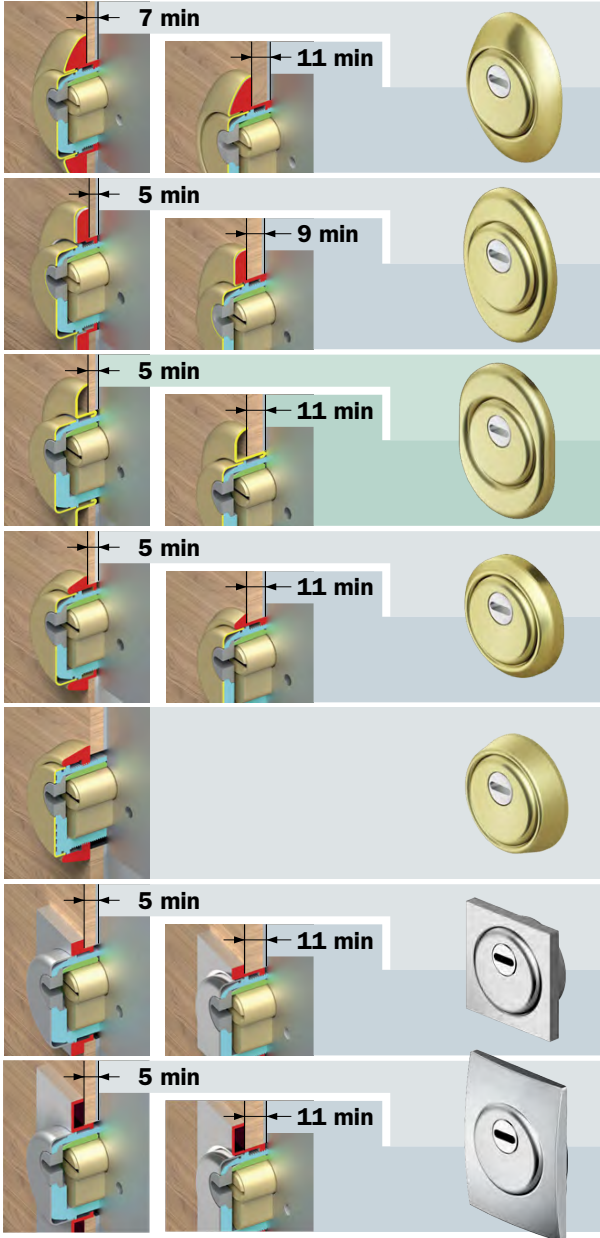
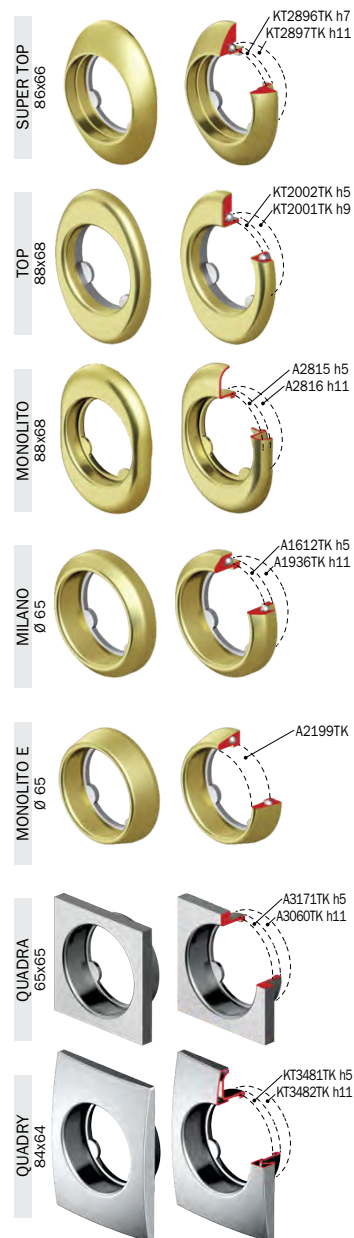

BK321ST	25
BK320ST	25
BK321T	25
BK320T	25
BK321	25
BK320	25
BK321M	25
BK320M	25
BK321E	25
BK321Q	25
BK320Q	25
BK321W	25
BK320W	25



- C Cromo lucido Bright Chrome
- T Cromo satinato Satin Chrome
- B Bronzo Bronze
- 2 PVD Ottone PVD Brass
- BS Bronzo satinato Satin Bronze
- IT Inox satinato Stainless steel



DIAMOND



PAT. PEND.

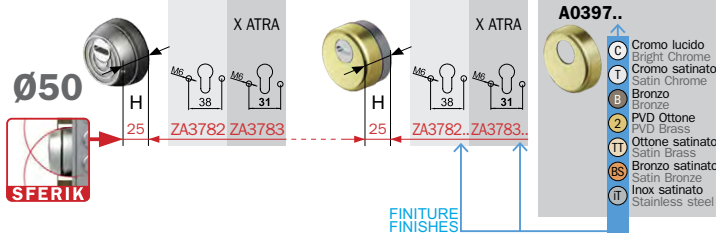

	RKD16 25 .. P		RKD68 25 .. P	RKD16 8 25.. ESEMPIO CODICE	
	RKD16W 25 .. P		RKD68W 25 .. P	ESEMPIO DI CODICE PER VITI M8 EXAMPLE OF CODE FOR FIXING M8	
	RKD16K 25 .. P		RKD68K 25 .. P		

- FINITURE FINISHES
- C Cromo lucido
 - T Bright Chrome
 - S Cromo satinato
 - B Satin Chrome
 - B Bronzo
 - 2 PVD Ottone
 - TT PVD Brass
 - SS Ottone satinato
 - TT Satin Brass
 - SS Bronzo satinato
 - TT Satin Bronze
 - TT Inox satinato
 - TT Stainless Steel



DIAMOND



PAT. PEND.

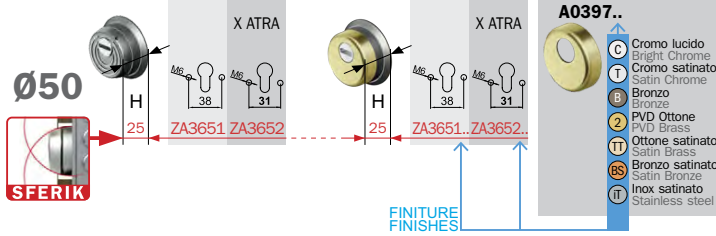

	RKD42 25 .. P		RKD48 25 .. P	RKD42 8 25.. ESEMPIO CODICE	
	RKD42W 25 .. P		RKD48W 25 .. P	ESEMPIO DI CODICE PER VITI M8 EXAMPLE OF CODE FOR FIXING M8	
	RKD42K 25 .. P		RKD48K 25 .. P		

- FINITURE FINISHES
- C Cromo lucido
 - T Bright Chrome
 - S Cromo satinato
 - B Satin Chrome
 - B Bronzo
 - 2 PVD Ottone
 - TT PVD Brass
 - SS Ottone satinato
 - TT Satin Brass
 - SS Bronzo satinato
 - TT Satin Bronze
 - TT Inox satinato
 - TT Stainless Steel

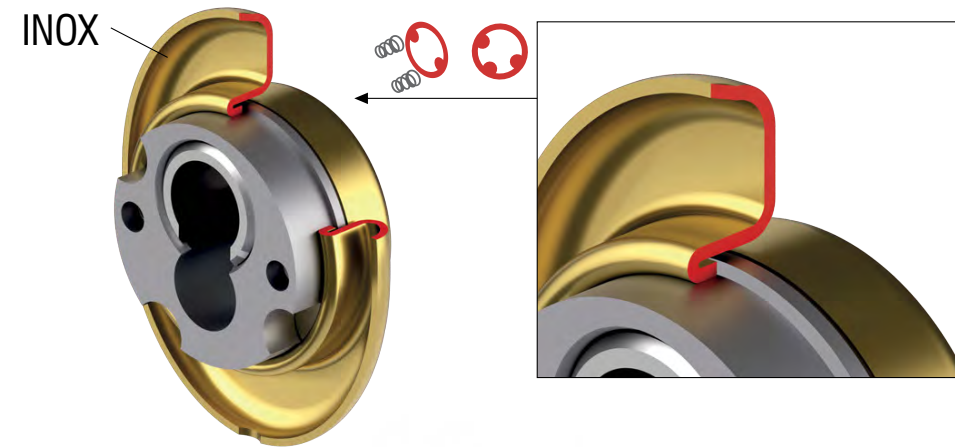
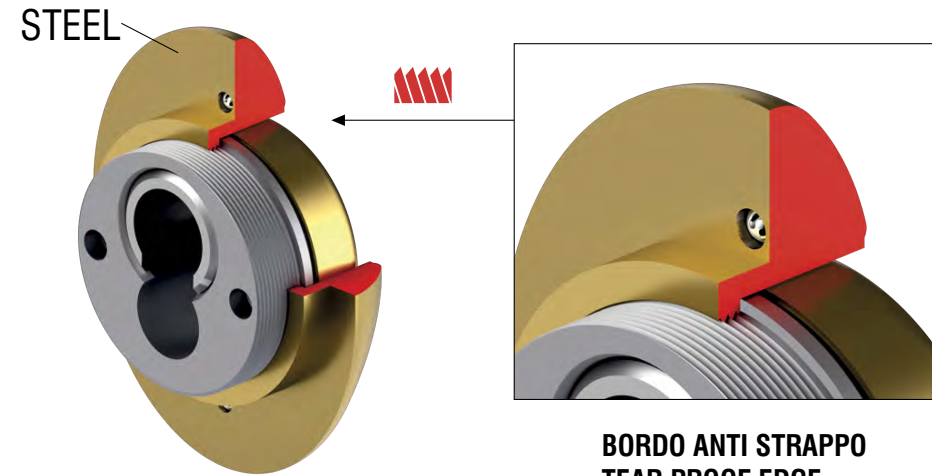
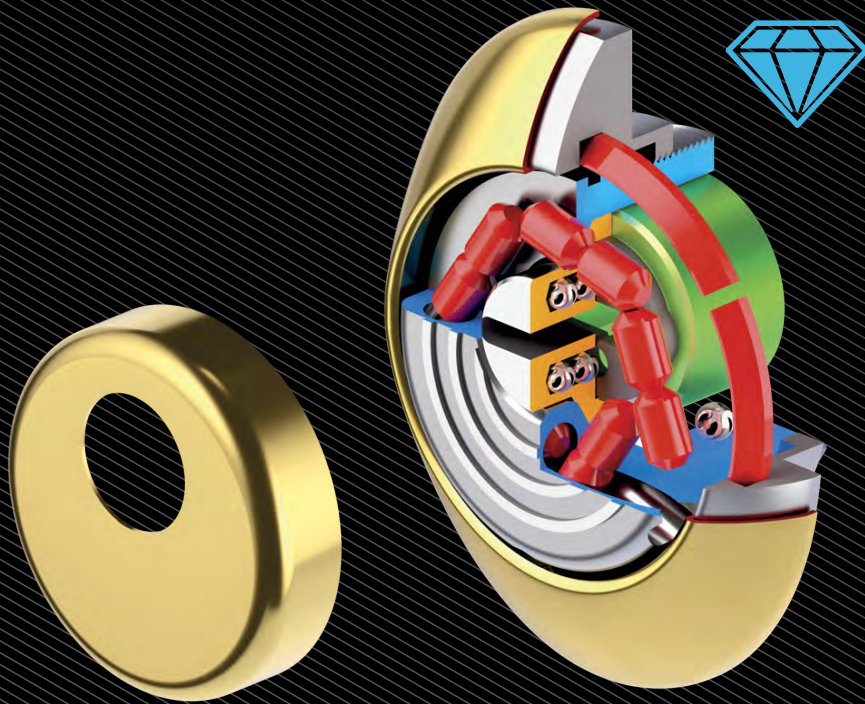

CLS5

NEW REFERENCE TESTED

CLASS 5

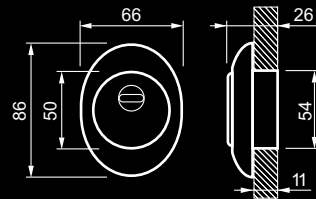

- FINITURE:
FINISHING:
- C** Cromo lucido
Bright Chrome
 - T** Cromo satinato
Satin Chrome
 - B** Bronzo
Bronze
 - 2** PVD Ottone
PVD Brass



SUPER TOP

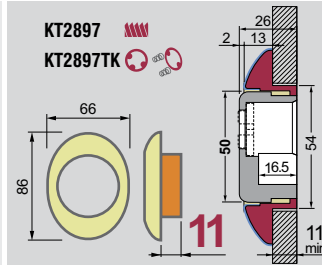
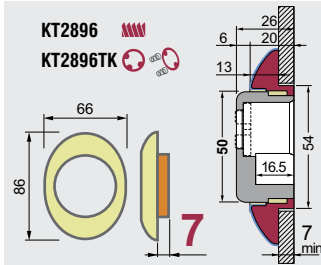

TOP

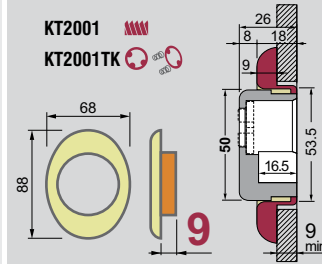
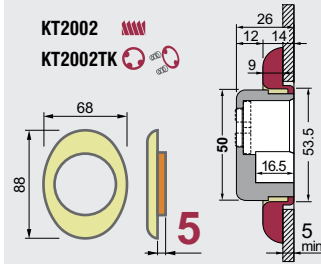

MONOLITO

OPTIONAL
A2073
SPESORE 5mm
SPACER 5mm
PAG

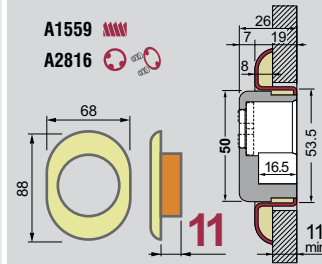
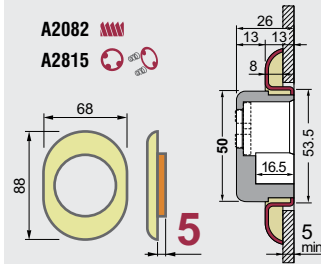

STONE

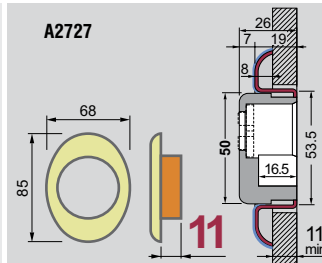
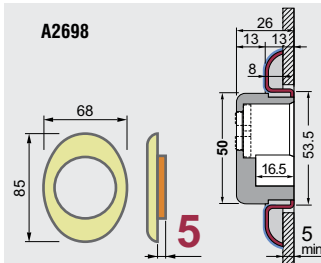

MILANO

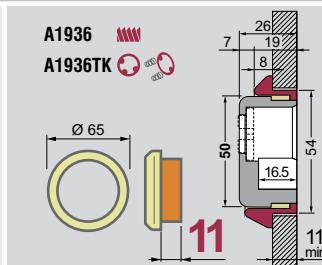
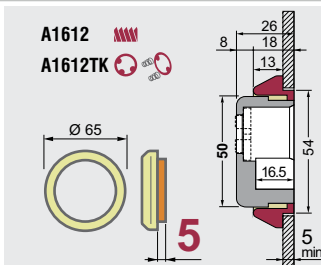

MONOLITO E

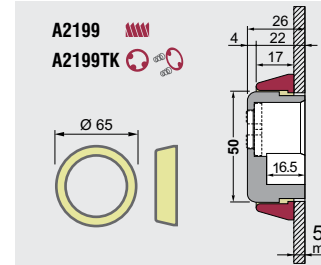

QUADRA

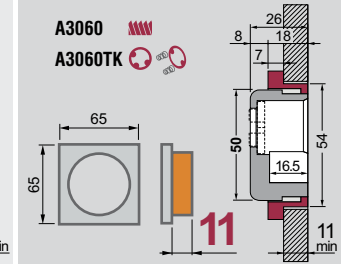
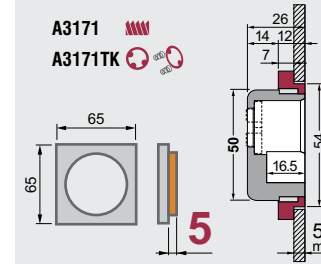

QUADRY

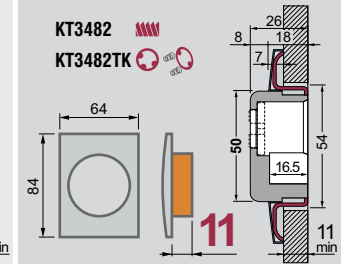
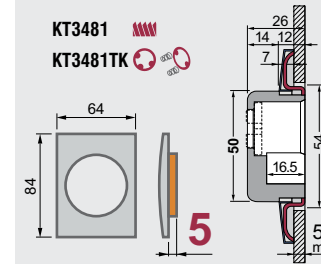

QUADRY P

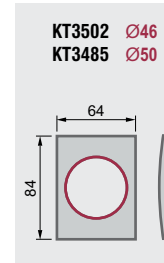

KUBO

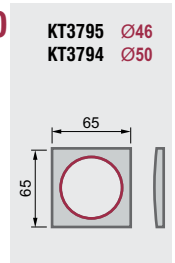

STANDARD

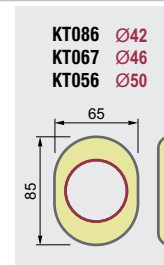

MONOLITO KRIPTON

ROK SFERIK

PAT. PEND.



GRADO 4



PAG

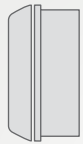

CARBIDE

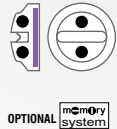

OPTIONAL memory system

Mn CARBIDE



ANTISKETTING system

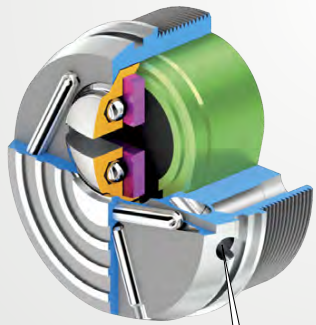

memory system
OPTIONAL

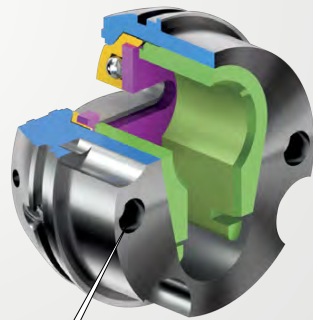

FLEX system

OPTIONAL
MEMORY SYSTEM

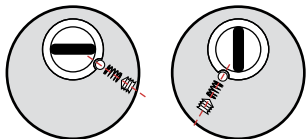

FLEX SYSTEM



5 VOLTE PIU' RESISTENTE DELLE VITI TRADIZIONALI 12.9

MONOLITO KRIPTON



PAG



PAG



PAG

SUPER TOP
86x66



TOP
88x68



MONOLITO
88x68



MILANO
Ø 65



MONOLITO E
Ø 65



QUADRA
65x65



QUADRY
84x64



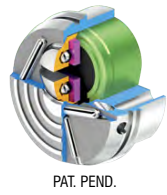

PAT. PEND.

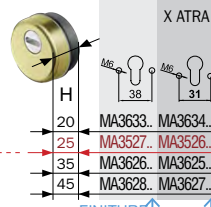
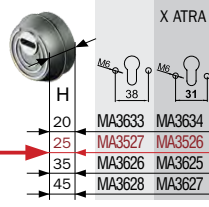

A2209.. H 20
A1561.. H 25/35/45

C	Cromo lucido	Bright Chrome
T	Cromo satinato	Satin Chrome
B	Bronzo	Bronze
2	PVD Ottone	PVD Brass
TT	Ottone satinato	Satin Brass
BS	Bronzo satinato	Satin Bronze
IT	Inox satinato	Stainless steel

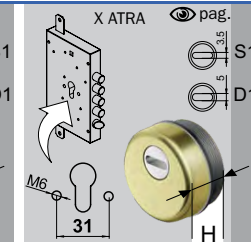
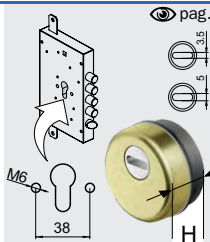

FINITURE FINISHES

C	Cromo lucido	Bright Chrome
T	Cromo satinato	Satin Chrome
B	Bronzo	Bronze
2	PVD Ottone	PVD Brass
TT	Ottone satinato	Satin Brass
BS	Bronzo satinato	Satin Bronze
IT	Inox satinato	Stainless steel

SUPER TOP
56x66

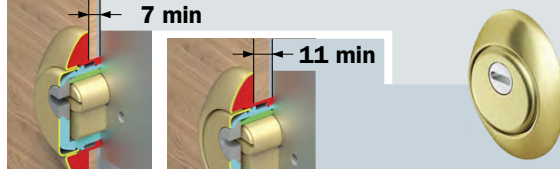
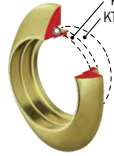

BD291N	20	BD391N	20
BD291N	25	BD391N	25
BD291N	35	BD391N	35
BD291N	45	BD391N	45
BD290N	20	BD390N	20
BD290N	25	BD390N	25
BD290N	35	BD390N	35
BD290N	45	BD390N	45

TOP
88x68

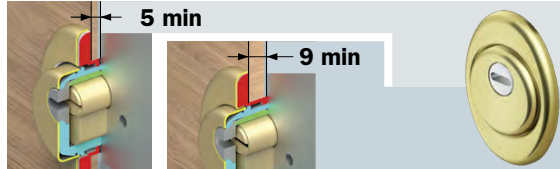
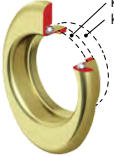

BD271N	20	BD371N	20
BD271N	25	BD371N	25
BD271N	35	BD371N	35
BD271N	45	BD371N	45
BD270N	20	BD370N	20
BD270N	25	BD370N	25
BD270N	35	BD370N	35
BD270N	45	BD370N	45

MONOLITO
88x68

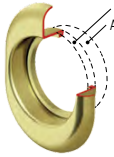

BD251N	20	BD351N	20
BD251N	25	BD351N	25
BD251N	35	BD351N	35
BD251N	45	BD351N	45
BD250N	20	BD350N	20
BD250N	25	BD350N	25
BD250N	35	BD350N	35
BD250N	45	BD350N	45

MILANO
Ø 65

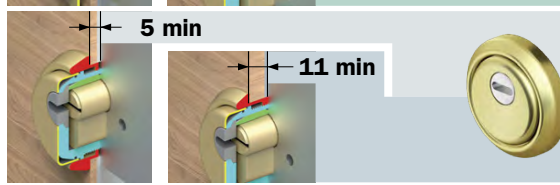

BD261N	20	BD361N	20
BD261N	25	BD361N	25
BD261N	35	BD361N	35
BD261N	45	BD361N	45
BD260N	20	BD360N	20
BD260N	25	BD360N	25
BD260N	35	BD360N	35
BD260N	45	BD360N	45

MONOLITO E
Ø 65

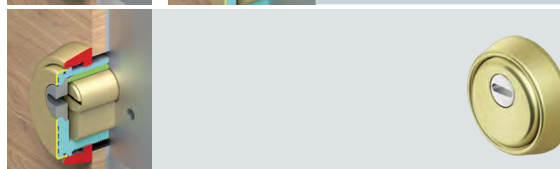
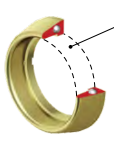

BD28AN	20	BD38AN	20
BD28AN	25	BD38AN	25
BD28AN	35	BD38AN	35
BD28AN	45	BD38AN	45

QUADRA
65x65

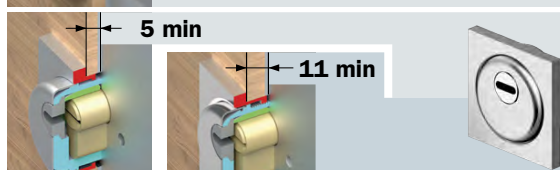
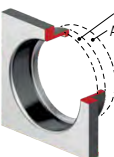

BD251QN	20	BD351QN	20
BD251QN	25	BD351QN	25
BD251QN	35	BD351QN	35
BD251QN	45	BD351QN	45
BD250QN	20	BD350QN	20
BD250QN	25	BD350QN	25
BD250QN	35	BD350QN	35
BD250QN	45	BD350QN	45

QUADRY
84x64

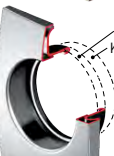

BD251WN	20	BD351WN	20
BD251WN	25	BD351WN	25
BD251WN	35	BD351WN	35
BD251WN	45	BD351WN	45
BD250WN	20	BD350WN	20
BD250WN	25	BD350WN	25
BD250WN	35	BD350WN	35
BD250WN	45	BD350WN	45

ESEMPIO DI CODICE FOR FIXING M8

ESEMPIO DI CODICE PER VITI M8



FINITURE FINISHES

C	Cromo lucido	Bright Chrome
T	Cromo satinato	Satin Chrome
B	Bronzo	Bronze
2	PVD Ottone	PVD Brass
BS	Bronzo satinato	Satin Bronze
IT	Inox satinato	Stainless steel

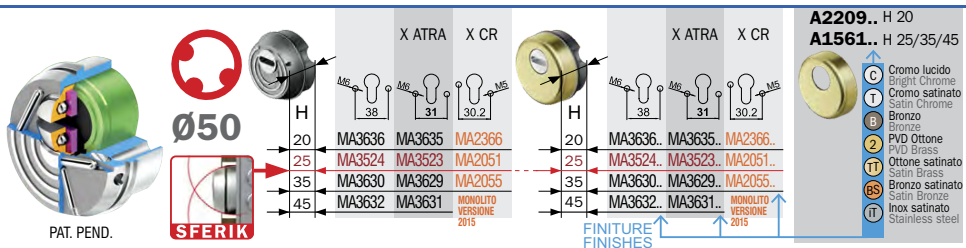

A2209.. H 20
A1561.. H 25/35/45

C	Cromo lucido
T	Bright Chrome
S	Cromo satinato
S	Satin Chrome
B	Bronzo
2	PVD Ottone
2	PVD Brass
TS	Ottone satinato
TS	Satin Brass
BS	Bronzo satinato
BS	Satin Bronze
IT	Inox satinato
IT	Stainless steel

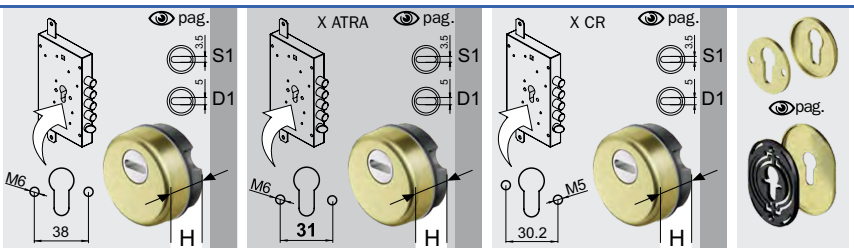

FINITURE FINISHES

C	Cromo lucido
T	Bright Chrome
S	Cromo satinato
S	Satin Chrome
B	Bronzo
2	PVD Ottone
2	PVD Brass
TS	Ottone satinato
TS	Satin Brass
BS	Bronzo satinato
BS	Satin Bronze
IT	Inox satinato
IT	Stainless steel

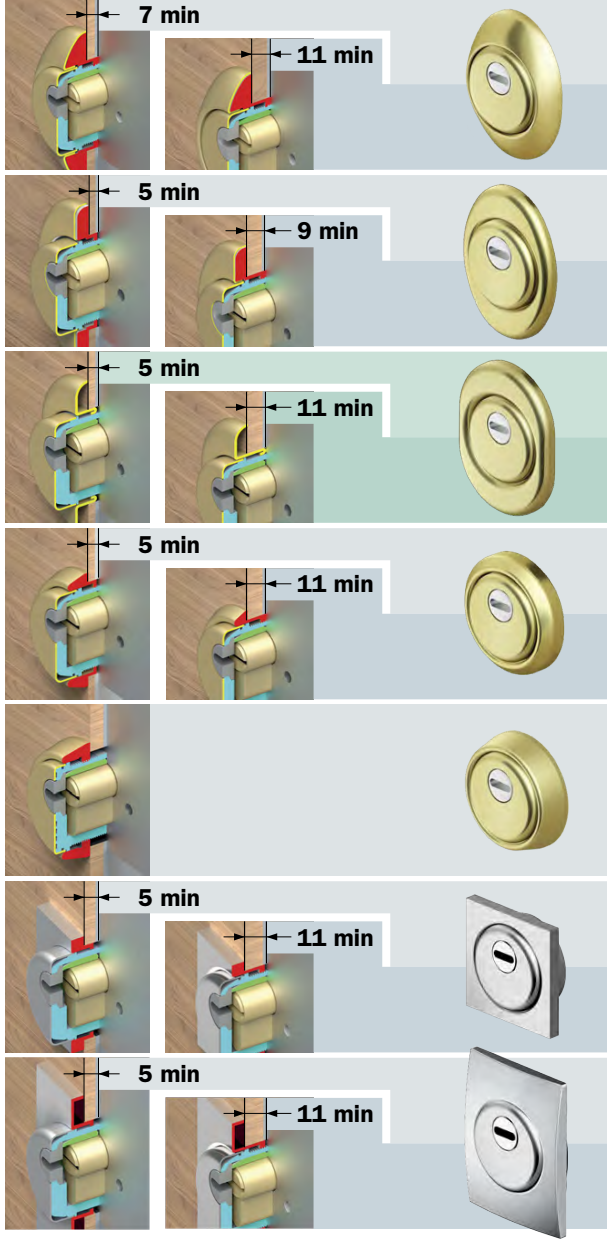
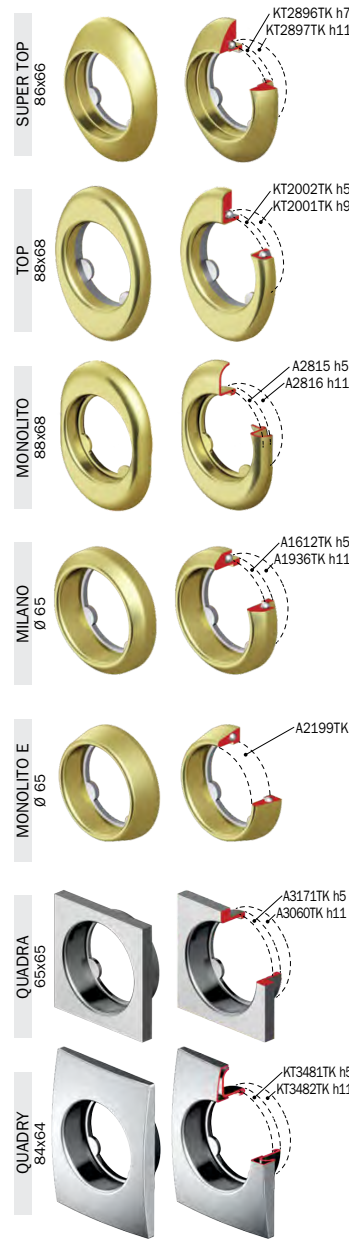

BDT291N	20	BDT391N	20
BDT291N	25	BDT391N	25
BDT291N	35	BDT391N	35
BDT291N	45	BDT391N	45
BDT290N	20	BDT390N	20
BDT290N	25	BDT390N	25
BDT290N	35	BDT390N	35
BDT290N	45	BDT390N	45
BDT271N	20	BDT371N	20
BDT271N	25	BDT371N	25
BDT271N	35	BDT371N	35
BDT271N	45	BDT371N	45
BDT270N	20	BDT370N	20
BDT270N	25	BDT370N	25
BDT270N	35	BDT370N	35
BDT270N	45	BDT370N	45
BD201N	20	BD301N	20
BD201N	25	BD301N	25
BD201N	35	BD301N	35
BD201N	45	BD301N	45
BD200N	20	BD300N	20
BD200N	25	BD300N	25
BD200N	35	BD300N	35
BD200N	45	BD300N	45
BDT211N	20	BDT311N	20
BDT211N	25	BDT311N	25
BDT211N	35	BDT311N	35
BDT211N	45	BDT311N	45
BDT210N	20	BDT310N	20
BDT210N	25	BDT310N	25
BDT210N	35	BDT310N	35
BDT210N	45	BDT310N	45
BDT28AN	20	BDT38AN	20
BDT28AN	25	BDT38AN	25
BDT28AN	35	BDT38AN	35
BDT28AN	45	BDT38AN	45
BDT251QN	20	BDT351QN	20
BDT251QN	25	BDT351QN	25
BDT251QN	35	BDT351QN	35
BDT251QN	45	BDT351QN	45
BDT250QN	20	BDT350QN	20
BDT250QN	25	BDT350QN	25
BDT250QN	35	BDT350QN	35
BDT250QN	45	BDT350QN	45
BDT251WN	20	BDT351WN	20
BDT251WN	25	BDT351WN	25
BDT251WN	35	BDT351WN	35
BDT251WN	45	BDT351WN	45
BDT250WN	20	BDT350WN	20
BDT250WN	25	BDT350WN	25
BDT250WN	35	BDT350WN	35
BDT250WN	45	BDT350WN	45

BD401	20
BD401	25
BD401	35
BD400	20
BD400	25
BD400	35

MONOLITO VERSIONE 2015

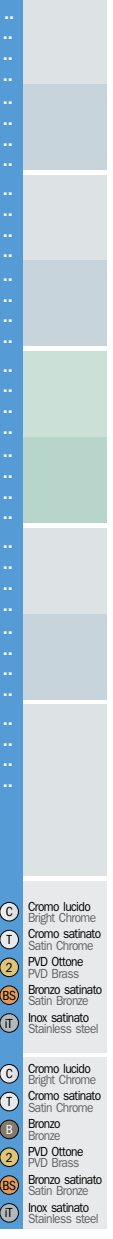

FINITURE FINISHES

C	Cromo lucido
T	Bright Chrome
S	Cromo satinato
S	Satin Chrome
B	Bronzo
2	PVD Ottone
2	PVD Brass
TS	Ottone satinato
TS	Satin Brass
BS	Bronzo satinato
BS	Satin Bronze
IT	Inox satinato
IT	Stainless steel

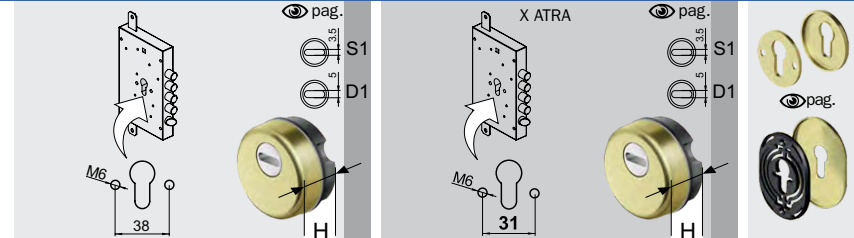
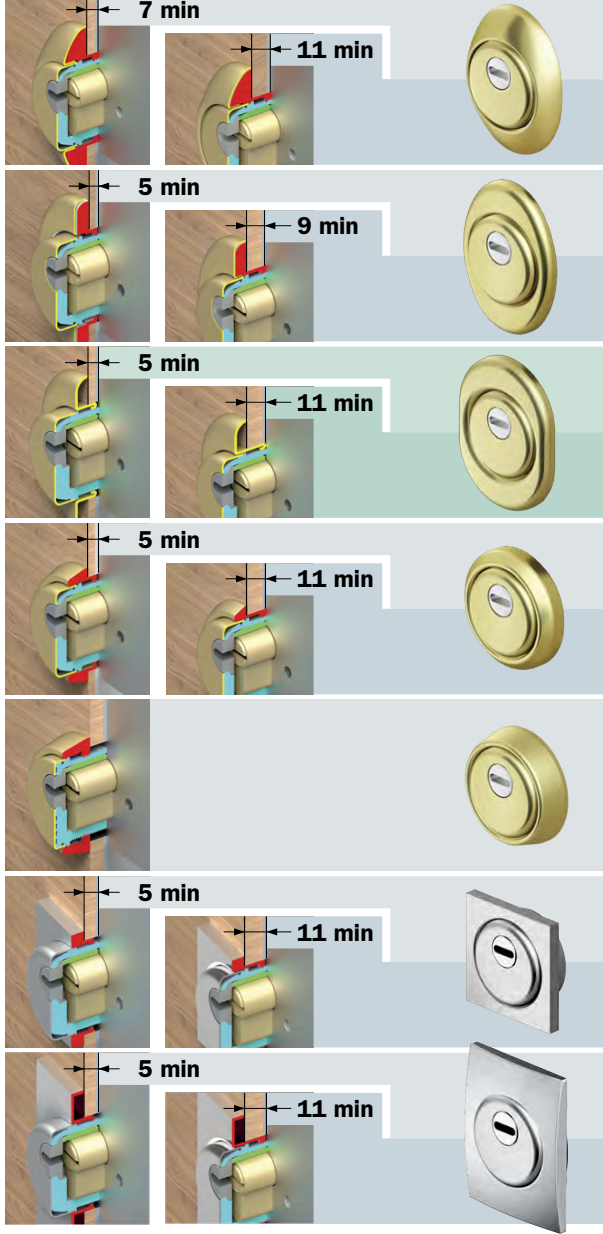
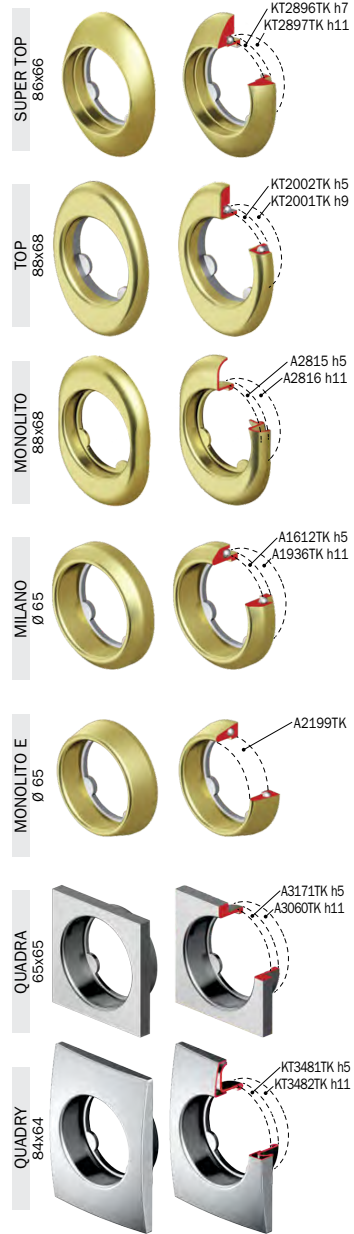
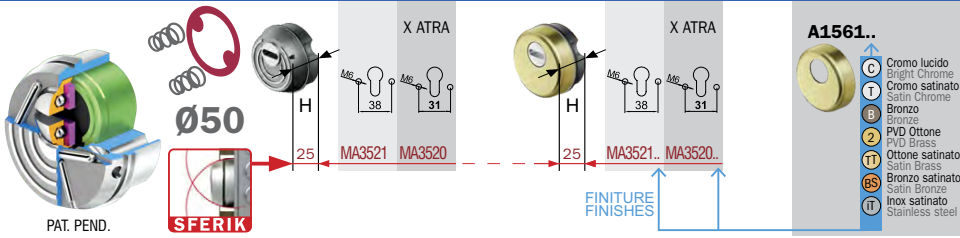

BFT291	25
BFT290	25
BFT271	25
BFT270	25
BF201	25
BF200	25
BFT211	25
BFT210	25
BFT28A	25
BFT251Q	25
BFT250Q	25
BFT251W	25
BFT250W	25

FINITURE FINISHES

C	Cromo lucido	Bright Chrome
T	Cromo satinato	Satin Chrome
B	Bronzo	Bronze
2	PVD Otone	PVD Brass
BS	Bronzo satinato	Satin Bronze
IT	Inox satinato	Satin Stainless steel
IT	Inox satinato	Stainless steel

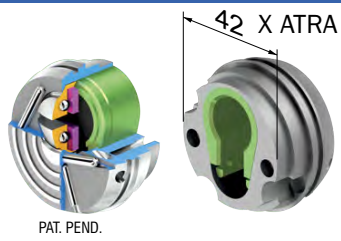

PAT. PEND.

42 X ATRA



Ø50

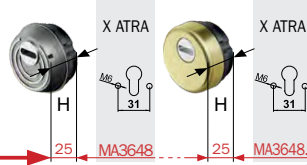

- A1561..**
- 1 Cromo lucido Bright Chrome
 - 1 Cromo satinato Satin Chrome
 - 2 Bronzo Bronze
 - 2 PVD Ottone PVD Brass
 - 11 Ottone satinato Satin Brass
 - BS Bronzo satinato Satin Bronze
 - IT Inox satinato Stainless steel

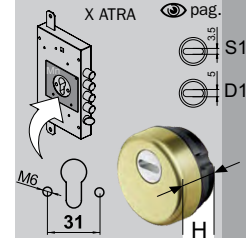
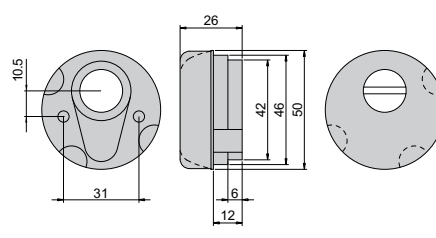

- FINITURE FINISHES**
- C Cromo lucido Bright Chrome
 - T Cromo satinato Satin Chrome
 - B Bronzo Bronze
 - 2 PVD Ottone PVD Brass
 - 11 Ottone satinato Satin Brass
 - BS Bronzo satinato Satin Bronze
 - IT Inox satinato Stainless steel

SUPER TOP
56x66

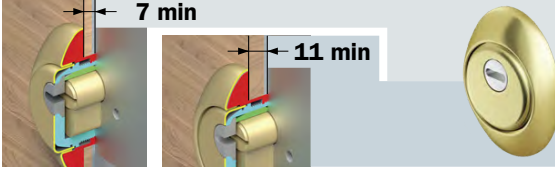
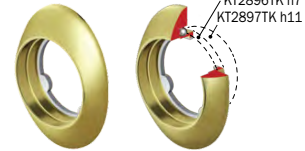

BD321ST 25

BD320ST 25

TOP
88x68

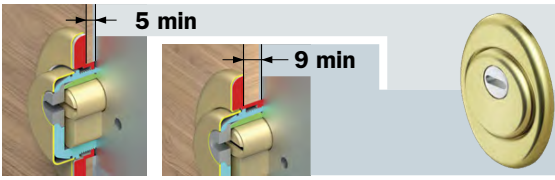
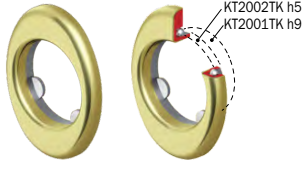

BD321T 25

BD320T 25

MONOLITO
88x68

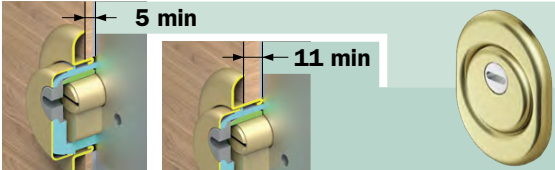
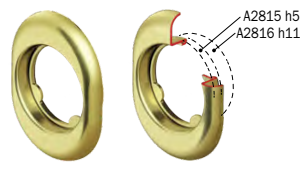

BD321N 25

BD320N 25

MILANO
Ø 65

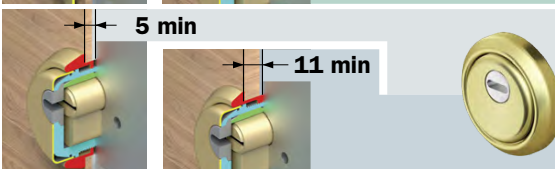
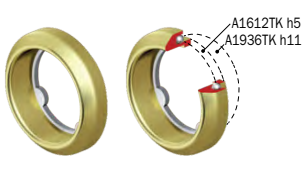

BD321M 25

BD320M 25

MONOLITO E
Ø 65

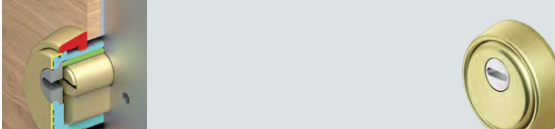
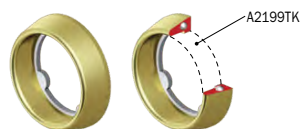

BD321E 25

QUADRA
65x65

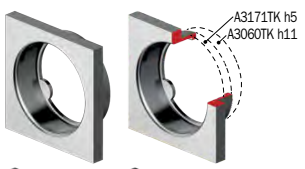

BD321Q 25

BD320Q 25

QUADRY
84x64

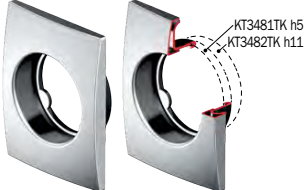

BD321W 25

BD320W 25

SUPER TOP

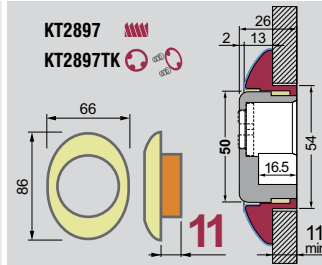
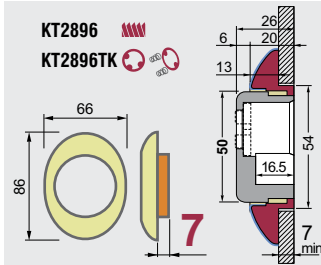

TOP

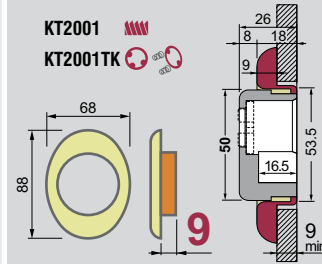
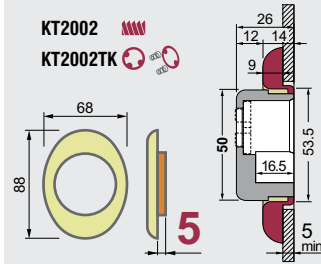

MONOLITO

OPTIONAL
A2073
SPESORE 5mm
SPACER 5mm
PAG

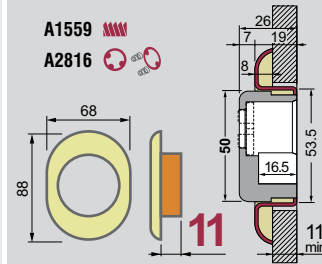
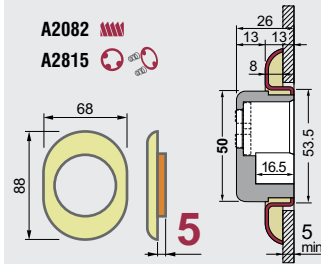

STONE

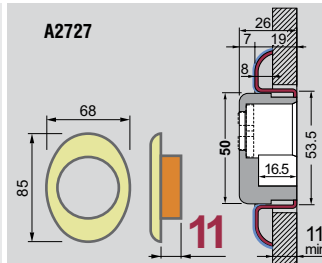
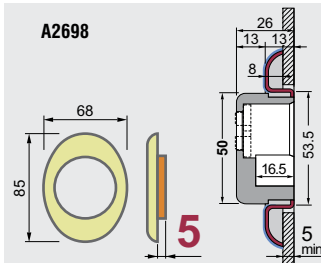

MILANO

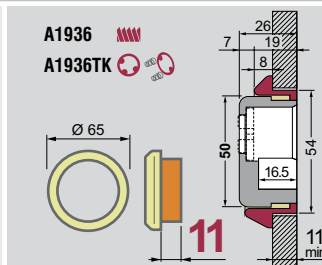
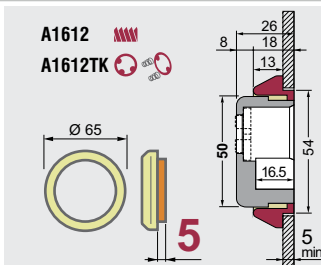

MONOLITO E

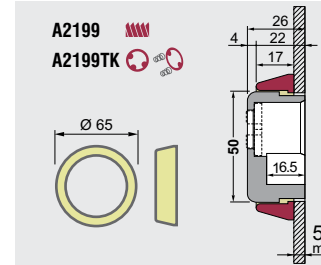

QUADRA

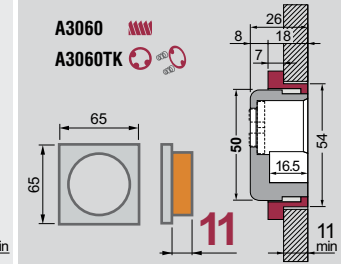
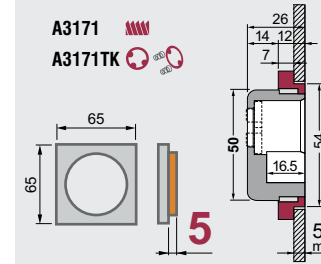

QUADRY

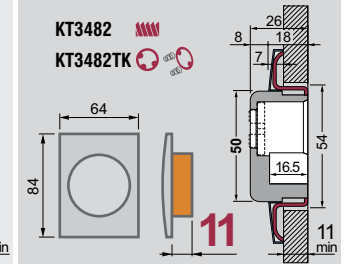
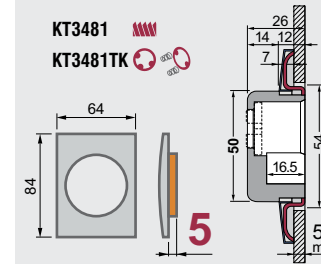

QUADRY P

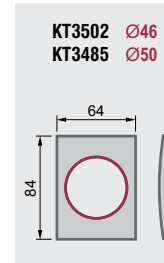

KUBO

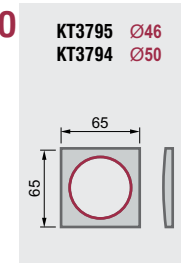

STANDARD

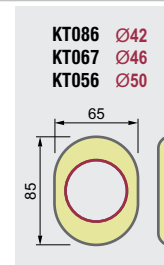

MONOLITO ROK SFERIK

PAT. PEND.



GRADO 4

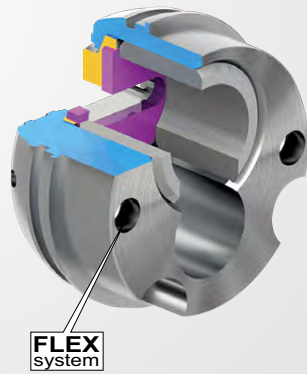
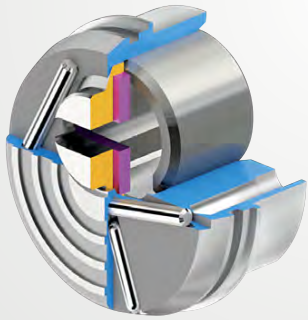
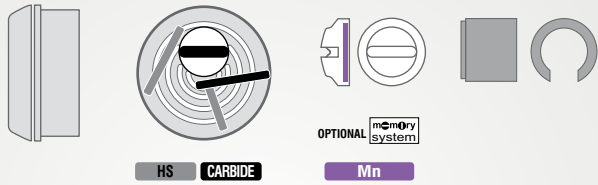

OPTIONAL
MEMORY SYSTEM

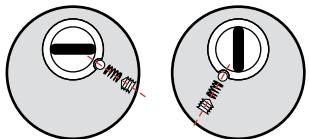

FLEX SYSTEM



5 VOLTE PIU' RESISTENTE DELLE VITI TRADIZIONALI 12.9

MONOLITO



MONOLITO
88x68

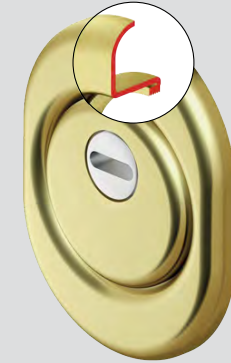

QUADRY
84x64



FILETTATO
Ø50

PAT. PEND.

SFERIK

X ATRA

MA2371 MA2372
MA2665 MA2731
MA1927 MA1928
MA2702

X ATRA

MA2371.. MA2372..
MA2665.. MA2731..
MA1927.. MA1928..
MA2702..

A2209.. H 20
A1561.. H 25/35/45

Cromo lucido
Bright Chrome
Cromo satinato
Satin Chrome
Bronzo
Bronze
PVD Ottone
PVD Brass
Ottone satinato
Satin Brass
Bronzo satinato
Satin Bronze
Inox satinato
Stainless steel

pag. S1 D1

X ATRA pag. S1 D1

BD251 20
BD251 25
BD251 35
BD251 45
BD250 20
BD250 25
BD250 35
BD250 45

BD351 20
BD351 25
BD351 35
BD350 20
BD350 25
BD350 35

BD251W 20
BD251W 25
BD251W 35
BD251W 45
BD250W 20
BD250W 25
BD250W 35
BD250W 45

BD351W 20
BD351W 25
BD351W 35
BD350W 20
BD350W 25
BD350W 35

ESEMPLO DI CODICE PER VITI M8
EXAMPLE OF CODE FOR FIXING M8

BD251 20

FINITURE FINISHES

Cromo lucido
Bright Chrome
Cromo satinato
Satin Chrome
Bronzo
Bronze
PVD Ottone
PVD Brass
Ottone satinato
Satin Brass
Bronzo satinato
Satin Bronze
Inox satinato
Stainless steel

FILETTATO
Ø50

PAT. PEND.

SFERIK

X ATRA

MA2365 MA2367
MA2871 MA2052
MA2053 MA2054
MA2685

X ATRA

MA2365.. MA2367..
MA2871.. MA2052..
MA2053.. MA2054..
MA2685..

A2209.. H 20
A1561.. H 25/35/45

Cromo lucido
Bright Chrome
Cromo satinato
Satin Chrome
Bronzo
Bronze
PVD Ottone
PVD Brass
Ottone satinato
Satin Brass
Bronzo satinato
Satin Bronze
Inox satinato
Stainless steel

pag. S1 D1

X ATRA pag. S1 D1

BD201 20
BD201 25
BD201 35
BD201 45
BD200 20
BD200 25
BD200 35
BD200 45

BD301 20
BD301 25
BD301 35
BD300 20
BD300 25
BD300 35

BDT251W 20
BDT251W 25
BDT251W 35
BDT251W 45
BDT250W 20
BDT250W 25
BDT250W 35
BDT250W 45

BDT351W 20
BDT351W 25
BDT351W 35
BDT350W 20
BDT350W 25
BDT350W 35

ESEMPLO DI CODICE PER VITI M8
EXAMPLE OF CODE FOR FIXING M8

BD201 20

FINITURE FINISHES

Cromo lucido
Bright Chrome
Cromo satinato
Satin Chrome
Bronzo
Bronze
PVD Ottone
PVD Brass
Ottone satinato
Satin Brass
Bronzo satinato
Satin Bronze
Inox satinato
Stainless steel

FILETTATO
Ø50

PAT. PEND.

SFERIK

X ATRA

MA3817 MA3818

X ATRA

MA3817.. MA3818..

A2209.. H 20
A1561.. H 25/35/45

Cromo lucido
Bright Chrome
Cromo satinato
Satin Chrome
Bronzo
Bronze
PVD Ottone
PVD Brass
Ottone satinato
Satin Brass
Bronzo satinato
Satin Bronze
Inox satinato
Stainless steel

pag. S1 D1

X ATRA pag. S1 D1

BDF201 25
BDF200 25
BDF251W 25
BDF250W 25

BDF301 25
BDF300 25
BDF351W 25
BDF350W 25

MONO

MONO

ESEMPLO DI CODICE PER VITI M8
EXAMPLE OF CODE FOR FIXING M8

BD201 20

FINITURE FINISHES

Cromo lucido
Bright Chrome
Cromo satinato
Satin Chrome
Bronzo
Bronze
PVD Ottone
PVD Brass
Ottone satinato
Satin Brass
Bronzo satinato
Satin Bronze
Inox satinato
Stainless steel

SUPER TOP

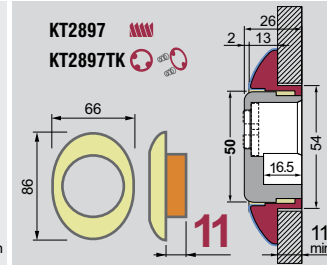
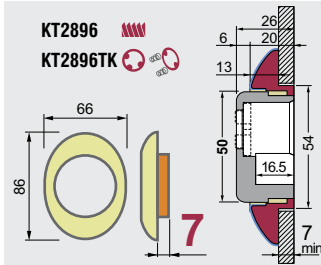

TOP

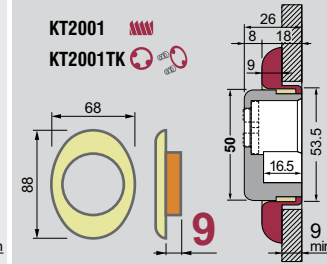
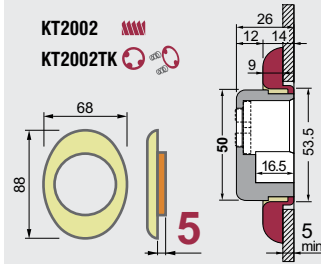

MONOLITO

OPTIONAL
A2073
SPESORE 5mm
SPACER 5mm
PAG

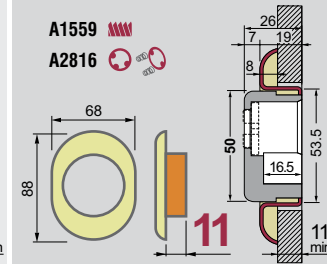
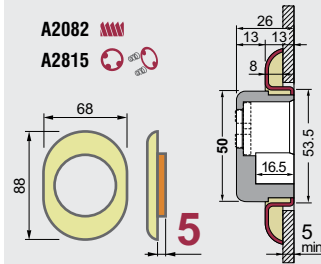

STONE

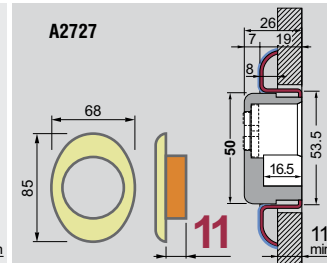
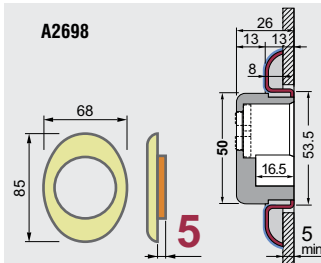

MILANO

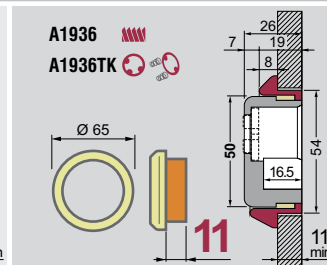
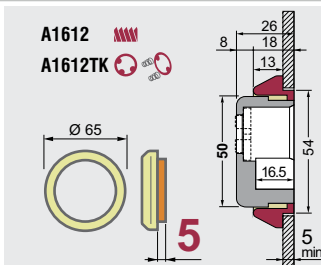

MONOLITO E

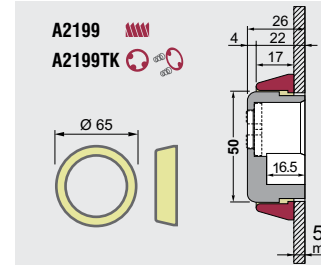

QUADRA

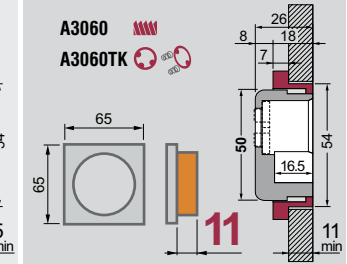
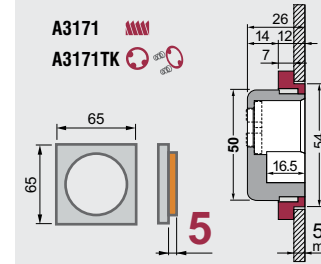

QUADRY

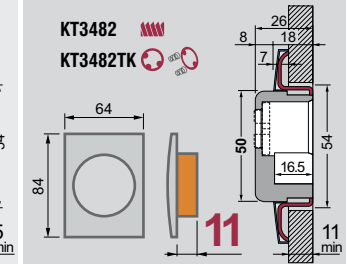
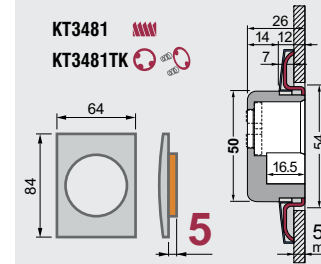

QUADRY P

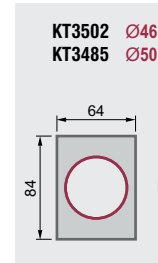

KUBO

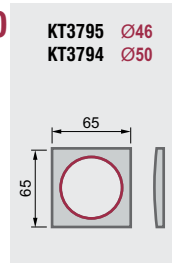

STANDARD

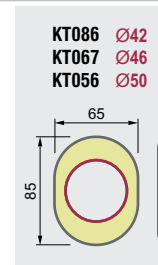

FILETTATO
Ø50

FINITURE FINISHES

- C Cromo lucido Bright Chrome
- T Cromo satinato Satin Chrome
- B Bronzo Bronze
- Z PVD Ottone PVD Brass
- II Inox satinato Stainless steel

MA3086..

- C Cromo lucido Bright Chrome
- T Cromo satinato Satin Chrome
- B Bronzo Bronze
- Z PVD Ottone PVD Brass
- II Inox satinato Stainless steel

X OMEGA

7 min

11 min

BD10800STB ..
BD10800STA ..

5 min

9 min

BD10800TB ..
BD10800TA ..

5 min

11 min

BD10800B ..
BD10800A ..

5 min

11 min

BD10800MB ..
BD10800MA ..

5 min

11 min

BD10800E ..

5 min

11 min

BD10800QB ..
BD10800QA ..

5 min

11 min

BD10800WB ..
BD10800WA ..

pag.

Ø50

MA3645..

- C Cromo lucido Bright Chrome
- T Cromo satinato Satin Chrome
- B Bronzo Bronze
- Z PVD Ottone PVD Brass
- II Inox satinato Stainless steel

X OMEGA

FINITURE FINISHES

- C Cromo lucido Bright Chrome
- T Cromo satinato Satin Chrome
- B Bronzo Bronze
- Z PVD Ottone PVD Brass
- II Inox satinato Stainless steel

A3375 2mm ±2mm

PER TUTTE LE VERSIONI

INOX

BORDO ANTISTRAPPO

5 min

11 min

BDF10800B ..
NNN
BDF10800A ..

5 min

11 min

BDF10800QB ..
NNN
BDF10800QA ..

5 min

11 min

BDF10800WB ..
NNN
BDF10800WA ..

pag.

RKD

ROK SFERIK

DIAMOND

PAT. PEND.



PAG



GRADO 4

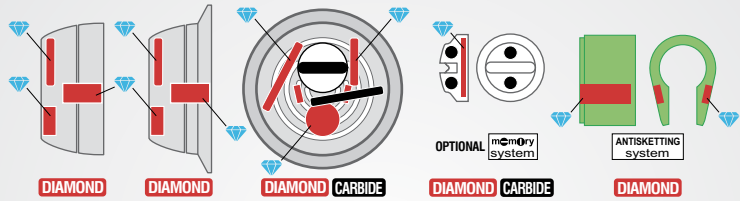

OPTIONAL
MEMORY SYSTEM

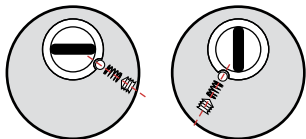

FLEX SYSTEM



RWS

ROK SFERIK

PAT. PEND.



PAG



GRADO 4

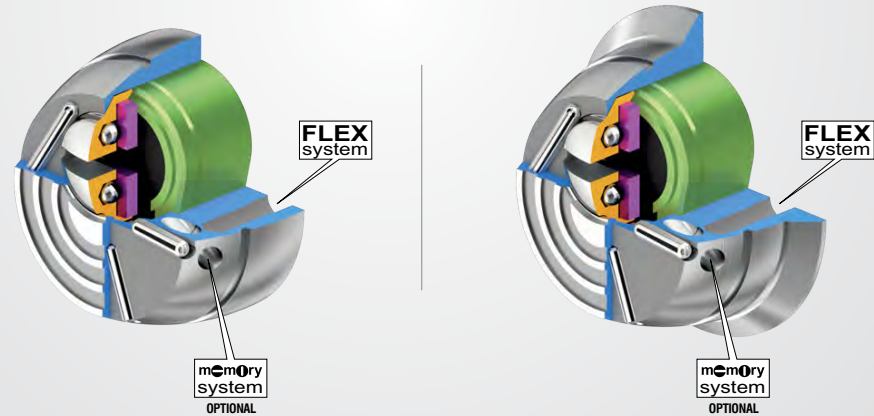
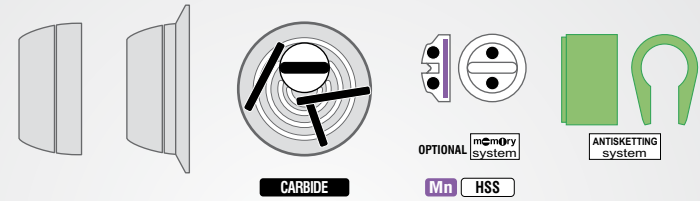

OPTIONAL
MEMORY SYSTEM

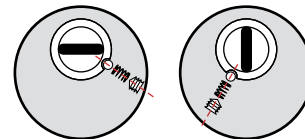

FLEX SYSTEM



RWS ROK



PAT. PEND.

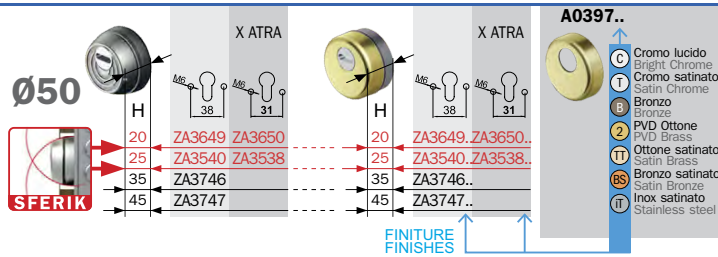

FINITURE FINISHES

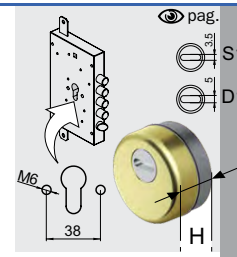

RWS16 20 .. P

RWS16 25 .. P

RWS16 35 .. P

RWS16 45 .. P

RWS68 20 .. P

RWS68 25 .. P

RWS16 8 25..

ESEMPIO CODICE

..

..

..

RWS16W 20 .. P

RWS16W 25 .. P

RWS16W 35 .. P

RWS16W 45 .. P

RWS68W 20 .. P

RWS68W 25 .. P



ESEMPIO DI CODICE PER VITI M8

EXAMPLE OF CODE FOR VING M8

RWS16K 20 .. P

RWS16K 25 .. P

RWS16K 35 .. P

RWS16K 45 .. P

RWS68K 20 .. P

RWS68K 25 .. P

- FINITURE FINISHES
- C Cromo lucido
 - T Bright Chrome
 - C Cromo satinato
 - S Satin Chrome
 - B Bronzo
 - Z PVD Ottone
 - 2 PVD Brass
 - TT Ottone satinato
 - S Satin Brass
 - SS Bronzo satinato
 - IT Satin Bronze
 - IT Inox satinato
 - IT Stainless Steel

RWS ROK

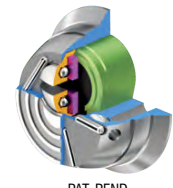

PAT. PEND.

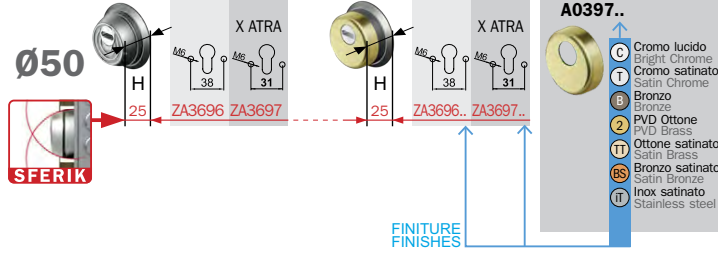

FINITURE FINISHES

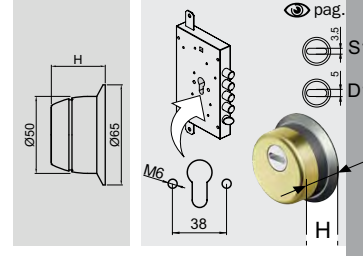

RWS42 25 .. P

RWS48 25 .. P

RWS42 8 25..

ESEMPIO CODICE

..

..

RWS42W 25 .. P

RWS48W 25 .. P

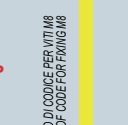

ESEMPIO DI CODICE PER VITI M8

EXAMPLE OF CODE FOR VING M8

RWS42K 25 .. P

RWS48K 25 .. P

- FINITURE FINISHES
- C Cromo lucido
 - T Bright Chrome
 - C Cromo satinato
 - S Satin Chrome
 - B Bronzo
 - Z PVD Ottone
 - 2 PVD Brass
 - TT Ottone satinato
 - S Satin Brass
 - SS Bronzo satinato
 - IT Satin Bronze
 - IT Inox satinato
 - IT Stainless Steel

STONE ROK SFERIK

PAT. PEND.

memory system OPTIONAL
FLEX system



PAG

85x68



GRADO 4

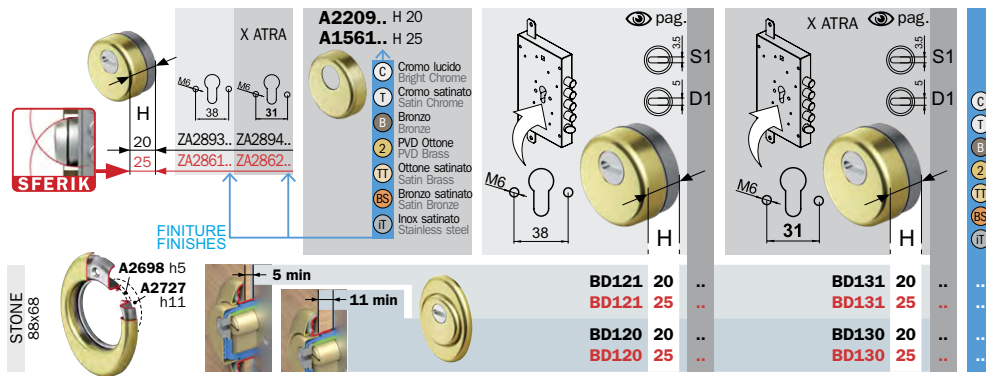
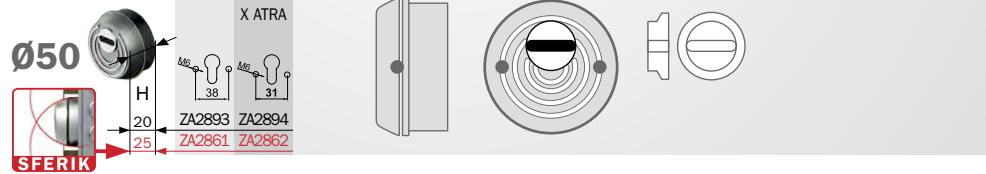
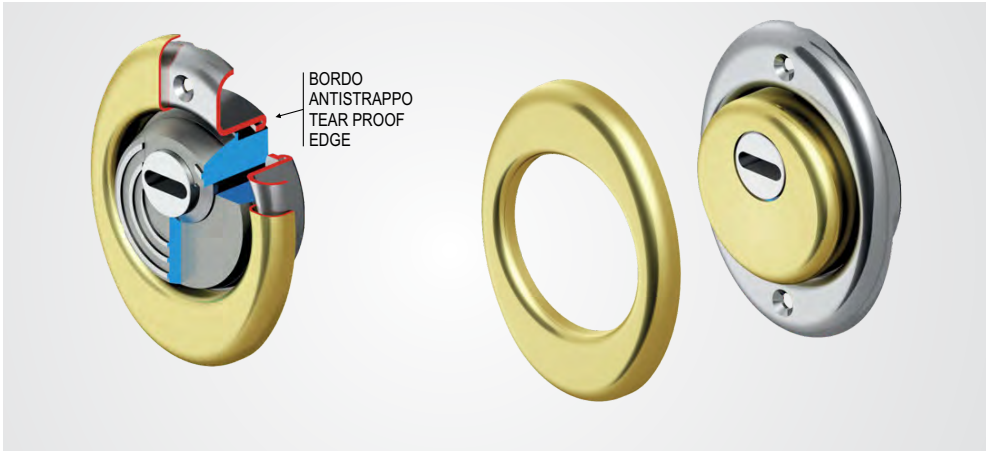

OPTIONAL
MEMORY SYSTEM

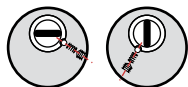

FLEX SYSTEM



5 VOLTE PIU' RESISTENTE DELLE VITI TRADIZIONALI 12.9

BDS ROK SFERIK

PAT. PEND.

memory system OPTIONAL
FLEX system

GRADO 4

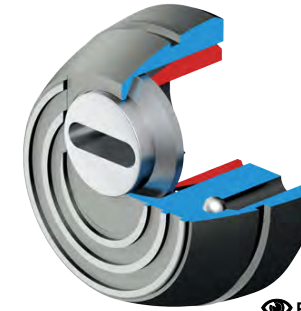

PAG

STANDARD

85x65

QUADRY

84x64

KUBO

65x65



RB ROK SFERIK

PAT. PEND.

memory system OPTIONAL
FLEX system

GRADO 4



PAG

STANDARD

85x65

QUADRY

84x64

KUBO

65x65



OPTIONAL
MEMORY SYSTEM

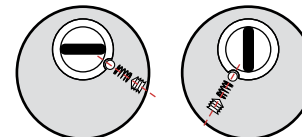

FLEX SYSTEM



5 VOLTE PIU' RESISTENTE DELLE VITI TRADIZIONALI 12.9

RB ROK



PAT. PEND.

Ø50



X ATRA		X ATRA	
25	ZA2384 ZA2458	25	ZA2384.. ZA2458..
35	ZA2632 ZA2127	35	ZA2632.. ZA2127..
45	ZA2126	45	ZA2126..
55	ZA2946	55	ZA2946..
65	ZA2947	65	ZA2947..
70	ZA2948 ZA2990	70	ZA2948.. ZA2990..

A0397..

C	Cromo lucido
T	Bright Chrome
S	Cromo satinato
S	Satin Chrome
B	Bronzo
2	PVD Ottono
2	PVD Brass
TT	Ottone satinato
TT	Satin Brass
BS	Bronzo satinato
BS	Satin Bronze
IT	Inox satinato
IT	Stainless steel

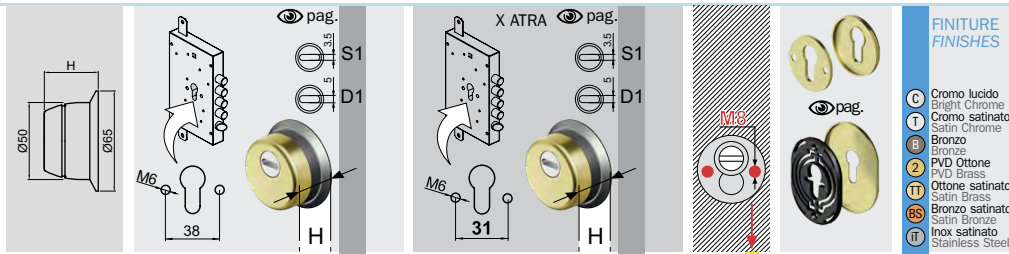

- FINITURE FINISHES**
- C Cromo lucido
 - T Bright Chrome
 - S Cromo satinato
 - S Satin Chrome
 - B Bronzo
 - 2 PVD Ottono
 - 2 PVD Brass
 - TT Ottone satinato
 - TT Satin Brass
 - BS Bronzo satinato
 - BS Satin Bronze
 - IT Inox satinato
 - IT Stainless Steel



Model	Height (H)	Finish	Example Code
RBS42	25	P	RBS42 8 25..
RB42	35	P	..
RB42	45	P	..
RB42	55	P	..
RB42	65	P	..
RB42	70	P	..
RBS42W	25	P	..
RB42W	35	P	..
RB42W	45	P	..
RB42W	55	P	..
RB42W	65	P	..
RB42W	70	P	..
RBS42K	25	P	..
RB42K	35	P	..
RB42K	45	P	..
RB42K	55	P	..
RB42K	65	P	..
RB42K	70	P	..
RBS48	25	P	..
RB48	35	P	..
RB48	70	P	..
RBS48W	25	P	..
RB48W	35	P	..
RB48W	70	P	..
RBS48K	25	P	..
RB48K	35	P	..
RB48K	70	P	..

RBXPAS



Ø46

X ATRA		X ATRA	
38	ZA1986	38	ZA1986..
48	ZA1987	48	ZA1987..
58	ZA1988	58	ZA1988..

A1663..

C	Cromo lucido
T	Bright Chrome
S	Cromo satinato
S	Satin Chrome
B	Bronzo
2	PVD Ottono
2	PVD Brass
TT	Ottone satinato
TT	Satin Brass
BS	Bronzo satinato
BS	Satin Bronze
IT	Inox satinato
IT	Stainless steel

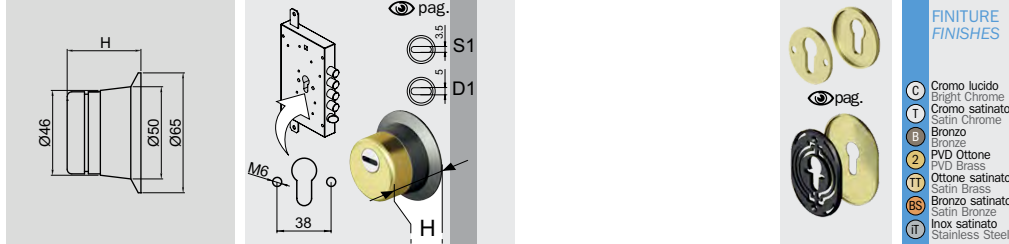

- FINITURE FINISHES**
- C Cromo lucido
 - T Bright Chrome
 - S Cromo satinato
 - S Satin Chrome
 - B Bronzo
 - 2 PVD Ottono
 - 2 PVD Brass
 - TT Ottone satinato
 - TT Satin Brass
 - BS Bronzo satinato
 - BS Satin Bronze
 - IT Inox satinato
 - IT Stainless Steel



Model	Height (H)	Finish	Example Code
PAS	38	P	..
PAS	48	P	..
PAS	58	P	..
PASW	38	P	..
PASW	48	P	..
PASW	58	P	..
PASK	38	P	..
PASK	48	P	..
PASK	58	P	..



PAT. PEND.

Ø50

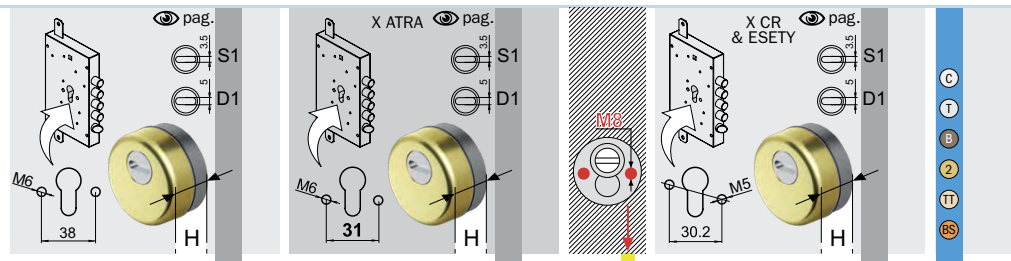
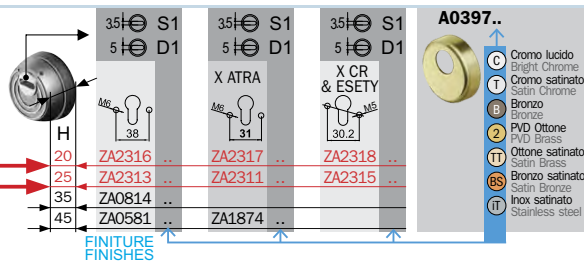

	BDS16 20 .. P	BDS68 20 .. P	BDS16 8 20..	BDS61 20 .. P	
	BDS16 25 .. P	BDS68 25 .. P	ESEMPIO CODICE	BDS61 25 .. P	
	BD16 35 .. P	BD68 45 .. P			
	BD16 45 .. P				
	BDS16 20 .. PP	BDS68 20 .. PP	EXAMPLE OF CODE FOR FIXING M8	BDS61 20 .. PP	
	BDS16 25 .. PP	BDS68 25 .. PP		BDS61 25 .. PP	
	BD16 35 .. PP	BD68 45 .. PP			
	BD16 45 .. PP				
	BDS16 20 ..	BDS68 20 ..		BDS61 20 ..	
	BDS16 25 ..	BDS68 25 ..		BDS61 25 ..	
	BD16 35 ..	BD68 45 ..			
	BD16 45 ..				
	BDS16 20 .. M	BDS68 20 .. M	ESEMPIO DI CODICE PER VITI M8	BDS61 20 .. M	
	BDS16 25 .. M	BDS68 25 .. M		BDS61 25 .. M	
	BD16 35 .. M	BD68 45 .. M			
	BD16 45 .. M				
	BDS16 20 .. W	BDS68 20 .. W		BDS61 20 .. W	
	BDS16 25 .. W	BDS68 25 .. W		BDS61 25 .. W	
	BD16 35 .. W	BD68 45 .. W			
	BD16 45 .. W				
	BDS16 20 .. WP	BDS68 20 .. WP		BDS61 20 .. WP	
	BDS16 25 .. WP	BDS68 25 .. WP		BDS61 25 .. WP	
	BD16 35 .. WP	BD68 45 .. WP			
	BD16 45 .. WP				
	BDS16 20 .. K	BDS68 20 .. K		BDS61 20 .. K	
	BDS16 25 .. K	BDS68 25 .. K		BDS61 25 .. K	
	BD16 35 .. K	BD68 45 .. K			
	BD16 45 .. K				

C
T
B
Z
TT
BS
IT

pag.
KT029

X FIAM

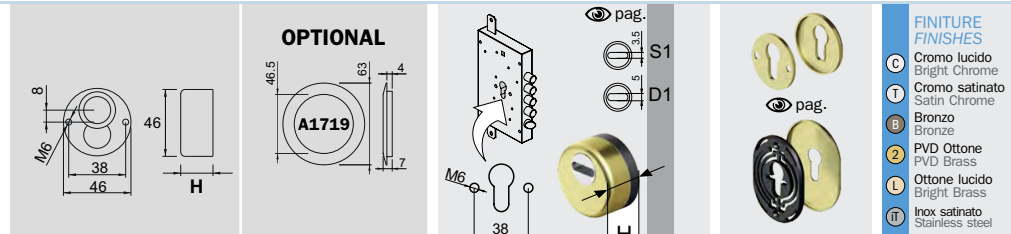
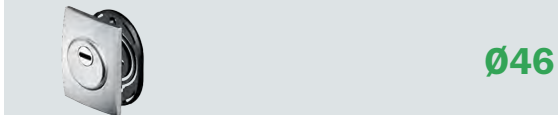
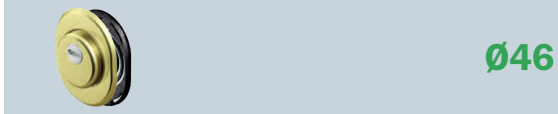
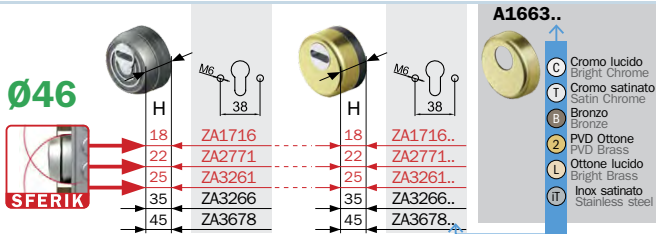

BDS57	18	..	P	..
BDS57	22	..	P	..
BDS57	25	..	P	..
BD57	35	..	P	..
BD57	45	..	P	..

BDS57W	18
BDS57W	22
BDS57W	25
BD57W	35
BD57W	45

BDS57K	18
BDS57K	22
BDS57K	25
BD57K	35
BD57K	45

FINITURE FINISHES

- C Cromo lucido Bright Chrome
- T Cromo satinato Satin Chrome
- B Bronzo Bronze
- 2 PVD Ottone PVD Brass
- L Ottone lucido Bright Brass
- IT Inox satinato Stainless steel

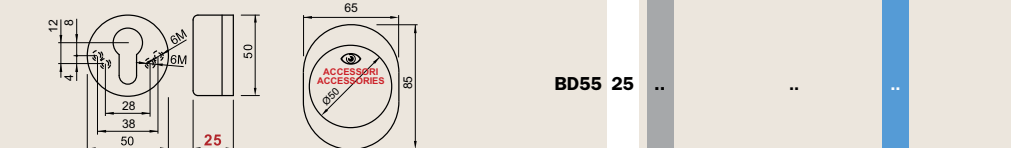

X FIAM

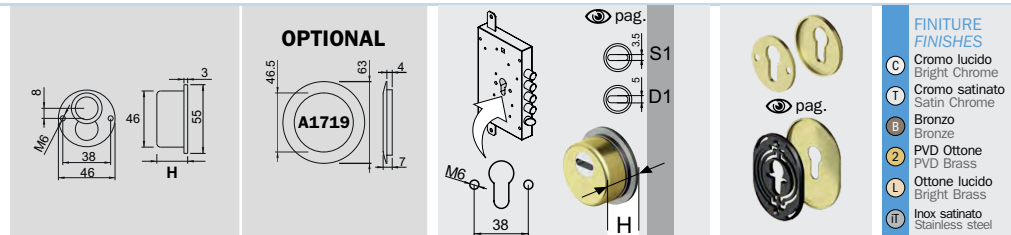
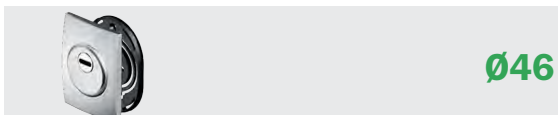
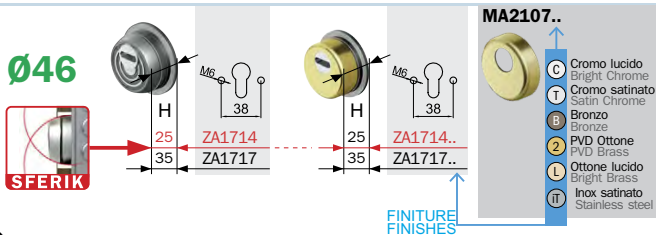
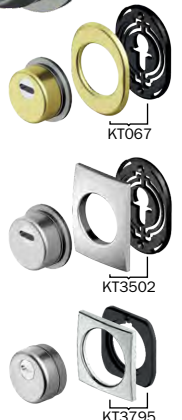

BDS80	25	..	P	..
BD81	35	..	P	..

BDS80W	25
BD81W	35

BDS80K	25
BD81K	35

FINITURE FINISHES

- C Cromo lucido Bright Chrome
- T Cromo satinato Satin Chrome
- B Bronzo Bronze
- 2 PVD Ottone PVD Brass
- L Ottone lucido Bright Brass
- IT Inox satinato Stainless steel



Ø42

SFERIK



KT086

Finish	X ATRA	X CR & ESEY	X ESEY
A0397..	18	22	25
	ZA2166	ZA2254	ZA2490
	31	30.2	21
	30.5	30.5	30.5

FINITURE FINISHES

Finish	X ATRA	X CR & ESEY	X ESEY
A0397..	18	22	25
	ZA2166..	ZA2254..	ZA2490..
	31	30.2	21
	30.5	30.5	30.5

FINITURE FINISHES



Ø42

BDS74 25 ..

BD35 18 ..

BD87 22 ..

FINITURE FINISHES

- C Cromo lucido
- T Bright Chrome
- T Cromo satinato
- T Satin Chrome
- B Bronzo
- B PVD Ottonne
- 2 PVD Brass
- 2 Ottonne satinato
- TT Satin Brass
- BS Bronzo satinato
- BS Satin Bronze
- IT Inox satinato
- IT Stainless Steel

FINITURE FINISHES

- C Cromo lucido
- T Bright Chrome
- T Cromo satinato
- T Satin Chrome
- B Bronzo
- B PVD Ottonne
- 2 PVD Brass
- 2 Ottonne satinato
- TT Satin Brass
- BS Bronzo satinato
- BS Satin Bronze
- IT Inox satinato
- IT Stainless Steel

Kit KT500 (X BDS35..P)



BDS35..P

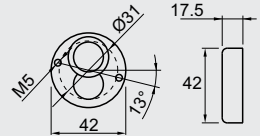

Ø31
M5
17.5
42
13°

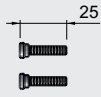

A0412-5025
TOT. 2 PZ



A1063 1mm
A1056 2mm



A1063
TOT. 3 PZ



A1056
TOT. 6 PZ

VITI/SCREW OPTIONAL



L=16 A0412
L=25 A0412-5025
L=70 A0412-5070
L=100 A0412-50100



Ø42

X CR



KT086

Finish	X CR
1	18
2	18
	ZA1598
	30.2

FINITURE FINISHES

Finish	X CR
1	18
2	18
	ZA1598..
	30.2

FINITURE FINISHES



Ø42

BD96 ..

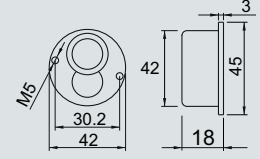

M5
30.2
42
18
3
45

FINITURE FINISHES

- C Cromo lucido
- T Bright Chrome
- T Cromo satinato
- T Satin Chrome
- B Bronzo
- B PVD Ottonne
- 2 PVD Brass
- 2 Ottonne satinato
- TT Satin Brass
- BS Bronzo satinato
- BS Satin Bronze
- IT Inox satinato
- IT Stainless Steel



ZA2365 H 20

A2209..

pag. S1
D1

Ø50

FINITURE FINISHES

- C Cromo lucido Bright Chrome
- T Cromo satinato Satin Chrome
- B Bronzo Bronze
- Z PVD Ottonne PVD Brass
- IT Inox satinato Stainless steel

A3292

56

54

BD28Q 20

KT002

A3293

70

54

BD28C 20

KT029

A3295

54

BD28F 20

KT029

8

46

38

50

20

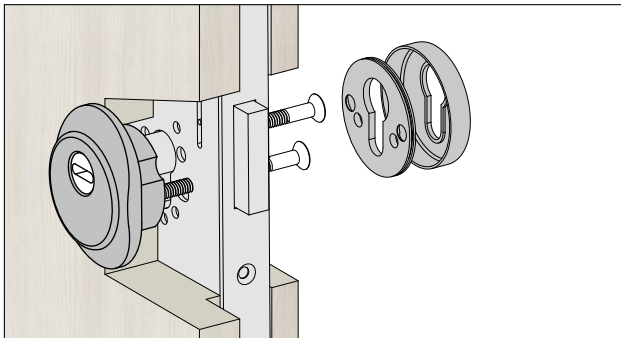

FINITURE FINISHES

- C Cromo lucido Bright Chrome
- T Cromo satinato Satin Chrome
- B Bronzo Bronze
- Z PVD Ottonne PVD Brass
- IT Inox satinato Stainless steel

	S1	D1	C Cromo lucido Bright Chrome	T Cromo satinato Satin Chrome	B Bronzo Bronze
X VIGHI	2	IT	2	IT	BS
VD15					
	50	35	65	Ø50	ACCESSORI ACCESSORIES
X VIGHI	2	IT	2	IT	BS
VD20A					
	50	26	65	Ø50	ACCESSORI ACCESSORIES
X VIGHI	2	IT	2	IT	BS
VD14					
	47.5	25.5	65	Ø50	ACCESSORI ACCESSORIES
X POTENT	2	IT	2	IT	BS
BD8932					
	47.5	25.5	65	Ø48	ACCESSORI ACCESSORIES
X POTENT	2	IT	2	IT	BS
BD89					
	47.5	25.5	65	Ø48	ACCESSORI ACCESSORIES
X ESETY Multilock	2	IT	2	IT	BS
ZA2040					
	25	13	28	42	Ø42
	Per / For				
X ESETY Multilock	2	IT	2	IT	BS
BD92					
	28	13	42.5	65	Ø40
	BD36....				

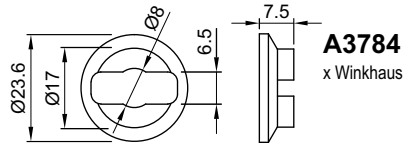
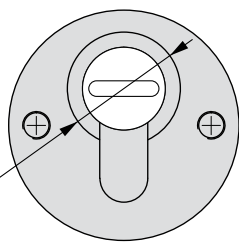

A3784
x Winkhaus

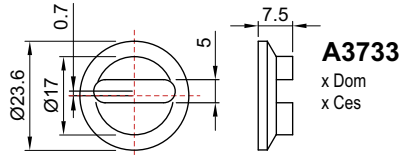

A3733
x Dom
x Ces

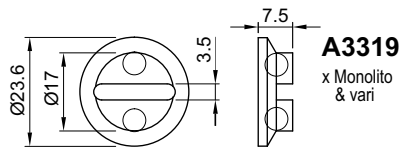

A3319
x Monolito
& vari

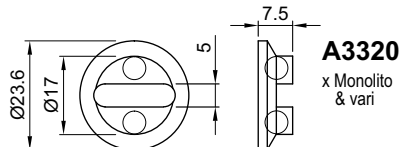

A3320
x Monolito
& vari

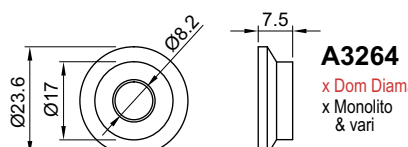

A3264
x Dom Diamant
x Monolito
& vari

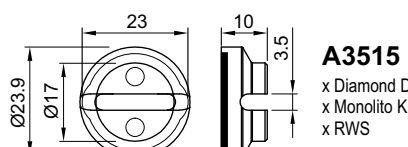

A3515
x Diamond Disec
x Monolito Krypton
x RWS

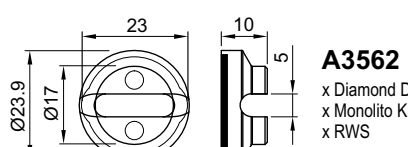

A3562
x Diamond Disec
x Monolito Krypton
x RWS

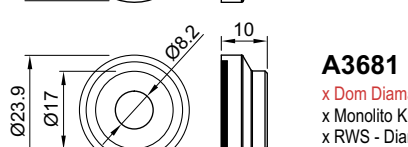

A3681
x Dom Diamant
x Monolito Krypton
x RWS - Diamond

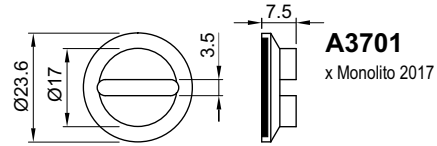

A3701
x Monolito 2017

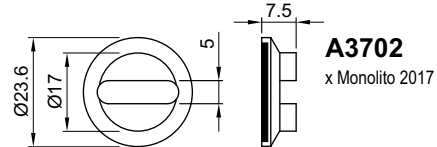

A3702
x Monolito 2017

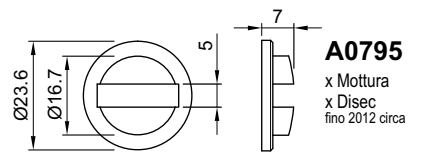

A0795
x Mottura
x Disec
fino 2012 circa

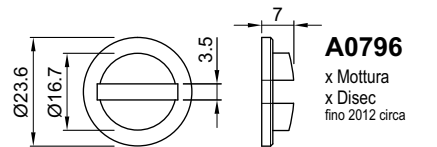

A0796
x Mottura
x Disec
fino 2012 circa

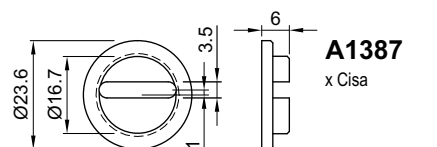

A1387
x Cisa

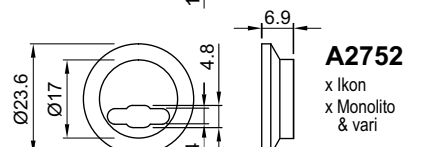

A2752
x Ikon
x Monolito
& vari

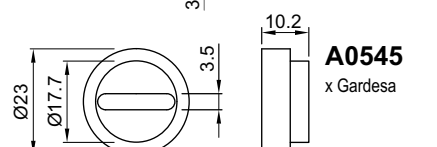

A0545
x Gardesa

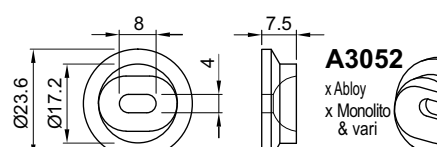

A3052
x Abloy
x Monolito
& vari

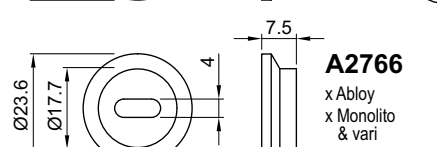

A2766
x Abloy
x Monolito
& vari

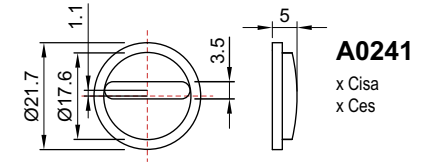
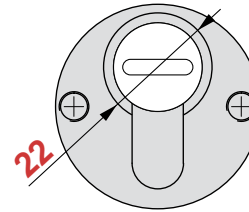

A0241
x Cisa
x Ces

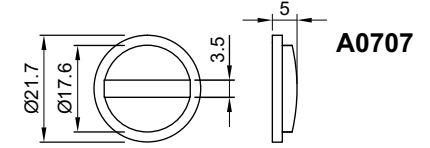

A0707

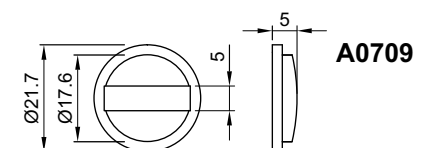

A0709

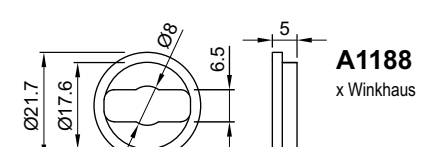

A1188
x Winkhaus

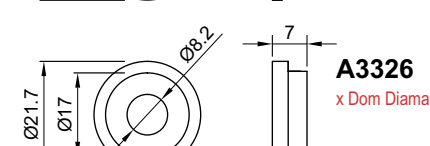

A3326
x Dom Diamant

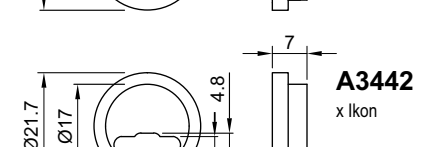

A3442
x Ikon

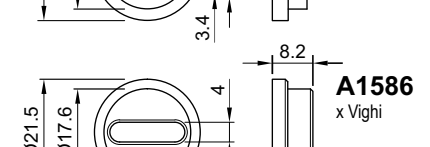

A1586
x Vighi

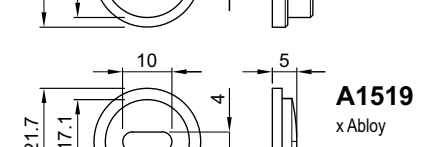

A1519
x Abloy

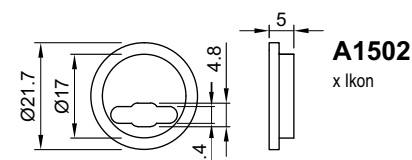

A1502
x Ikon

MAG4G

PAT. PEND.



KMOP47

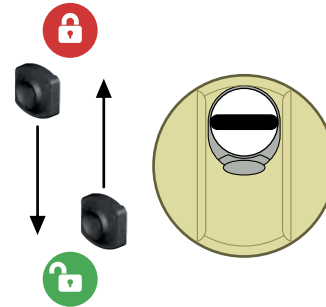
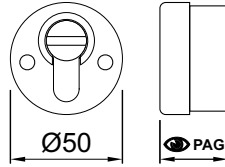
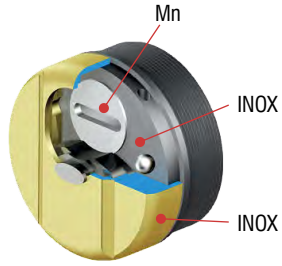

MAG3G

PAT. PEND.



KMOP3G

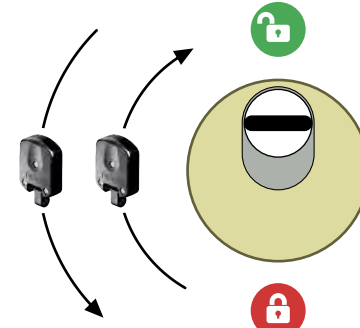
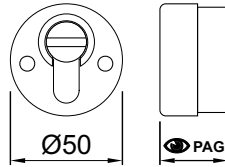
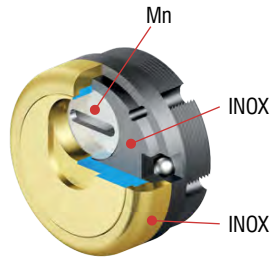

MRM23

PAT. PEND.



KMOP46

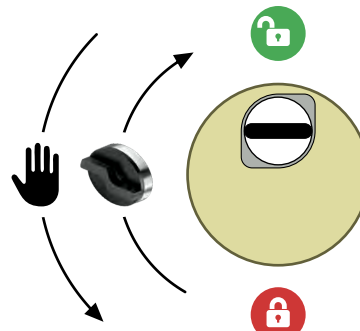
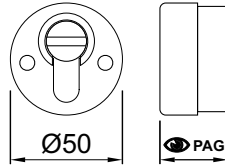
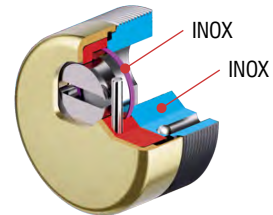
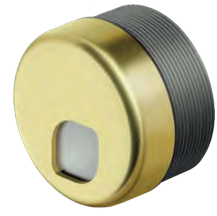

MAG ROUND

PAT. PEND.



KMOP42

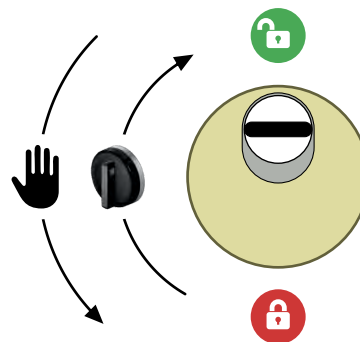
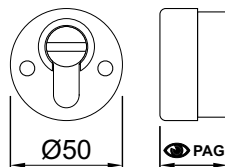
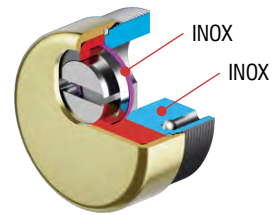
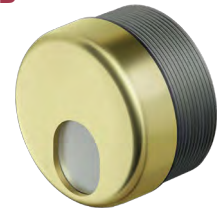

SUPER TOP
86x66



TOP
88x68

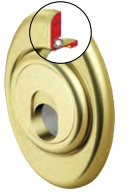

MONOLITO
88x68

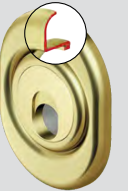

MILANO
Ø 65

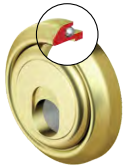

MONOLITO E
Ø 65



QUADRA
65x65



QUADRY
84x64



FILETTATO
Ø50

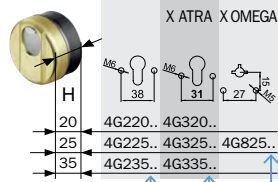

FINITURE FINISHES
C Cromo lucido Bright Chrome
T Cromo satinato Satin Chrome
2 PVD Ottone PVD Brass
IT Inox satinato Stainless steel

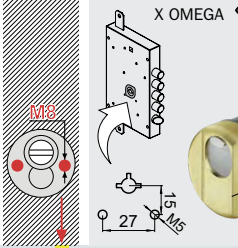
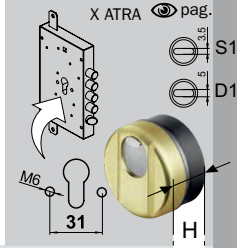
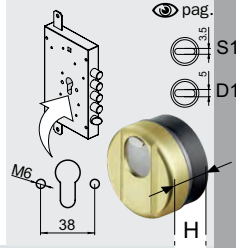

SUPER TOP
56x66

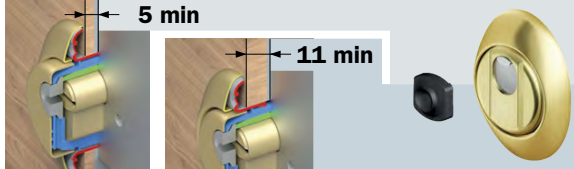

4G2STB 20 ..
4G2STB 25 ..
4G2STB 35 ..

4G3STB 20 ..
4G3STB 25 ..
4G3STB 35 ..

4G2STB 8 20..
ESEMPIO CODICE

4G8STB 25 O1 ..

TOP
88x68

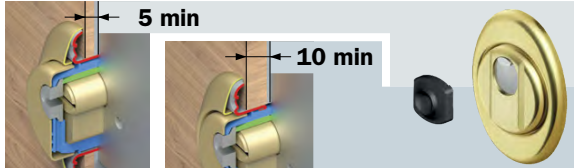

4G2TB 20 ..
4G2TB 25 ..
4G2TB 35 ..

4G3TB 20 ..
4G3TB 25 ..
4G3TB 35 ..

4G8TB 25 O1 ..

4G8TB 25 O1 ..

MONOLITO
88x68

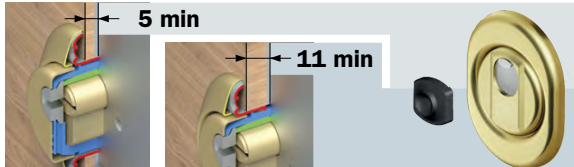
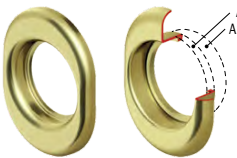

4G2MB 20 ..
4G2MB 25 ..
4G2MB 35 ..

4G3MB 20 ..
4G3MB 25 ..
4G3MB 35 ..

4G8MB 25 O1 ..

4G8MB 25 O1 ..

MILANO
Ø 65

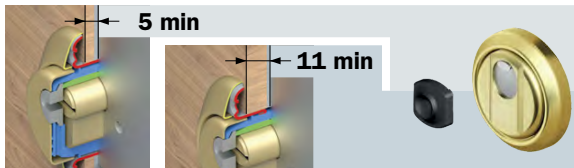

4G2MMB 20 ..
4G2MMB 25 ..
4G2MMB 35 ..

4G3MMB 20 ..
4G3MMB 25 ..
4G3MMB 35 ..

4G8MMB 25 O1 ..

4G8MMB 25 O1 ..

MONOLITO E
Ø 65

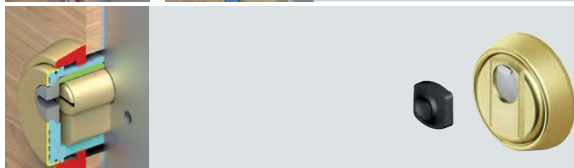

4G2EB 20 ..
4G2EB 25 ..
4G2EB 35 ..

4G3EB 20 ..
4G3EB 25 ..
4G3EB 35 ..

4G8EB 25 O1 ..

4G8EB 25 O1 ..

QUADRA
65x65

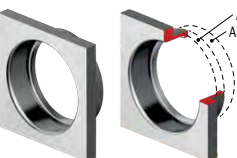

4G2QB 20 ..
4G2QB 25 ..
4G2QB 35 ..

4G3QB 20 ..
4G3QB 25 ..
4G3QB 35 ..

4G8QB 25 O1 ..

4G8QB 25 O1 ..

QUADRY
84x64

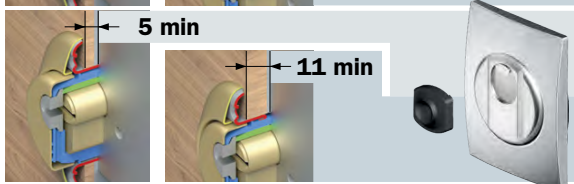
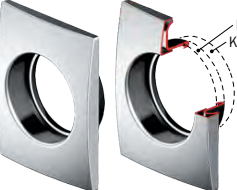

4G2WB 20 ..
4G2WB 25 ..
4G2WB 35 ..

4G3WB 20 ..
4G3WB 25 ..
4G3WB 35 ..

4G8WB 25 O1 ..

4G8WB 25 O1 ..

4G2W 20 ..
4G2W 25 ..
4G2W 35 ..

4G3W 20 ..
4G3W 25 ..
4G3W 35 ..

4G8W 25 O1 ..

4G8W 25 O1 ..

ESEMPIO DI CODICE PER VITI M8

ESEMPIO DI CODICE PER VITI M8

FILETTATO
Ø50

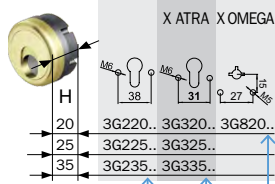

- FINITURE FINISHES
- C Cromo lucido Bright Chrome
 - T Cromo satinato Satin Chrome
 - 2 PVD Ottone PVD Brass
 - IT Inox satinato Stainless steel

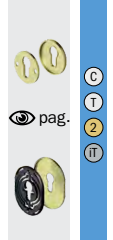
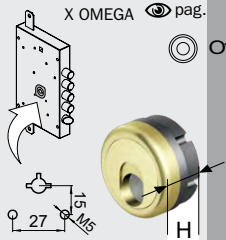
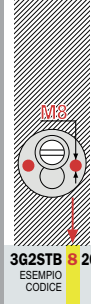
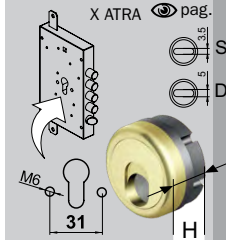
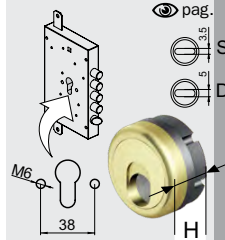

- SUPER TOP 56x66
KT2896 h7
KT2897 h11
- TOP 88x68
KT2002 h5
KT2001 h9
- MONOLITO 88x68
A2082 h5
A1559 h11
- MILANO Ø 65
A1612 h5
A1936 h11
- MONOLITO E Ø 65
A2199
- QUADRA 65x65
A3171 h5
A3060 h11
- QUADRY 84x64
KT3481 h5
KT3482 h11

5 min 11 min

3G25TB 20	..	3G35TB 20	..	3G85TB 20	O1	..
3G25TB 25	..	3G35TB 25	..	3G85TB 25	O1	..
3G25TB 35	..	3G35TB 35	..	3G85TB 35	O1	..
3G25T 20	..	3G35T 20	..	3G85T 20	O1	..
3G25T 25	..	3G35T 25	..	3G85T 25	O1	..
3G25T 35	..	3G35T 35	..	3G85T 35	O1	..
3G25M 20	..	3G35M 20	..	3G85M 20	O1	..
3G25M 25	..	3G35M 25	..	3G85M 25	O1	..
3G25M 35	..	3G35M 35	..	3G85M 35	O1	..
3G25MM 20	..	3G35MM 20	..	3G85MM 20	O1	..
3G25MM 25	..	3G35MM 25	..	3G85MM 25	O1	..
3G25MM 35	..	3G35MM 35	..	3G85MM 35	O1	..
3G25EB 20	..	3G35EB 20	..	3G85EB 20	O1	..
3G25EB 25	..	3G35EB 25	..	3G85EB 25	O1	..
3G25EB 35	..	3G35EB 35	..	3G85EB 35	O1	..
3G25QB 20	..	3G35QB 20	..	3G85QB 20	O1	..
3G25QB 25	..	3G35QB 25	..	3G85QB 25	O1	..
3G25QB 35	..	3G35QB 35	..	3G85QB 35	O1	..
3G25Q 20	..	3G35Q 20	..	3G85Q 20	O1	..
3G25Q 25	..	3G35Q 25	..	3G85Q 25	O1	..
3G25Q 35	..	3G35Q 35	..	3G85Q 35	O1	..
3G25WB 20	..	3G35WB 20	..	3G85WB 20	O1	..
3G25WB 25	..	3G35WB 25	..	3G85WB 25	O1	..
3G25WB 35	..	3G35WB 35	..	3G85WB 35	O1	..
3G25W 20	..	3G35W 20	..	3G85W 20	O1	..
3G25W 25	..	3G35W 25	..	3G85W 25	O1	..
3G25W 35	..	3G35W 35	..	3G85W 35	O1	..

ESEMPIO DI CODICE PER VITI M8

ESEMPIO DI CODICE PER VITI M8

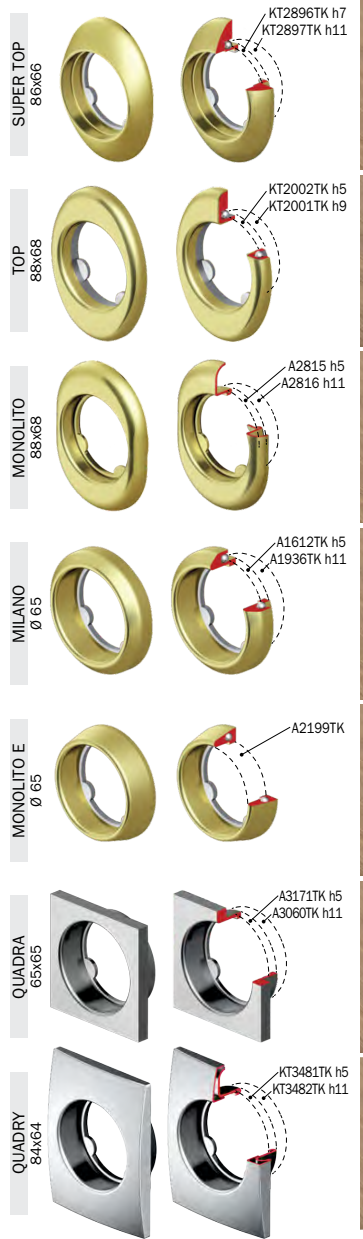
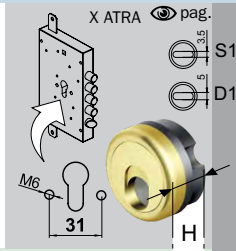
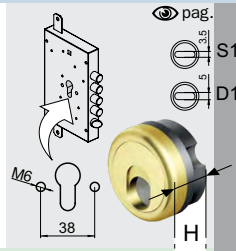
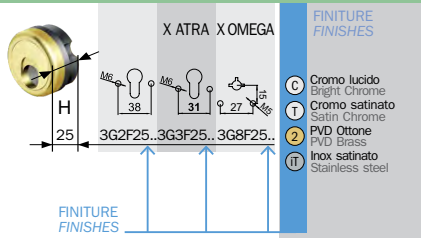
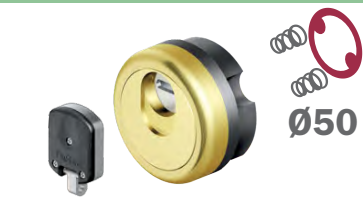

Model	Top	Min	Max	Series	Material	Finish	Accessories
SUPER TOP 56x66	7 min	11 min	25	3G2STBF	25	..	3G3STBF 25 .. 3G8STBF 25 O1 ..
			25	3G2STF	25	..	3G3STF 25 .. 3G8STF 25 O1 ..
TOP 88x68	5 min	9 min	25	3G2TBF	25	..	3G3TBF 25 .. 3G8TBF 25 O1 ..
			25	3G2TF	25	..	3G3TF 25 .. 3G8TF 25 O1 ..
MONOLITO 88x68	5 min	11 min	25	3G2MBF	25	..	3G3MBF 25 .. 3G8MBF 25 O1 ..
			25	3G2MF	25	..	3G3MF 25 .. 3G8MF 25 O1 ..
MILANO Ø 65	5 min	11 min	25	3G2MMBF	25	..	3G3MMBF 25 .. 3G8MMBF 25 O1 ..
			25	3G2MMF	25	..	3G3MMF 25 .. 3G8MMF 25 O1 ..
MONOLITO E Ø 65			25	3G2EBF	25	..	3G3EBF 25 .. 3G8EBF 25 O1 ..
			25	3G2QBF	25	..	3G3QBF 25 .. 3G8QBF 25 O1 ..
QUADRA 65x65	5 min	11 min	25	3G2QBF	25	..	3G3QBF 25 .. 3G8QBF 25 O1 ..
			25	3G2QF	25	..	3G3QF 25 .. 3G8QF 25 O1 ..
QUADRY 84x64	5 min	11 min	25	3G2WBF	25	..	3G3WBF 25 .. 3G8WBF 25 O1 ..
			25	3G2WF	25	..	3G3WF 25 .. 3G8WF 25 O1 ..

MAG 4G

4G



Ø50

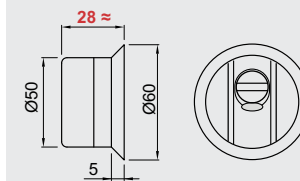
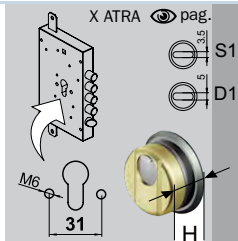
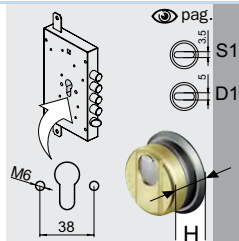
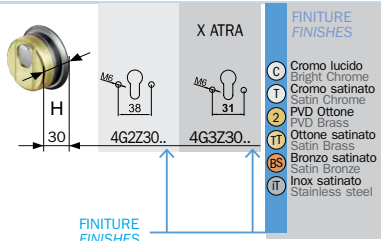

- FINITURE FINISHES
- C Cromo lucido
 - T Bright Chrome
 - 2 Cromo satinato
 - BS Satin Chrome
 - IT PVD Ottono
 - 2 PVD Brass
 - BS Ottono satinato
 - IT Satin Brass
 - BS Bronzo satinato
 - IT Satin Bronze
 - IT Inox satinato
 - IT Stainless steel

	4G2Z 30 .. P	4G3Z 30 .. P	<p>4G2Z 8 20.. ESEMPIO CODICE</p> <p>ESEMPIO DI CODICE PER VITI M8 EXAMPLE OF CODE FOR FIXING M8</p>	<p>pag.</p>
	4G2ZW 30 .. P	4G3ZW 30 .. P		
	4G2ZK 30 .. P	4G3ZK 30 .. P		

- pag.
- C Cromo lucido
 - T Bright Chrome
 - 2 Cromo satinato
 - BS Satin Chrome
 - IT PVD Ottono
 - 2 PVD Brass
 - BS Ottono satinato
 - IT Satin Brass
 - BS Bronzo satinato
 - IT Satin Bronze
 - IT Inox satinato
 - IT Stainless steel

MAG 3G

3G



Ø50

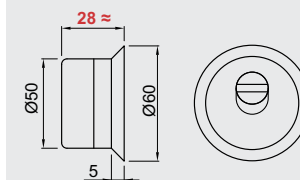
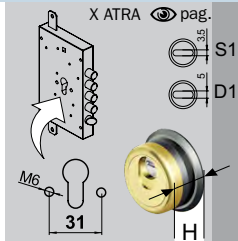
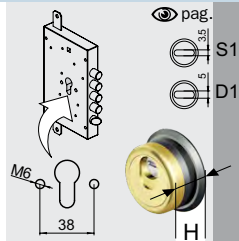
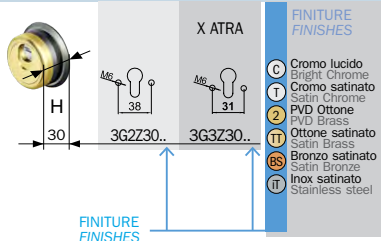

- FINITURE FINISHES
- C Cromo lucido
 - T Bright Chrome
 - 2 Cromo satinato
 - BS Satin Chrome
 - IT PVD Ottono
 - 2 PVD Brass
 - BS Ottono satinato
 - IT Satin Brass
 - BS Bronzo satinato
 - IT Satin Bronze
 - IT Inox satinato
 - IT Stainless steel

	3G2Z 30 .. P	3G3Z 30 .. P	<p>3G2Z 8 20 ESEMPIO CODICE</p> <p>ESEMPIO DI CODICE PER VITI M8 EXAMPLE OF CODE FOR FIXING M8</p>	<p>pag.</p>
	3G2ZW 30 .. P	3G3ZW 30 .. P		
	4G2ZK 30 .. P	4G3ZK 30 .. P		

- pag.
- C Cromo lucido
 - T Bright Chrome
 - 2 Cromo satinato
 - BS Satin Chrome
 - IT PVD Ottono
 - 2 PVD Brass
 - BS Ottono satinato
 - IT Satin Brass
 - BS Bronzo satinato
 - IT Satin Bronze
 - IT Inox satinato
 - IT Stainless steel

FILETTATO
Ø50

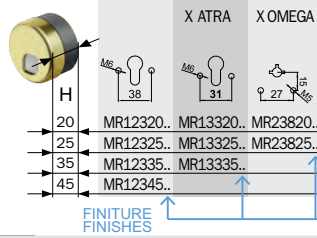

- FINITURE FINISHES**
- C Cromo lucido / Bright Chrome
 - T Cromo satinato / Satin Chrome
 - B Bronzo / Bronze
 - Z PVD Ottone / PVD Brass
 - TI Ottone satinato / Satin Brass
 - BS Bronzo satinato / Satin Bronze
 - IT Inox satinato / Stainless steel

SUPER TOP
56x66

TOP
88x68

MONOLITO
88x68

MILANO
Ø 65

MONOLITO E
Ø 65

QUADRA
65x65

QUADRY
84x64

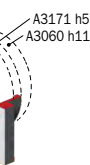
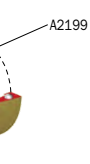
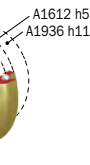
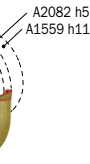
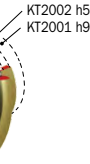

	7 min		11 min	
	5 min		9 min	
	5 min		11 min	
	5 min		11 min	
	5 min		11 min	
	5 min		11 min	

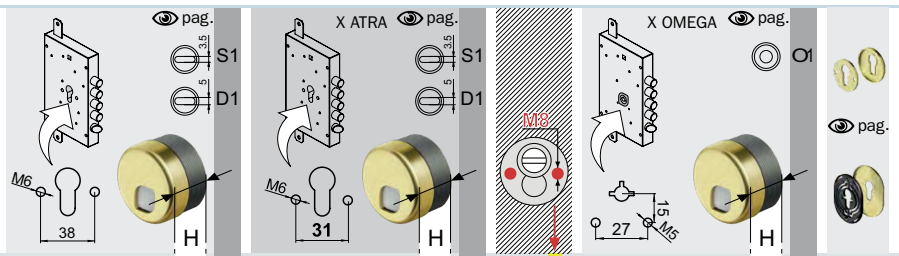

MRSTB23 20	MRSTB33 20	MRSTB23 8 20..	MRSTB103 20
MRSTB23 25	MRSTB33 25		MRSTB103 25
MRSTB23 35	MRSTB33 35		
MRSTB23 45			
MRSTA23 20	MRSTA33 20		MRSTA103 20
MRSTA23 25	MRSTA33 25		MRSTA103 25
MRSTA23 35	MRSTA33 35		
MRSTA23 45			
MRTB23 20	MRTB33 20		MRTB103 20
MRTB23 25	MRTB33 25		MRTB103 25
MRTB23 35	MRTB33 35		
MRTB23 45			
MRTA23 20	MRTA33 20		MRTA103 20
MRTA23 25	MRTA33 25		MRTA103 25
MRTA23 35	MRTA33 35		
MRTA23 45			
MRM23B 20	MRM33B 20		MRM103B 20
MRM23B 25	MRM33B 25		MRM103B 25
MRM23B 35	MRM33B 35		
MRM23B 45			
MRM23 20	MRM33 20		MRM103A 20
MRM23 25	MRM33 25		MRM103A 25
MRM23 35	MRM33 35		
MRM23 45			
MRM23MB 20	MRM33MB 20		MRM103MB 20
MRM23MB 25	MRM33MB 25		MRM103MB 25
MRM23MB 35	MRM33MB 35		
MRM23MB 45			
MRM23MA 20	MRM33MA 20		MRM103MA 20
MRM23MA 25	MRM33MA 25		MRM103MA 25
MRM23MA 35	MRM33MA 35		
MRM23MA 45			
MRME23 20	MRME33 20		MRE103 20
MRME23 25	MRME33 25		MRE103 25
MRME23 35	MRME33 35		
MRME23 45			
MRQA23 20	MRQA33 20		MRQA103 20
MRQA23 25	MRQA33 25		MRQA103 25
MRQA23 35	MRQA33 35		
MRQA23 45			
MRQB23 20	MRQB33 20		MRQB103 20
MRQB23 25	MRQB33 25		MRQB103 25
MRQB23 35	MRQB33 35		
MRQB23 45			
MRWA23 20	MRWA33 20		MRWA103 20
MRWA23 25	MRWA33 25		MRWA103 25
MRWA23 35	MRWA33 35		
MRWA23 45			
MRWB23 20	MRWB33 20		MRWB103 20
MRWB23 25	MRWB33 25		MRWB103 25
MRWB23 35	MRWB33 35		
MRWB23 45			

ESEMPIO DI CODICE PER VITI M8

ESEMPIO DI CODICE PER VITI M8

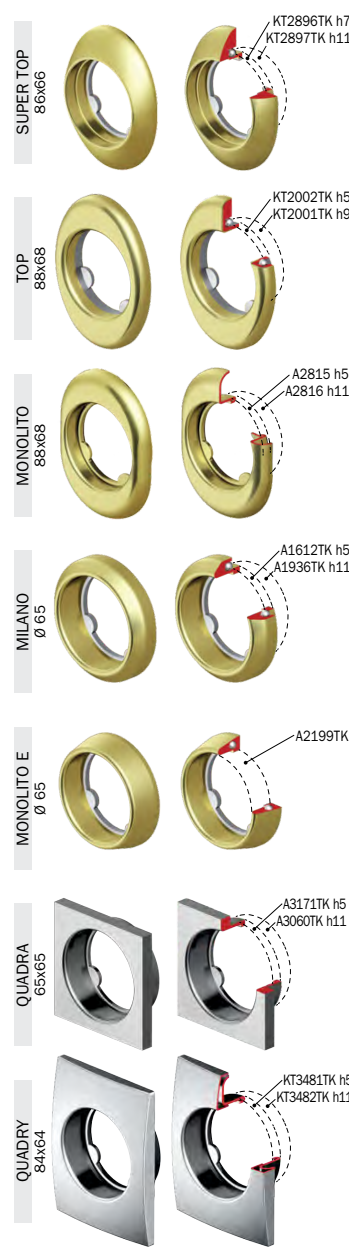
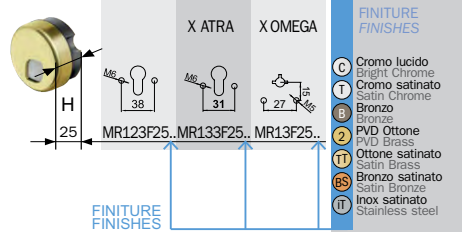

Model	Width	Depth	Mounting	Finish	Series	Material	Color	Accessories
MRSTBF23	25	..	7 min	Wavy	X ATRA	MRSTBF33	25	..
MRSTAF23	25	..	11 min	Wavy	X ATRA	MRSTAF33	25	..
MRTBF23	25	..	5 min	Wavy	X OMEGA	MRTBF13	25	..
MRTAF23	25	..	9 min	Wavy	X OMEGA	MRTAF13	25	..
MRM23BF	25	..	5 min	Wavy	X ATRA	MRM33BF	25	..
MRM23F	25	..	11 min	Wavy	X ATRA	MRM33F	25	..
MRM23MBF	25	..	5 min	Wavy	X OMEGA	MRM33MBF	25	..
MRM23MAF	25	..	11 min	Wavy	X OMEGA	MRM33MAF	25	..
MRME23F	25	..	5 min	Wavy	X ATRA	MRME33F	25	..
MRQAF23	25	..	5 min	Wavy	X OMEGA	MRQAF13	25	..
MRQBF23	25	..	11 min	Wavy	X OMEGA	MRQBF13	25	..
MRWAF23	25	..	5 min	Wavy	X ATRA	MRWAF33	25	..
MRWBF23	25	..	11 min	Wavy	X ATRA	MRWBF33	25	..

MAG ROUND

MR123

FILETTATO Ø50

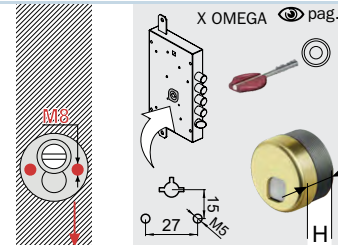
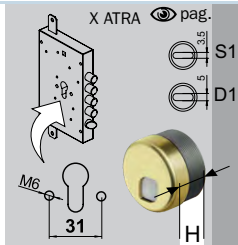
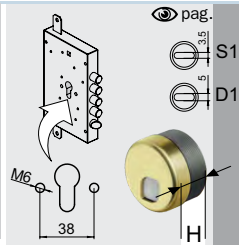
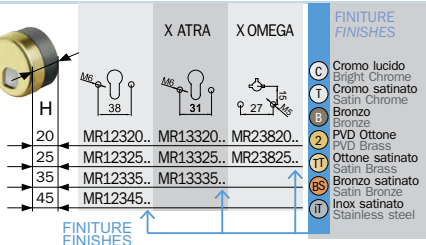

MR123 20	..	P
MR123 25	..	P
MR123 35	..	P
MR123 45	..	P
MRW123 20	..	P
MRW123 25	..	P
MRW123 35	..	P
MRW123 45	..	P
MRK123 20	..	P
MRK123 25	..	P
MRK123 35	..	P
MRK123 45	..	P

MR133 20	..	P
MR133 25	..	P
MR133 35	..	P
MRW133 20	..	P
MRW133 25	..	P
MRW133 35	..	P
MRK133 20	..	P
MRK133 25	..	P
MRK133 35	..	P

MR123 8 20..
ESEMPIO CODICE

ESEMPIO DI CODICE PER VITI M8
EXAMPLE OF CODE FOR FIXING M8

MR103 20	O1	P
MR103 25	O1	P

MR103 20	O1	P
MR103 25	O1	P

pag.

- C Cromo lucido Bright Chrome
- T Cromo satinato Satin Chrome
- B Bronzo Bronze
- 2 PVD Ottonne PVD Brass
- TT Ottonne satinato Satin Brass
- BS Bronzo satinato Satin Bronze
- IT Inox satinato Stainless steel

MRZ - 23 - MAG ROUND

Ø50

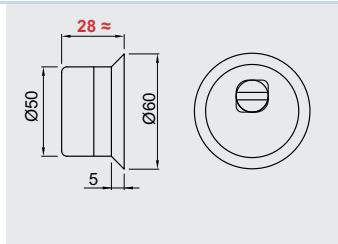
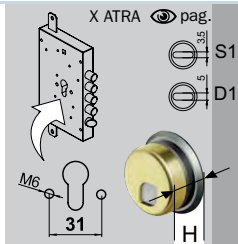
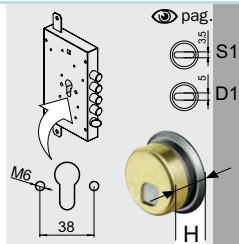
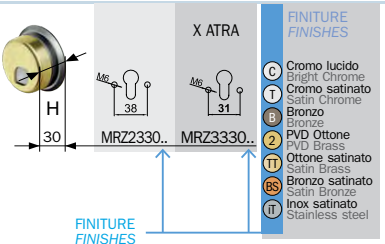

MRZ23 30	..	P
MRZW23 30	..	P
MRZK23 30	..	P

MRZ33 30	..	P
MRZW33 30	..	P
MRZK33 30	..	P

MRZ23 8 20
ESEMPIO CODICE

ESEMPIO DI CODICE PER VITI M8
EXAMPLE OF CODE FOR FIXING M8

MRZ23 30	..	P
----------	----	---

MRZ23 30	..	P
----------	----	---

pag.

- C Cromo lucido Bright Chrome
- T Cromo satinato Satin Chrome
- B Bronzo Bronze
- 2 PVD Ottonne PVD Brass
- IT Inox satinato Stainless steel

FILETTATO
Ø50

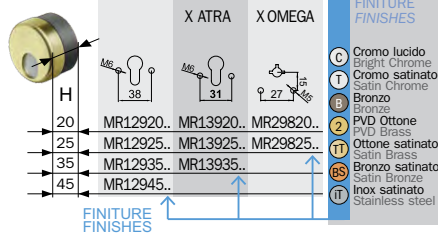

- FINITURE FINISHES
- C Cromo lucido / Bright Chrome
 - T Cromo satinato / Satin Chrome
 - B Bronzo / Bronze
 - Z PVD Ottone / PVD Brass
 - TT Ottone satinato / Satin Brass
 - BS Bronzo satinato / Satin Bronze
 - IT Inox satinato / Stainless steel

SUPER TOP
56x66



KT2896 h7
KT2897 h11

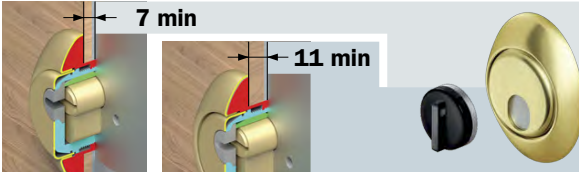

TOP
88x68



KT2002 h5
KT2001 h9

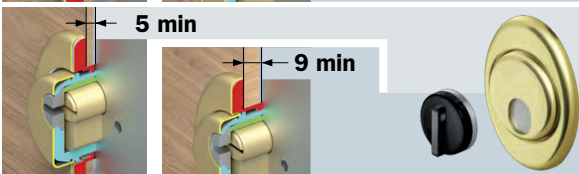

MONOLITO
88x68

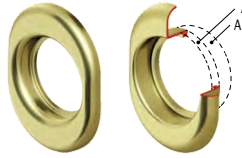

A2082 h5
A1559 h11

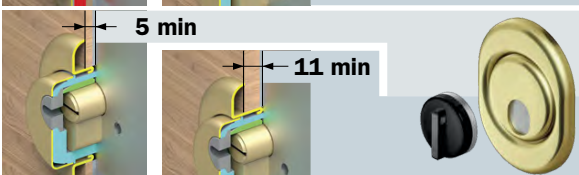

MILANO
Ø 65



A1612 h5
A1936 h11

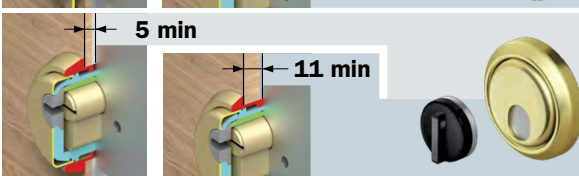

MONOLITO E
Ø 65

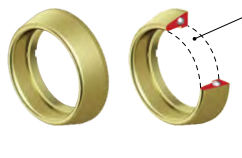

A2199

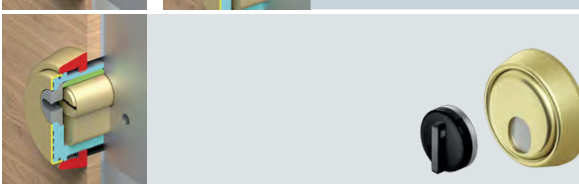

QUADRA
65x65

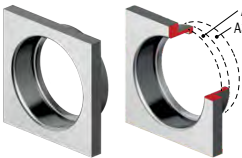

A3171 h5
A3060 h11



QUADRY
84x64

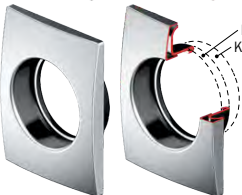

KT3481 h5
KT3482 h11

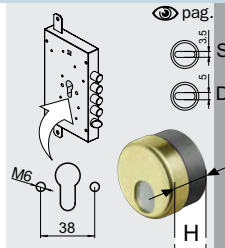
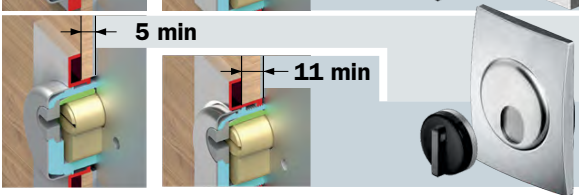

- MRSTB29 20 ..
MRSTB29 25 ..
MRSTB29 35 ..
MRSTB29 45 ..
MRSTA29 20 ..
MRSTA29 25 ..
MRSTA29 35 ..
MRSTA29 45 ..

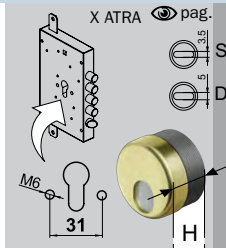

- MRSTB39 20 ..
MRSTB39 25 ..
MRSTB39 35 ..
MRSTA39 20 ..
MRSTA39 25 ..
MRSTA39 35 ..



- MRSTB29 8 20..
ESEMPIO CODICE

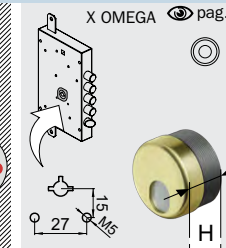

- MRSTB108 20 ..
MRSTB108 25 ..

- MRTB29 20 ..
MRTB29 25 ..
MRTB29 35 ..
MRTB29 45 ..
MRTA29 20 ..
MRTA29 25 ..
MRTA29 35 ..
MRTA29 45 ..

- MRTB39 20 ..
MRTB39 25 ..
MRTB39 35 ..
MRTA39 20 ..
MRTA39 25 ..
MRTA39 35 ..

ESEMPIO DI CODICE FOR FIXING M8

- MRTB108 20 ..
MRTB108 25 ..
MRTA108 20 ..
MRTA108 25 ..

- MRM29B 20 ..
MRM29B 25 ..
MRM29B 35 ..
MRM29B 45 ..
MRM29 20 ..
MRM29 25 ..
MRM29 35 ..
MRM29 45 ..

- MRM39B 20 ..
MRM39B 25 ..
MRM39B 35 ..
MRM39 20 ..
MRM39 25 ..
MRM39 35 ..

ESEMPIO DI CODICE PER VITI M8

- MRM108B 20 ..
MRM108B 25 ..
MRM108A 20 ..
MRM108A 25 ..

- MRM29MB 20 ..
MRM29MB 25 ..
MRM29MB 35 ..
MRM29MB 45 ..
MRM29MA 20 ..
MRM29MA 25 ..
MRM29MA 35 ..
MRM29MA 45 ..

- MRM39MB 20 ..
MRM39MB 25 ..
MRM39MB 35 ..
MRM39MA 20 ..
MRM39MA 25 ..
MRM39MA 35 ..

ESEMPIO DI CODICE PER VITI M8

- MRM108MB 20 ..
MRM108MB 25 ..
MRM108MA 20 ..
MRM108MA 25 ..

- MRM29E 20 ..
MRM29E 25 ..
MRM29E 35 ..
MRM29E 45 ..

- MRM39E 20 ..
MRM39E 25 ..
MRM39E 35 ..

ESEMPIO DI CODICE PER VITI M8

- MRM108E 20 ..
MRM108E 25 ..

- MRQA29 20 ..
MRQA29 25 ..
MRQA29 35 ..
MRQA29 45 ..
MRQB29 20 ..
MRQB29 25 ..
MRQB29 35 ..
MRQB29 45 ..

- MRQA39 20 ..
MRQA39 25 ..
MRQA39 35 ..
MRQB39 20 ..
MRQB39 25 ..
MRQB39 35 ..

ESEMPIO DI CODICE PER VITI M8

- MRQA108 20 ..
MRQA108 25 ..
MRQB108 20 ..
MRQB108 25 ..

- MRWA29 20 ..
MRWA29 25 ..
MRWA29 35 ..
MRWA29 45 ..
MRWB29 20 ..
MRWB29 25 ..
MRWB29 35 ..
MRWB29 45 ..

- MRWA39 20 ..
MRWA39 25 ..
MRWA39 35 ..
MRWB39 20 ..
MRWB39 25 ..
MRWB39 35 ..

ESEMPIO DI CODICE PER VITI M8

- MRWA108 20 ..
MRWA108 25 ..
MRWB108 20 ..
MRWB108 25 ..

MR - 129 - MAG ROUND

FILETTATO Ø50

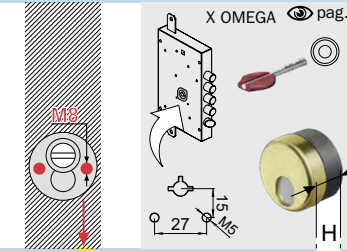
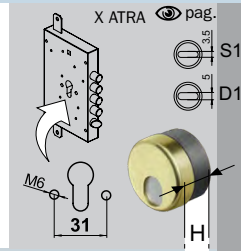
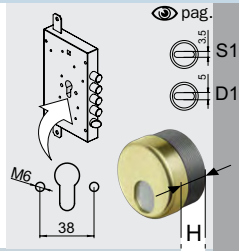
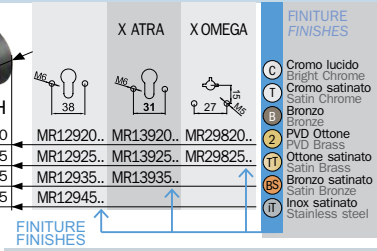

MR129 8 20..
 ESEMPIO DI CODICE PER VITI M8
 EXAMPLE OF CODE FOR FIXING M8

	MRW129 20 .. P	MRW129 25 .. P	MRW129 35 .. P	MRW129 45 .. P
	MRK129 20 .. P	MRK129 25 .. P	MRK129 35 .. P	MRK129 45 .. P

	MRW139 20 .. P	MRW139 25 .. P	MRW139 35 .. P
	MRK139 20 .. P	MRK139 25 .. P	MRK139 35 .. P

	MRW108 20 O1 P	MRW108 25 O1 P
	MRK108 20 O1 P	MRK108 25 O1 P



MRZ - 29 - MAG ROUND

Ø50

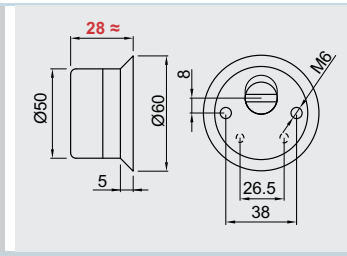
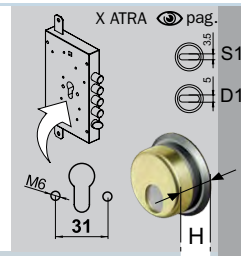
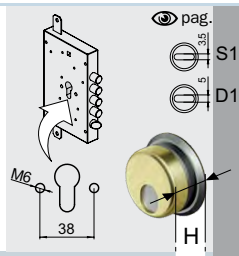
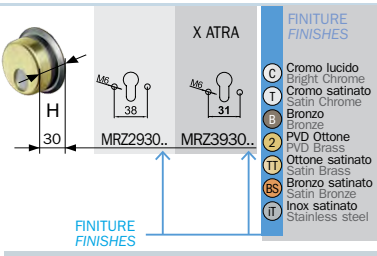

	MRW29 30 .. P
	MRZW29 30 .. P
	MRZK29 30 .. P

	MRW39 30 .. P
	MRZW39 30 .. P
	MRZK39 30 .. P

	MRZ29 8 20 .. P
--	-----------------



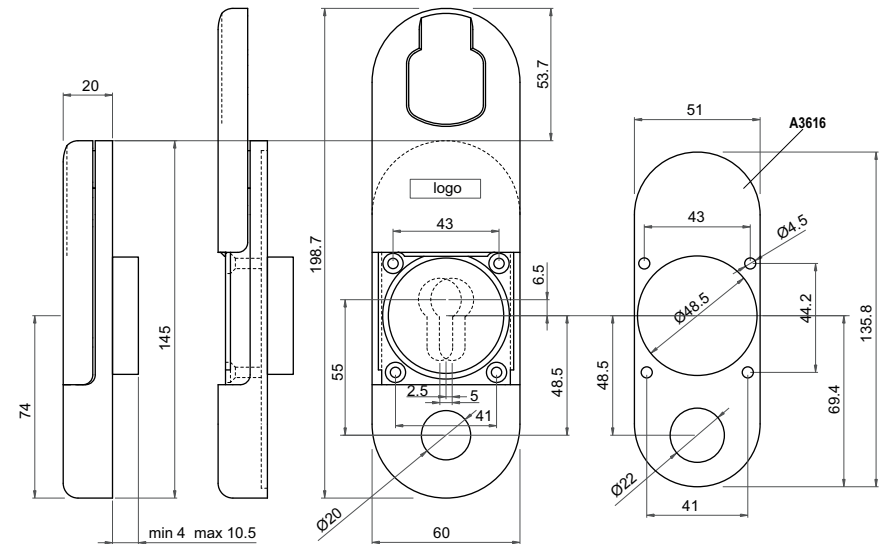
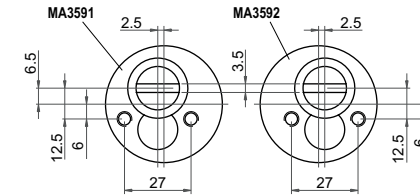
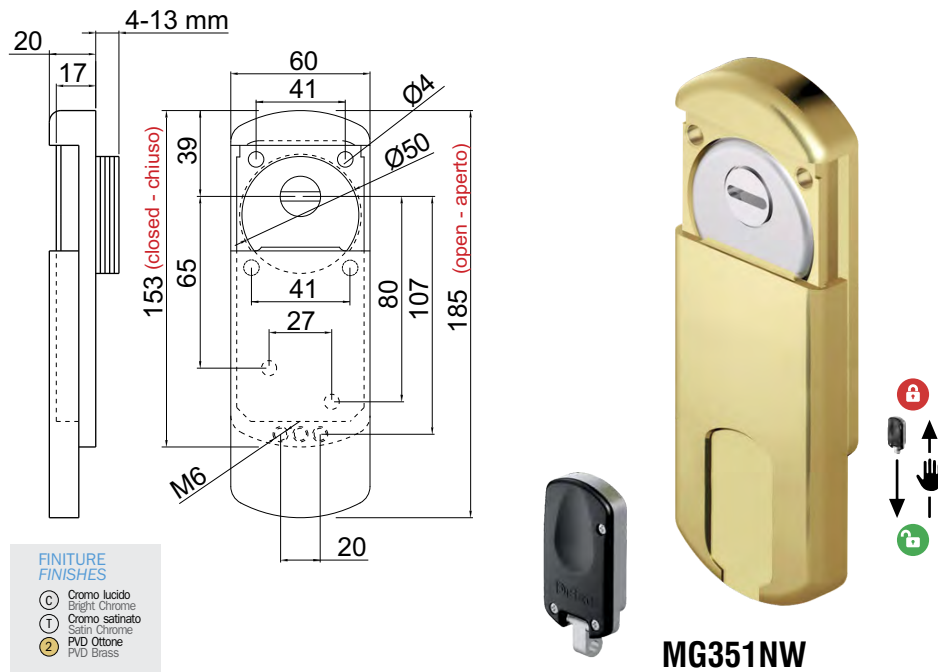
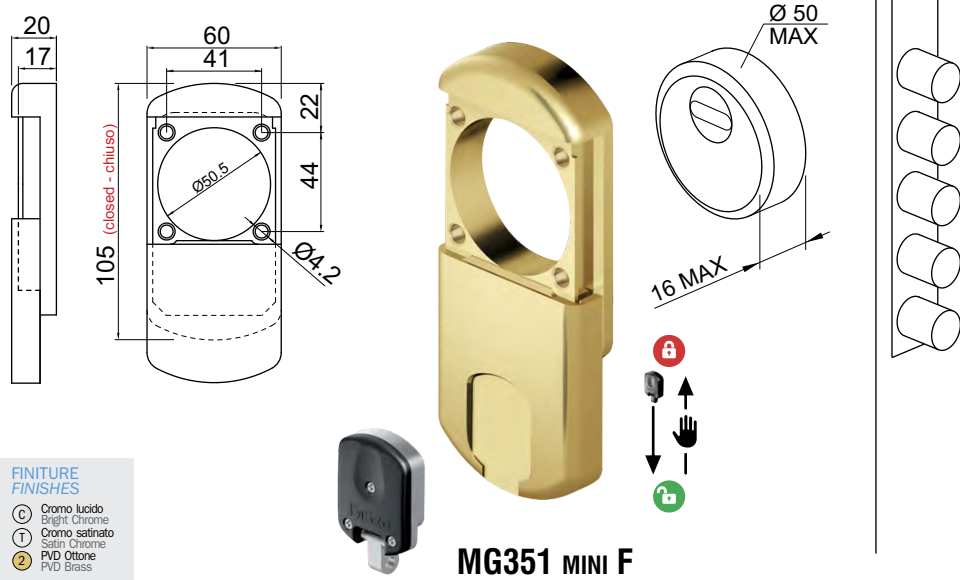

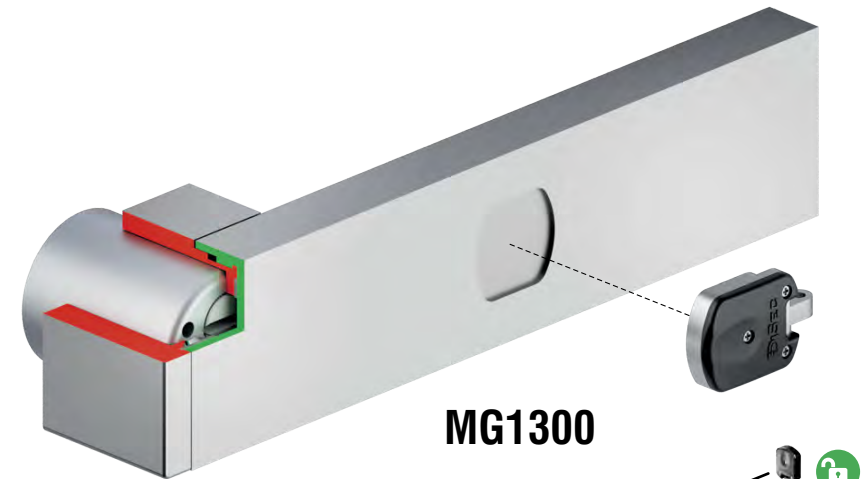
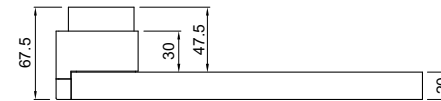
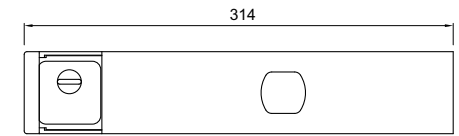
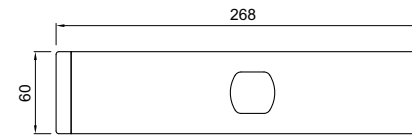

KEY BOX SERVICE KIT



KTXP70 KIT 20 pz **KM0P70**
x MG 351 NEW
x 3W



KTXP42 KIT 20 pz **KM0P42**
x MAG ROUND



KTXP40 KIT 20 pz **KM0P40**
x MAG ROUND 128



KTXP47 KIT 20 pz **KM0P47**
x MAG 4G



KM0019 KIT 20 pz **KM0006**
x 2W



KTXP55 KIT 20 pz **KM0P55**
x MG355



KM0023 KIT 20 pz **KM0027**



KTXP46 KIT 20 pz **KM0P46**
x MAG ROUND



KTXP85 KIT 20 pz **KM0P85**
x 4W



KTXP90 KIT 20 pz **KM0P90**
x 5W



KTXP3G KIT 20 pz **KM0P3G**
x 3W

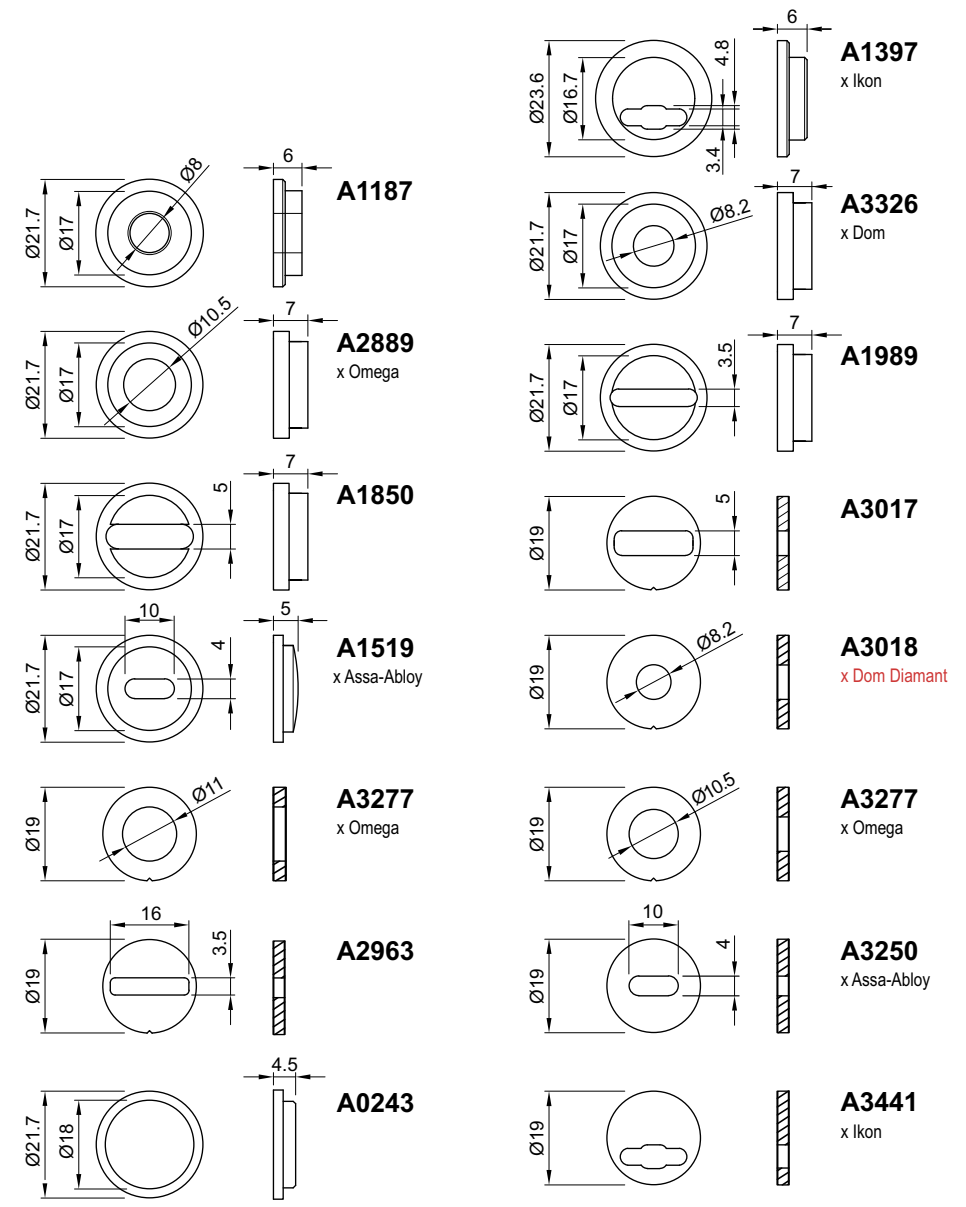
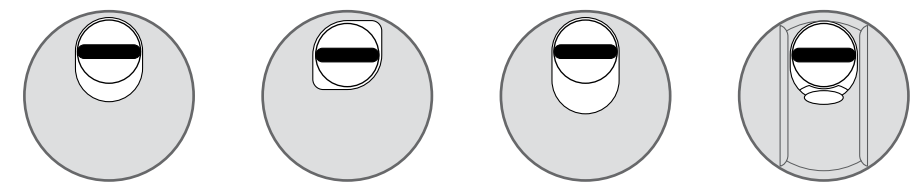

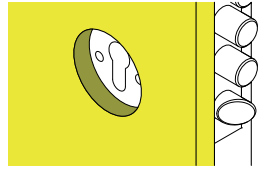
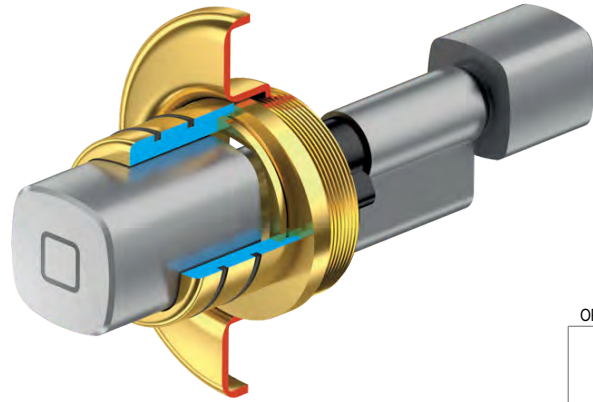

INOX



X KABA
XE510
XE511 X ATRA

OPTIONAL

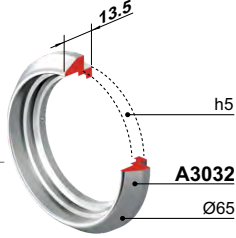

A3032

Ø65

OPTIONAL

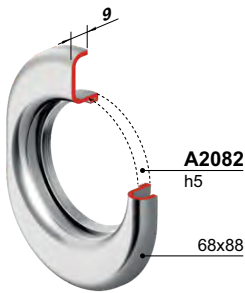

A2082

h5

68x88

OPTIONAL



KT072

68x88

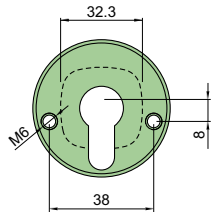
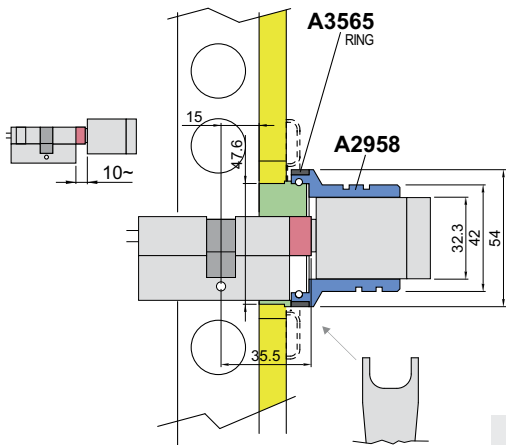

A2957

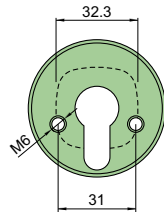

A3676
X ATRA

FINITURE / FINISHES

② Inox PVD gold color IT Inox satin

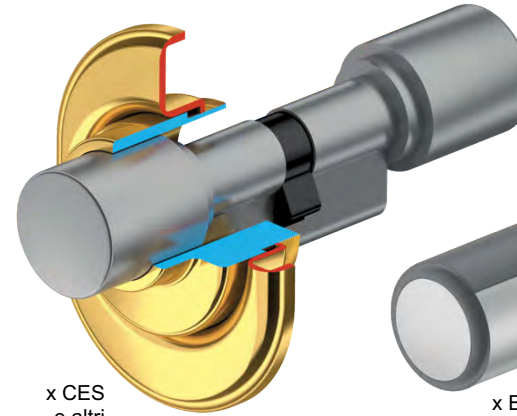

x CES
e altri

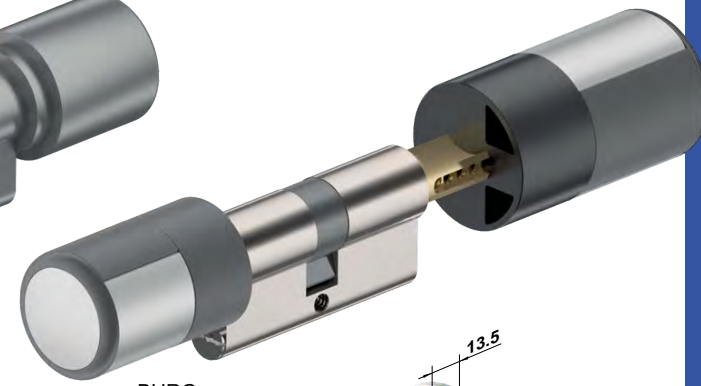

x BURG

INOX



X CES / X BURG
A2658
A3101 X ATRA

OPTIONAL

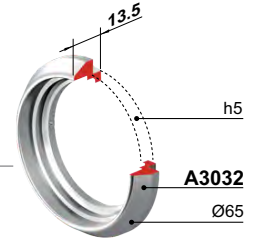

A3032

Ø65

OPTIONAL

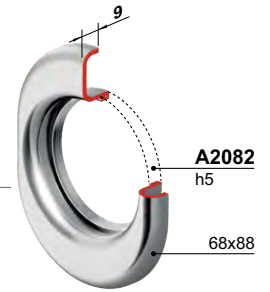

A2082

h5

68x88

OPTIONAL



KT072

68x88

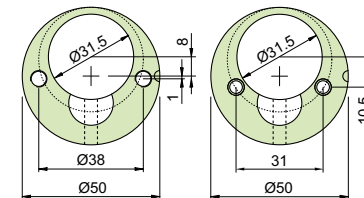
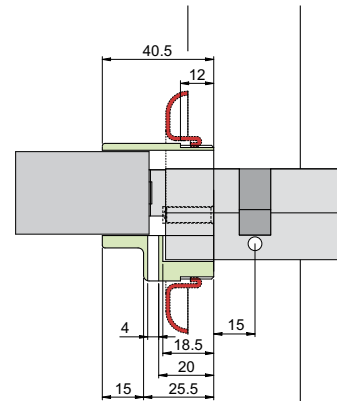

A2658

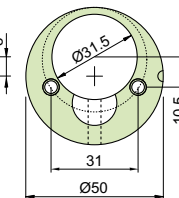

A3101
X ATRA

FINITURE / FINISHES

② Inox PVD gold color
IT Inox satin

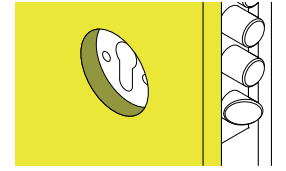
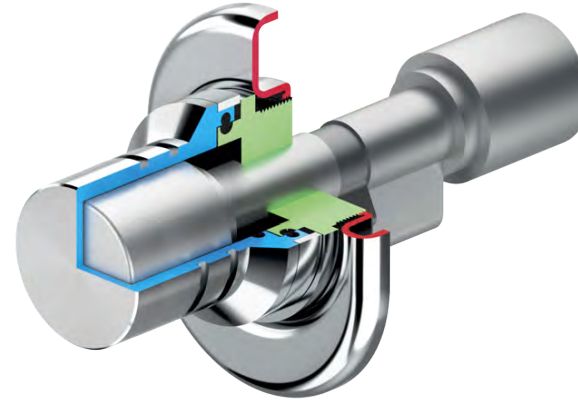
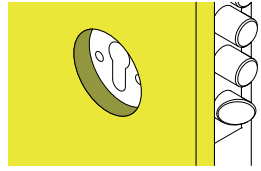
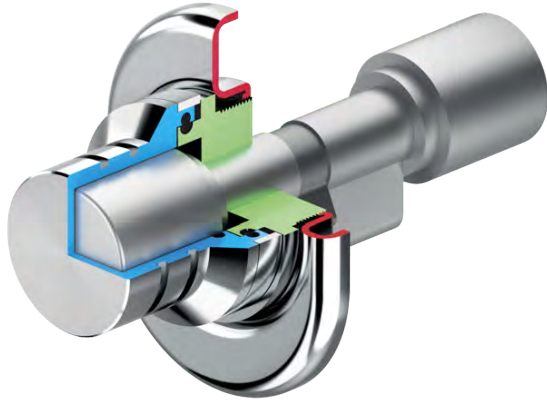

INOX



X SIMONS VOSS
XE601
XE607 X ATRA

OPTIONAL

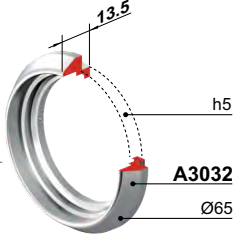

A3032
Ø65

OPTIONAL

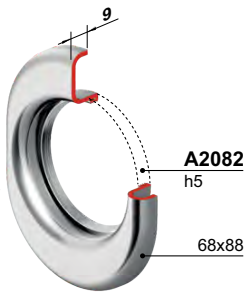

A2082
h5
68x88

OPTIONAL



KT072
68x88

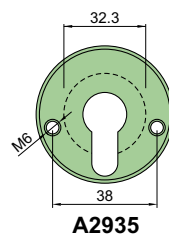
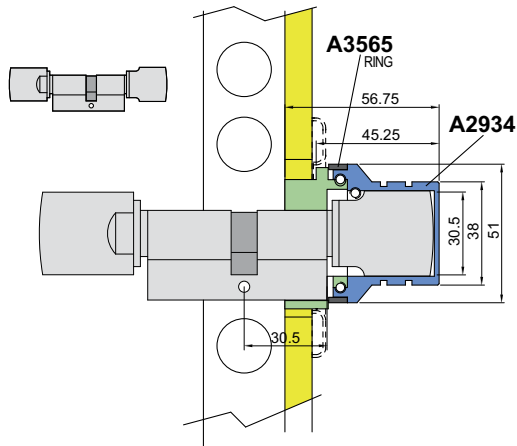

A2935

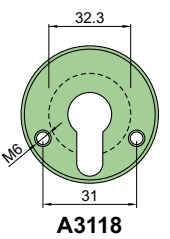

A3118
X ATRA

Sp. 8/10 - A3583
Sp. 20/10 - A3584

FINITURE / FINISHES
② Inox PVD gold color Ⓜ Inox satin

INOX



X SIMONS VOSS
XE609
XE610 X ATRA

OPTIONAL

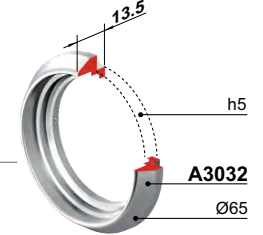

A3032
Ø65

OPTIONAL

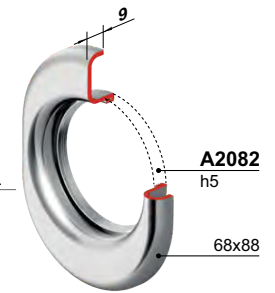

A2082
h5
68x88

OPTIONAL



KT072
68x88

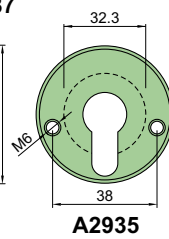
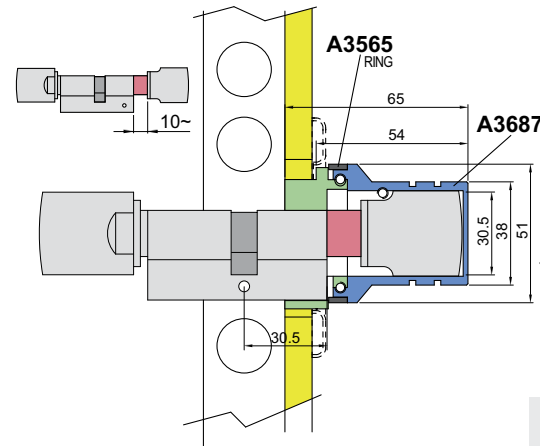

A2935

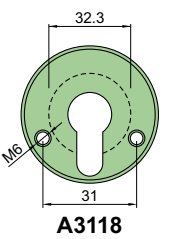

A3118
X ATRA

Sp. 8/10 - A3583
Sp. 20/10 - A3584

FINITURE / FINISHES
② Inox PVD gold color Ⓜ Inox satin

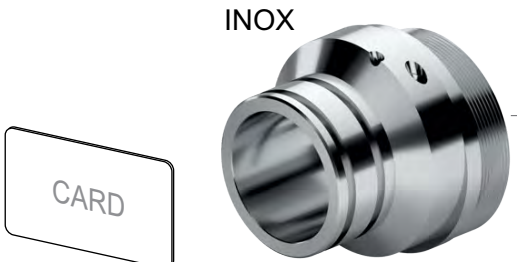
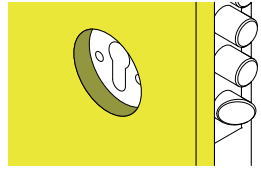
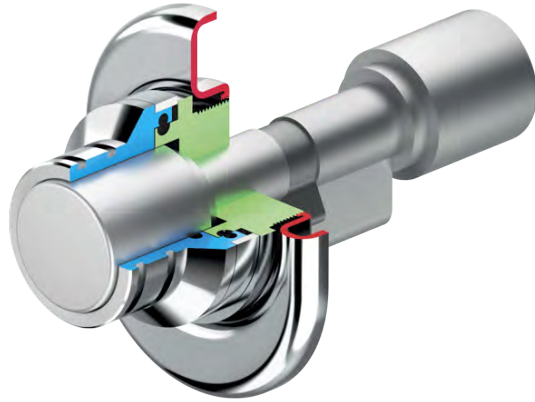

X SIMONS VOSS
XE602
XE608 X ATRA

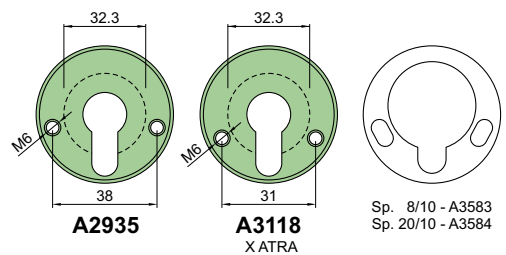
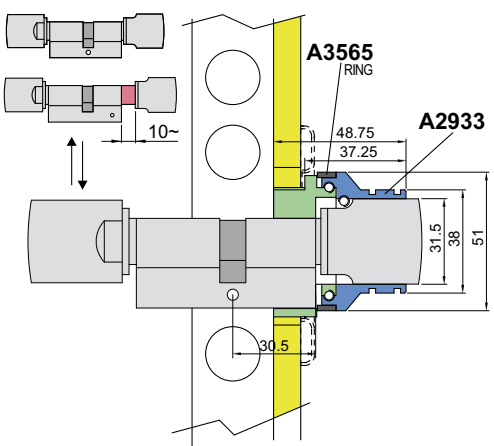
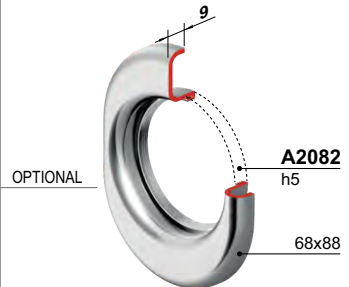
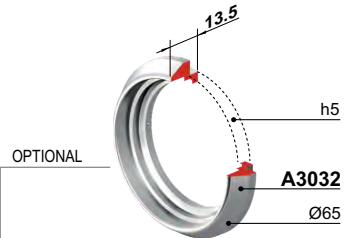

FINITURE / FINISHES
② Inox PVD gold color (IT) Inox satin

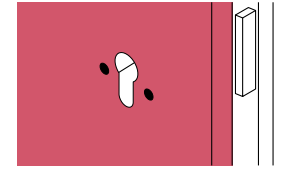
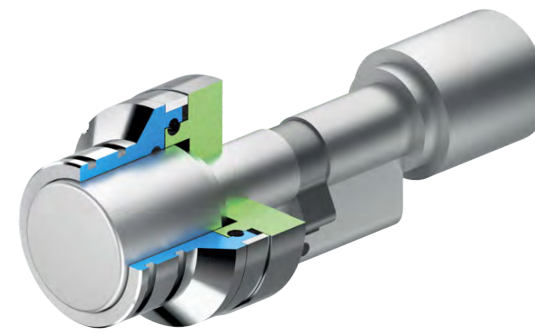

X SIMONS VOSS **XE605**

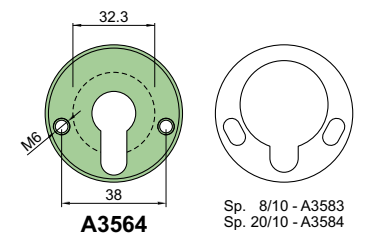
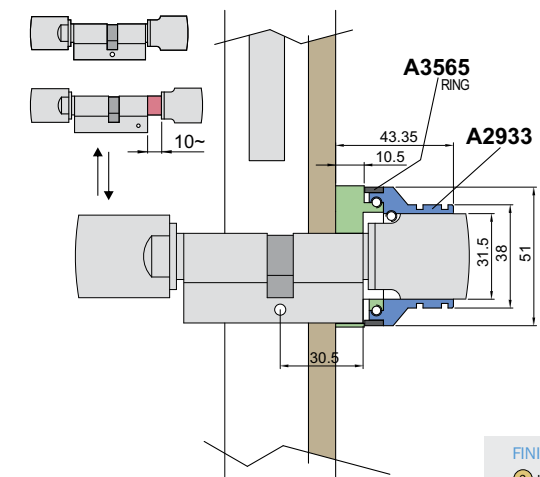

FINITURE / FINISHES
② Inox PVD gold color (IT) Inox satin

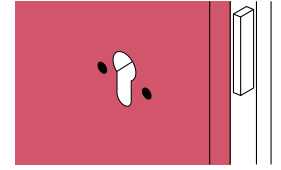
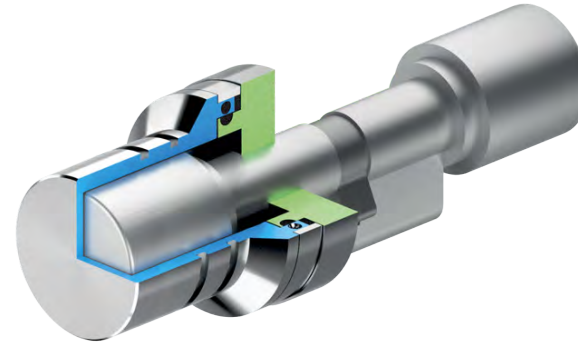
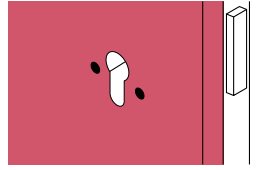
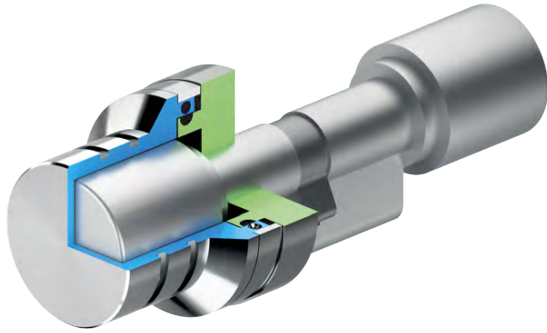

X SIMONS VOSS XE606

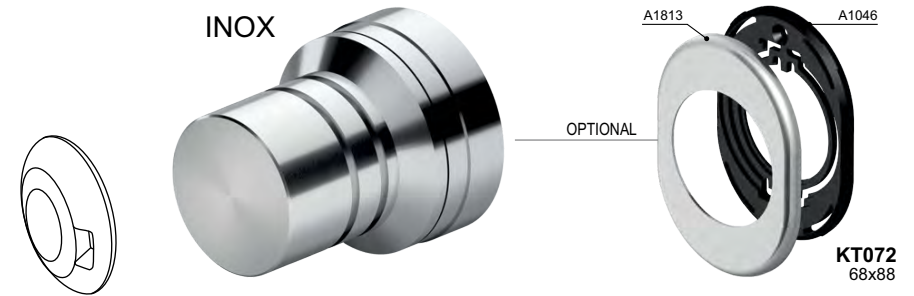

X SIMONS VOSS XE611

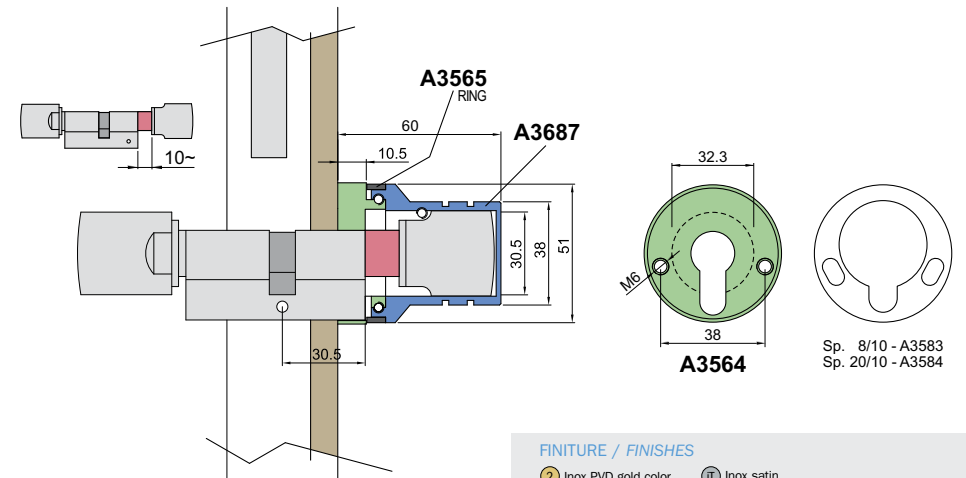
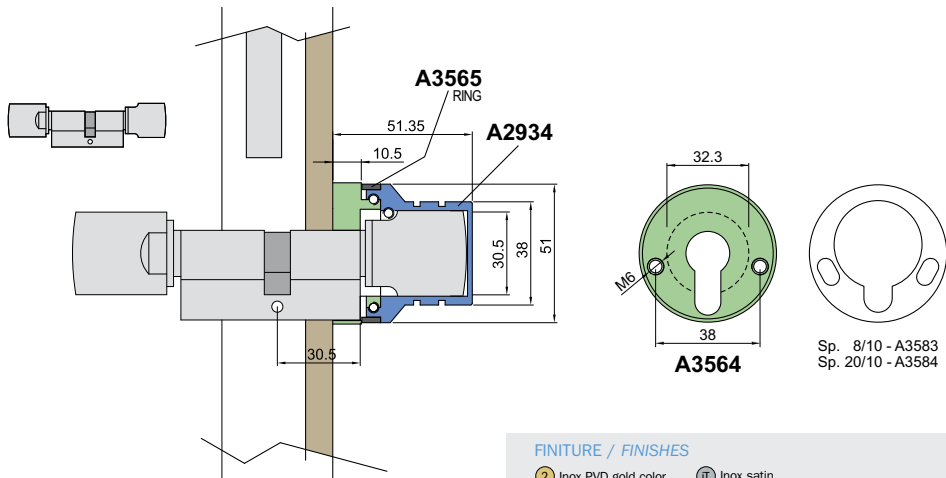

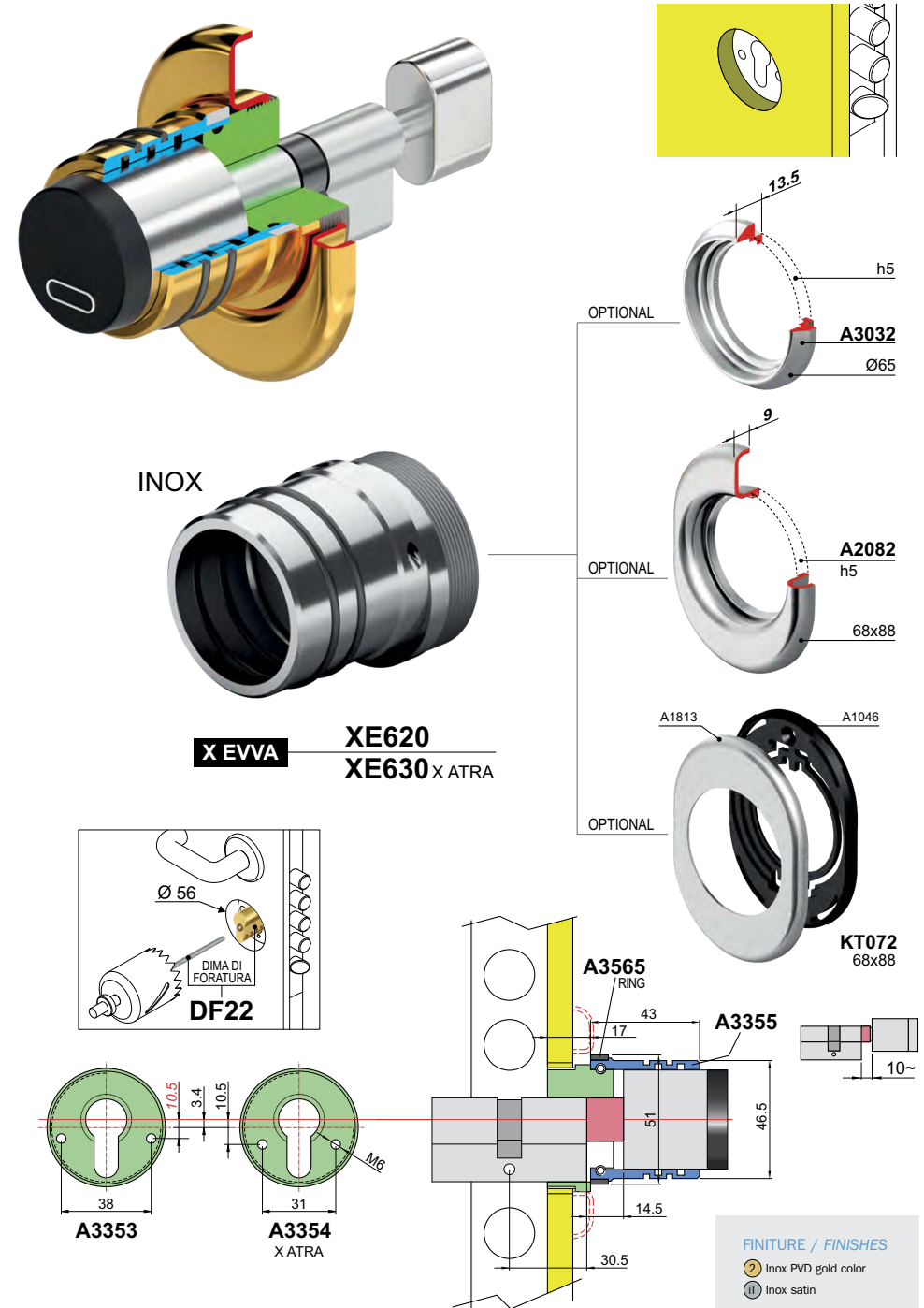
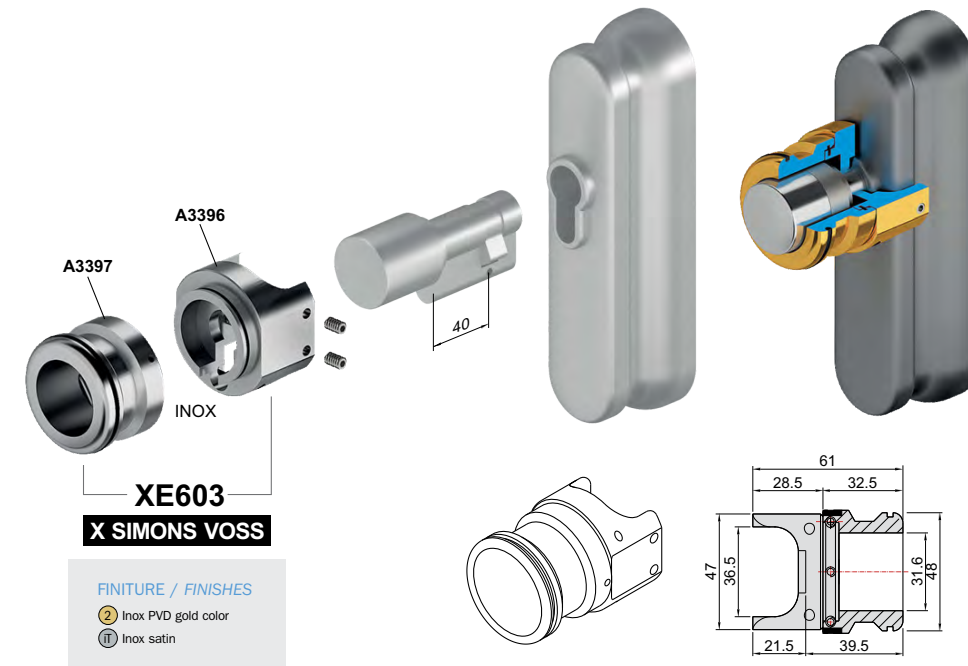
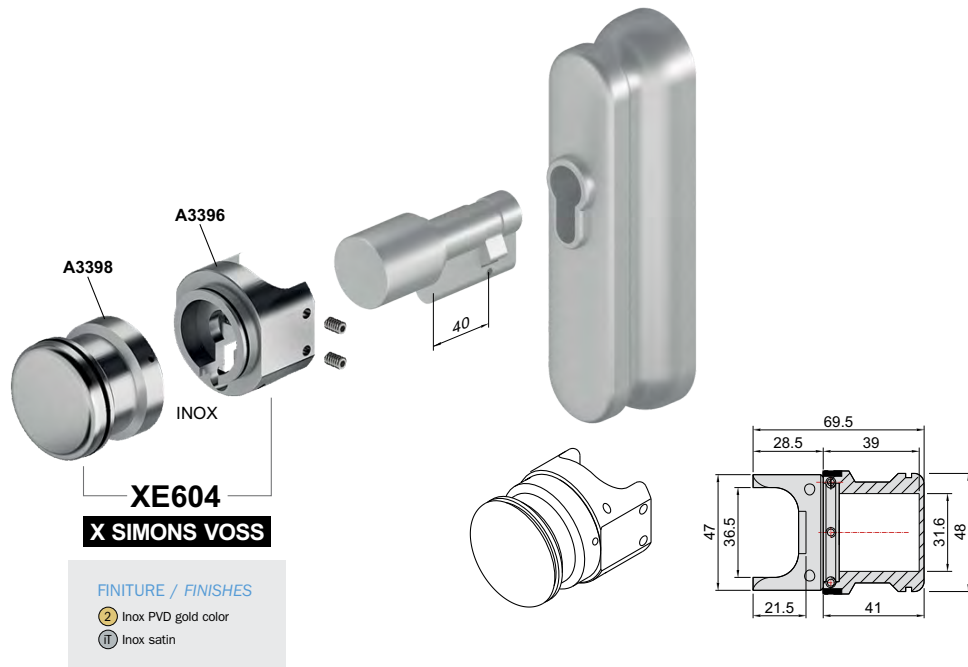

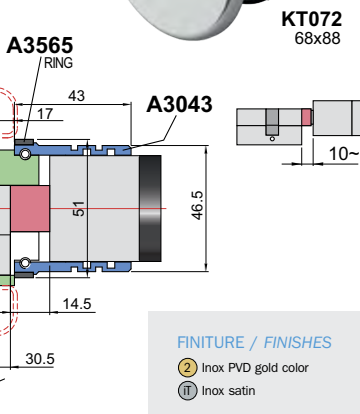
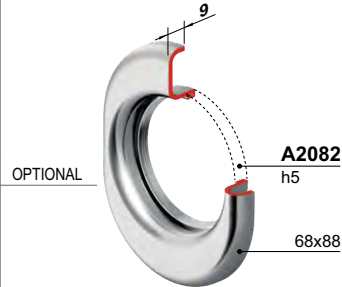
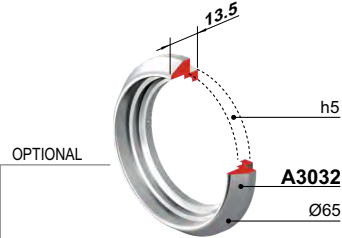
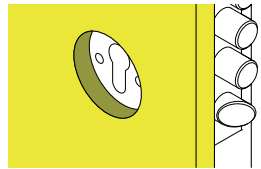
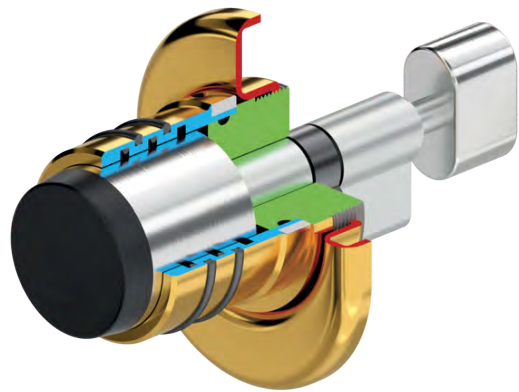

INOX



X SALTO
XE640
XE650 X ATRA

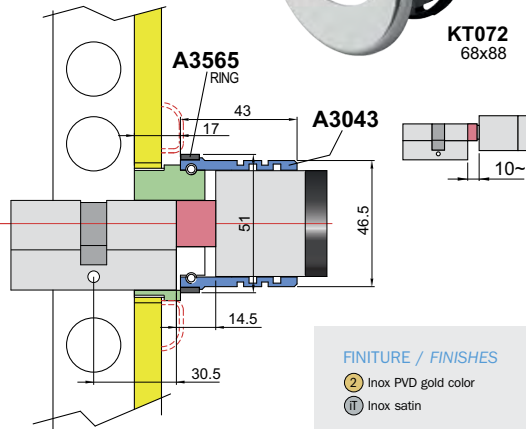
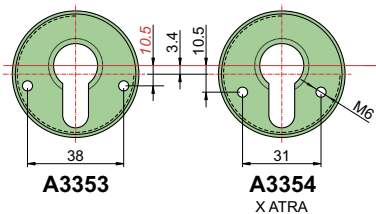
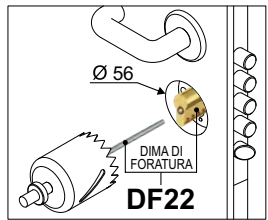

FINITURE / FINISHES

- ② Inox PVD gold color
- Ⓜ Inox satin

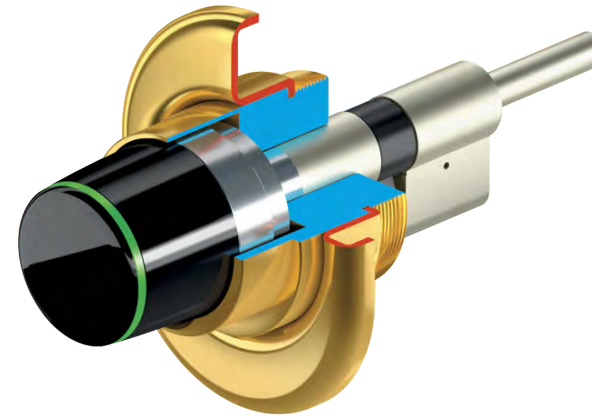

INOX



X ISEO
XE720LB
XE730LB X ATRA

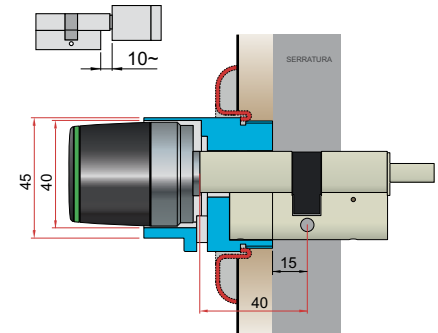
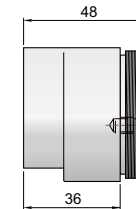
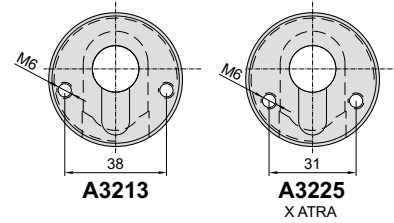
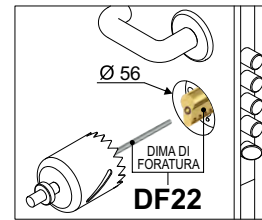
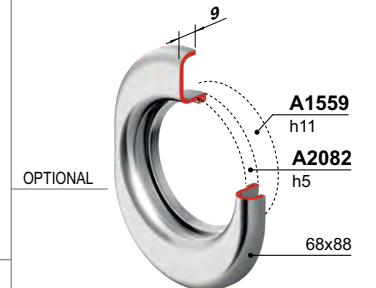
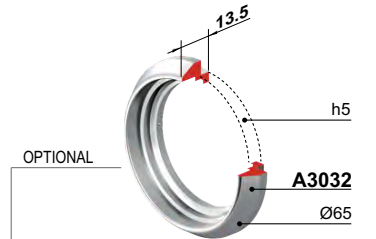

FINITURE / FINISHES

- ② Inox PVD gold color
- Ⓜ Inox satin

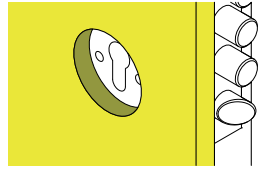
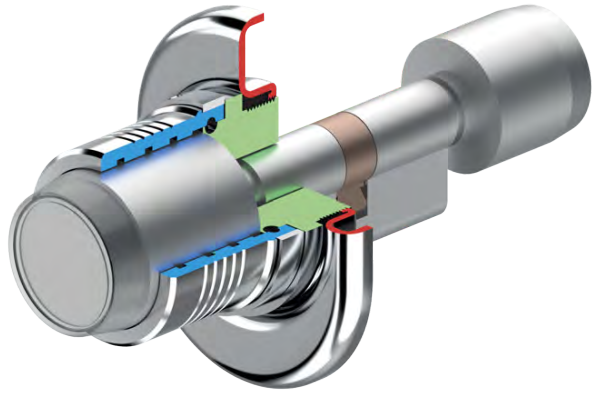

X DOM
XE660
XE670 X ATRA

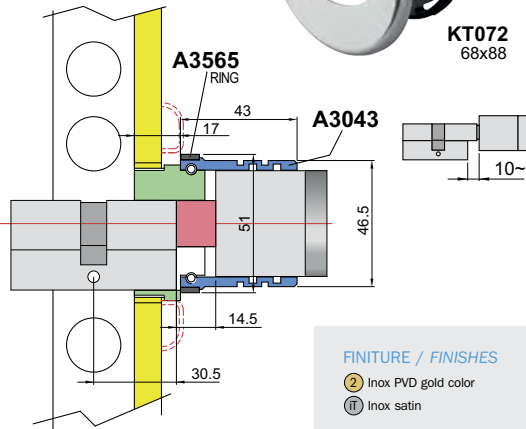
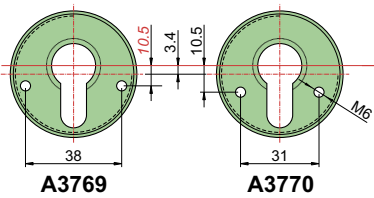
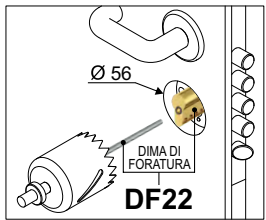
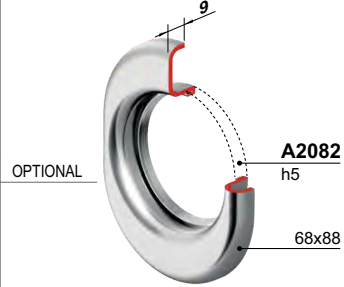
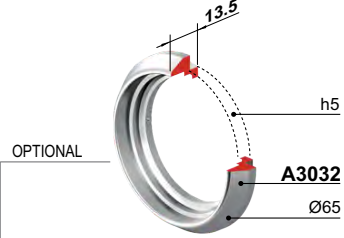

FINITURE / FINISHES

- ② Inox PVD gold color
- Ⓜ Inox satin

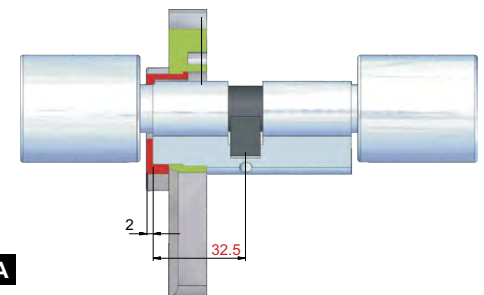
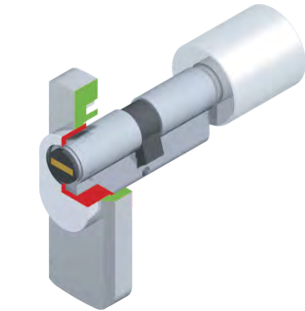
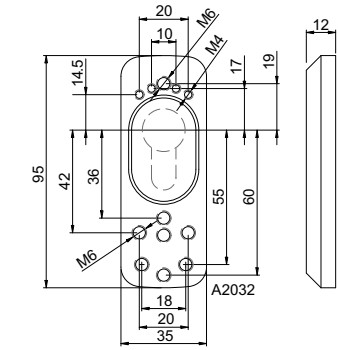
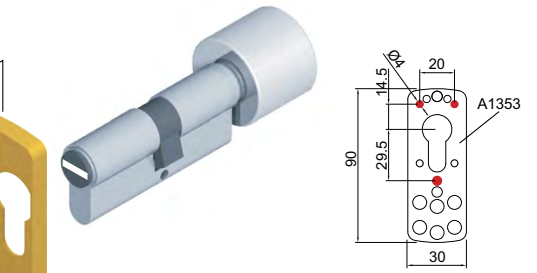
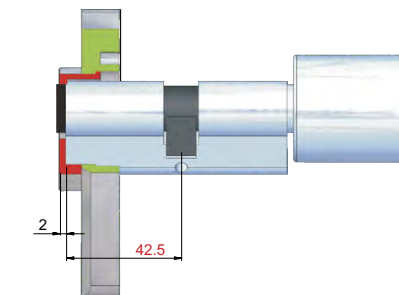
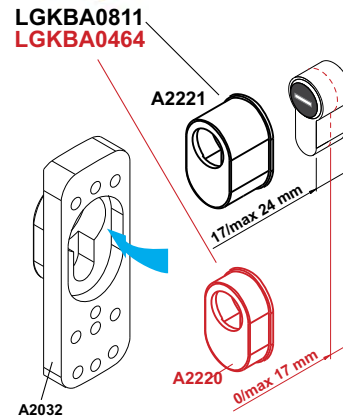
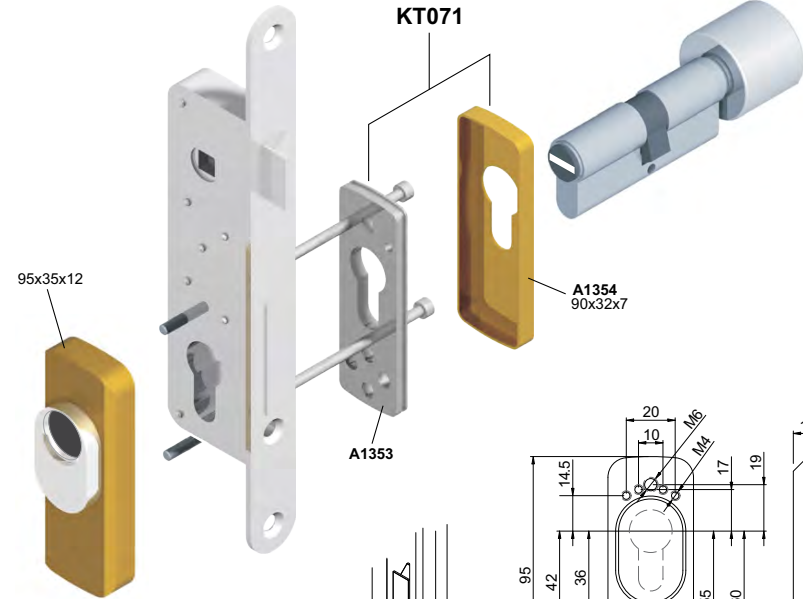

X CISA serie 16 / 46

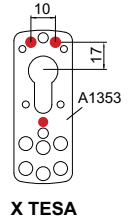

X TESA

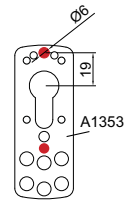

X ISEO
X MULTIBLINDO

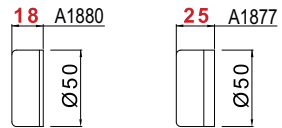
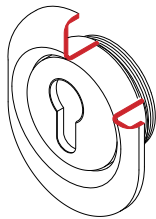
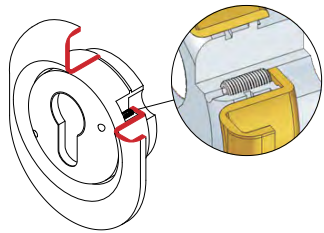
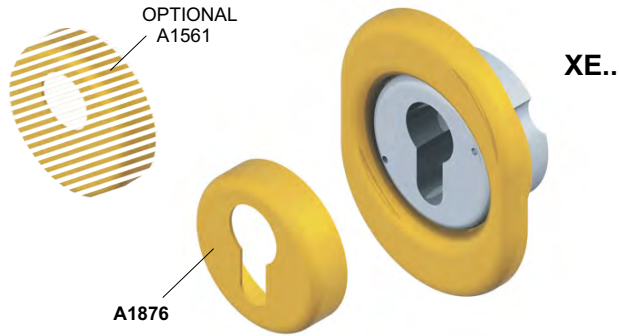

	STANDARD / TESA	XE2000018	XE2000025
	X ATRA	XE3000018	XE3000025

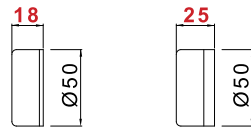

	STANDARD / TESA	XE2500018	XE2500025
	X ATRA	XE3500018	XE3500025

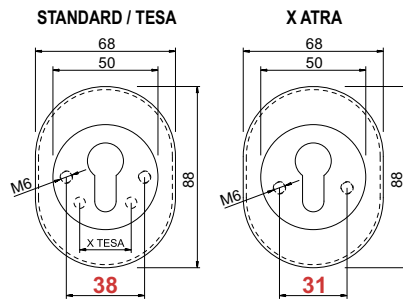
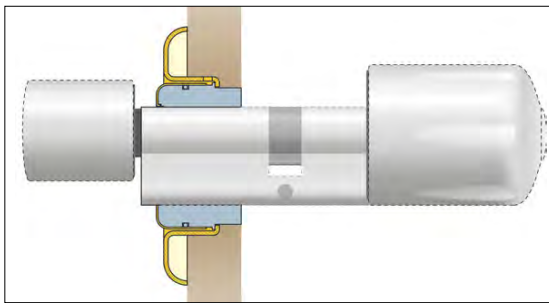

FINITURE / FINISHES

- (C) Cromo lucido
Bright Chrome
- (B) Bronzo
Bronze
- (TT) Ottone satinato
Satin Brass
- (IT) Inox satinato
Stainless steel
- (T) Cromo satinato
Satin Chrome
- (2) PVD Ottone
PVD Brass
- (BS) Bronzo satinato
Satin Bronze

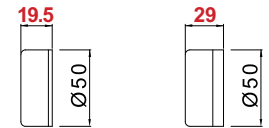
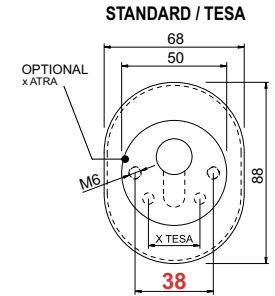
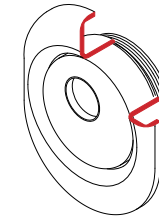
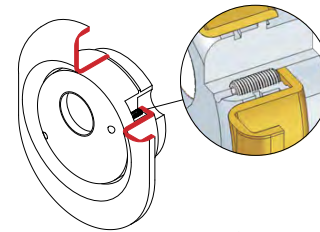
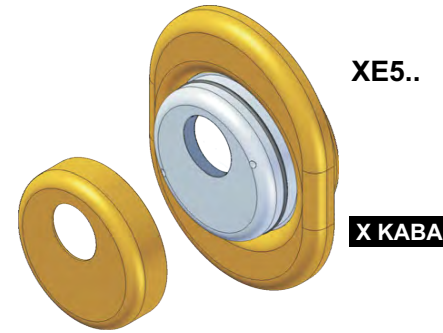

	STANDARD / TESA	XE500-32	XE500-42
--	-----------------	-----------------	-----------------

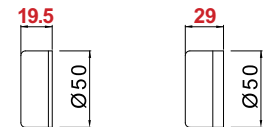

	STANDARD / TESA	XE550-32	XE550-42
--	-----------------	-----------------	-----------------

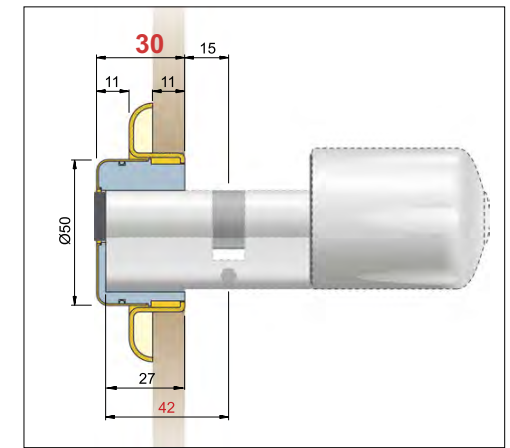
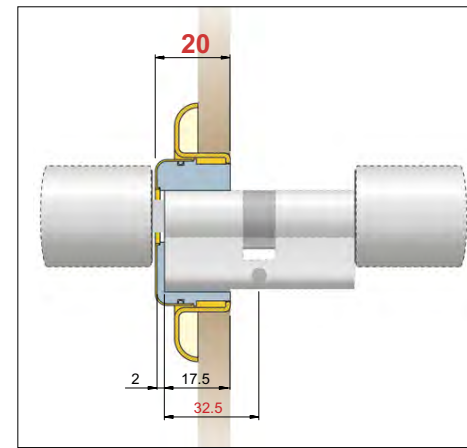

FINITURE / FINISHES

- (C) Cromo lucido
Bright Chrome
- (B) Bronzo
Bronze
- (TT) Ottone satinato
Satin Brass
- (IT) Inox satinato
Stainless steel
- (T) Cromo satinato
Satin Chrome
- (2) PVD Ottone
PVD Brass
- (BS) Bronzo satinato
Satin Bronze

CONTRO DEF

CONTRO DEF



CD2000 (x viti M6)
CD2008 (x viti M8)
CD3000 x ATRA



VIDEO

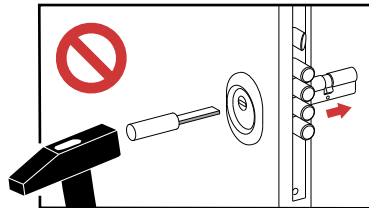

CD2100 (x viti M6)
CD2108 (x viti M8)
CD3100 x ATRA



VIDEO

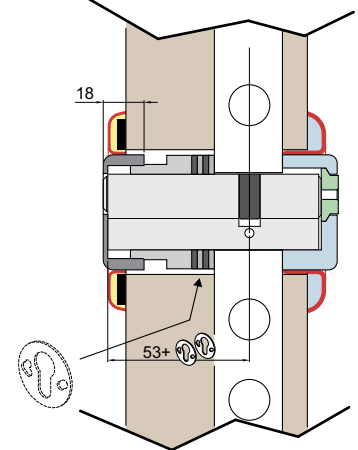
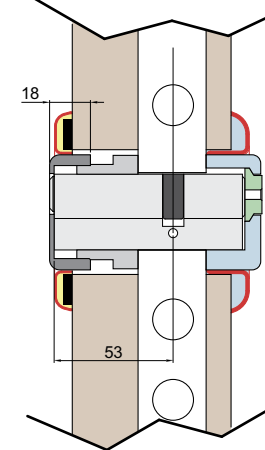
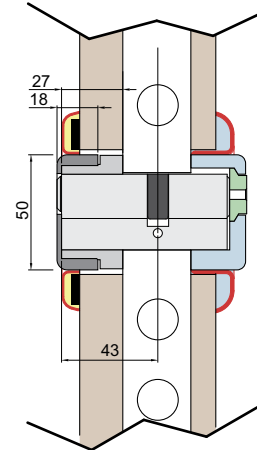
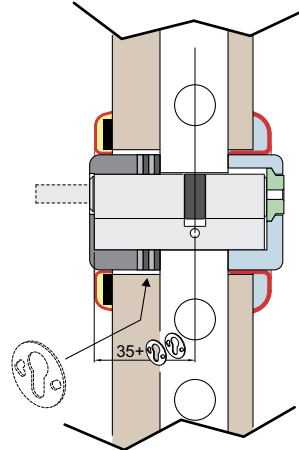
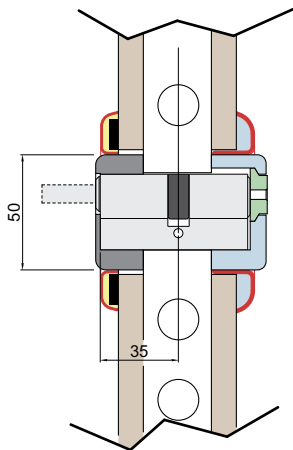
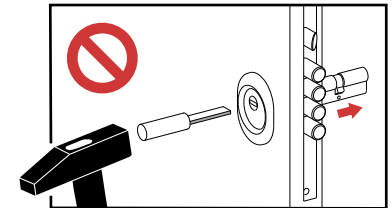

FINITURE / FINISHES

- C** Cromo lucido / Bright Chrome
- T** Cromo satinato / Satin Chrome
- OT** Ottone satinato / Satin Brass
- BS** Bronzo satinato / Satin Bronze
- B** Bronzo / Bronze
- 2** PVD Ottone / PVD Brass
- IT** Inox satinato / Satin stainless steel

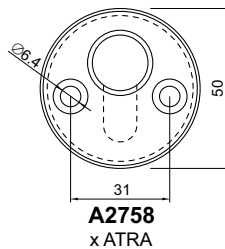
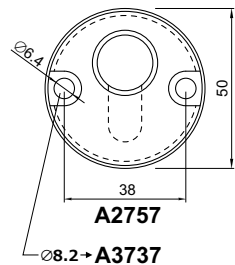
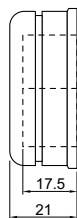

FINITURE / FINISHES

- C** Cromo lucido / Bright Chrome
- T** Cromo satinato / Satin Chrome
- OT** Ottone satinato / Satin Brass
- BS** Bronzo satinato / Satin Bronze
- B** Bronzo / Bronze
- 2** PVD Ottone / PVD Brass
- IT** Inox satinato / Satin stainless steel

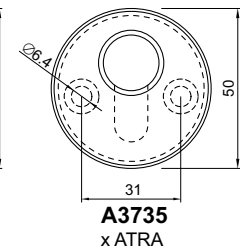
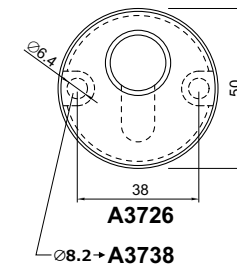
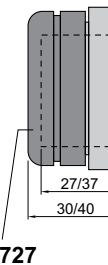

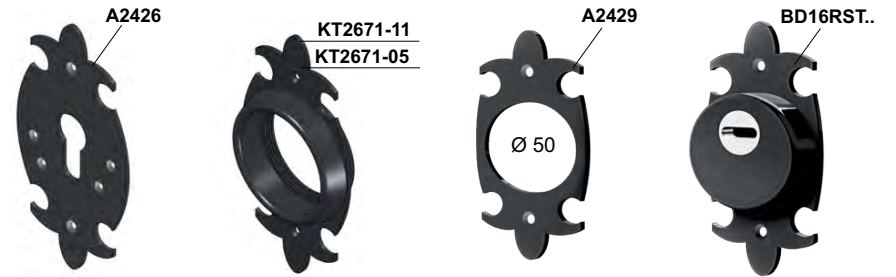
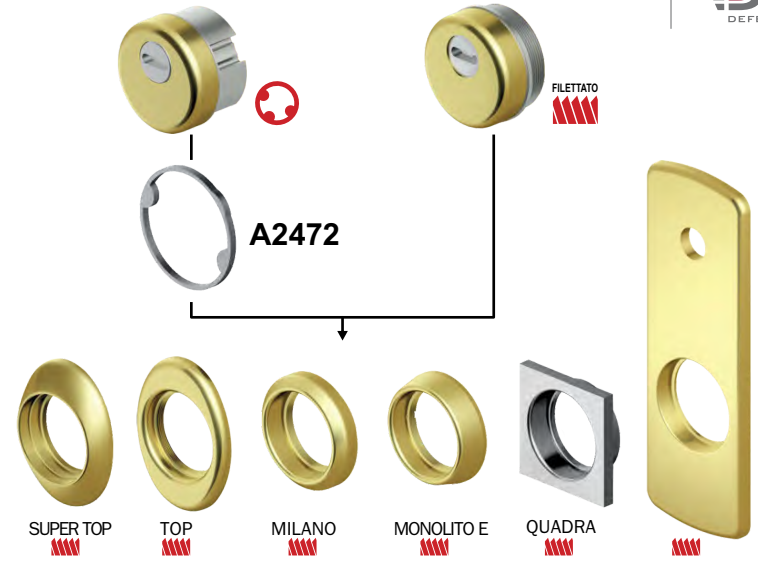

PLACCA PER CILINDRI ELETTRICI
ELECTRONIC CYLINDER PROTECTIONS

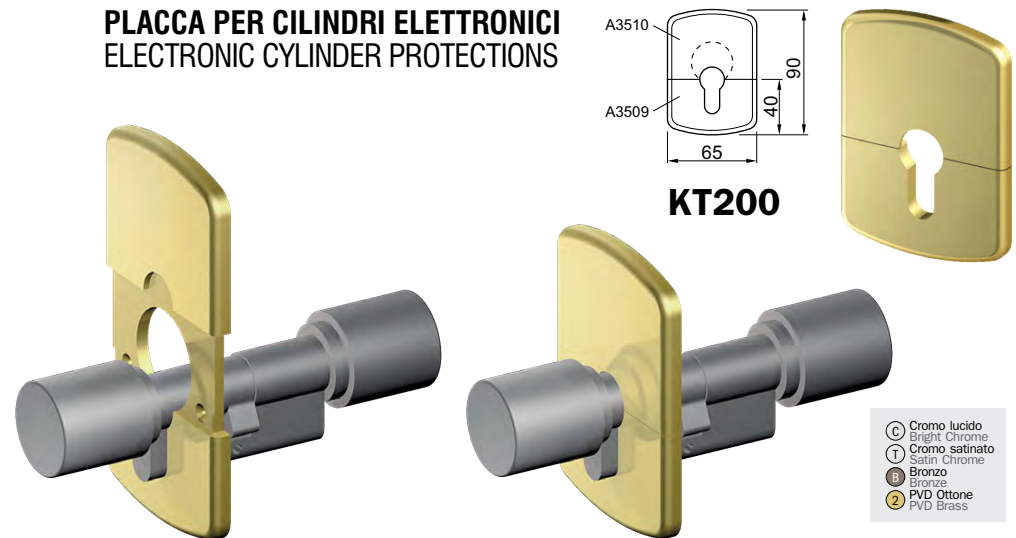

- ⓪ Cromo lucido / Bright Chrome
- Ⓛ Cromo satinato / Satin Chrome
- Ⓛ Bronzo / Bronze
- Ⓛ PVD Ottone / PVD Brass

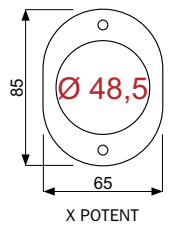
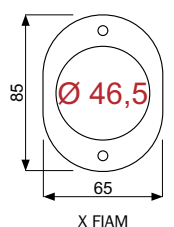
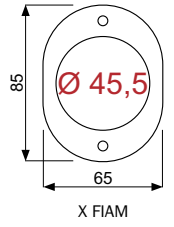
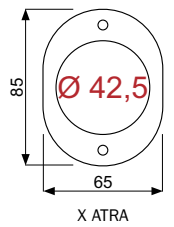
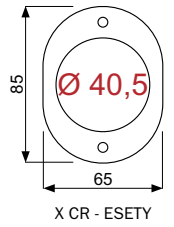
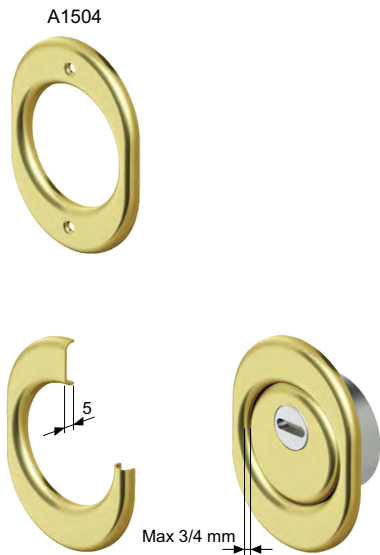
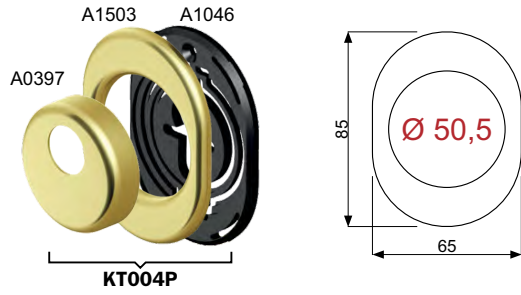

FINITURE / FINISHES

- C** Cromo lucido / Bright Chrome
- L** Ottone lucido / Bright Brass
- T** Cromo satinato / Satin Chrome
- 2** PVD Ottone / PVD Brass
- S** Cromo opaco / Mat. Chrome
- BS** Bronzo satinato / Satin Bronze
- B** Bronzo / Bronze
- N** Nero / Black

FINITURE / FINISHES

- C** Cromo lucido / Bright Chrome
- T** Cromo satinato / Satin Chrome
- S** Cromo opaco / Mat. Chrome
- B** Bronzo / Bronze
- L** Ottone lucido / Bright Brass
- 2** PVD Ottone / PVD Brass

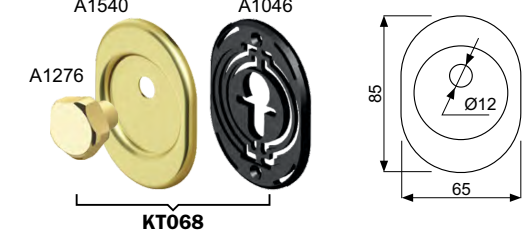
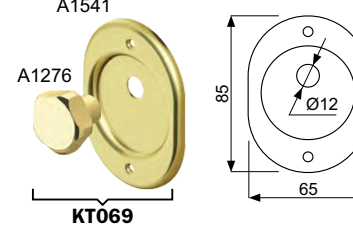
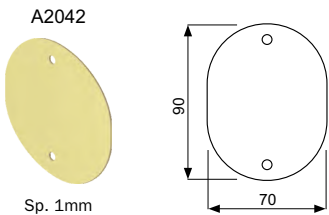
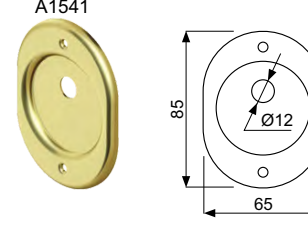
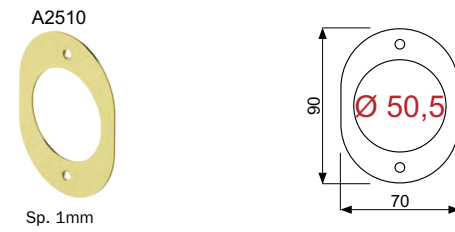
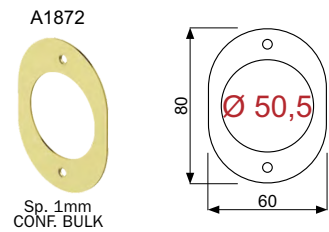
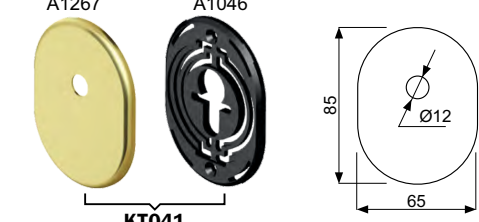
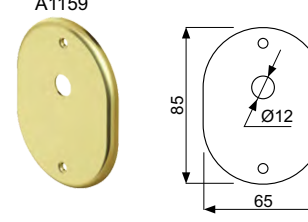
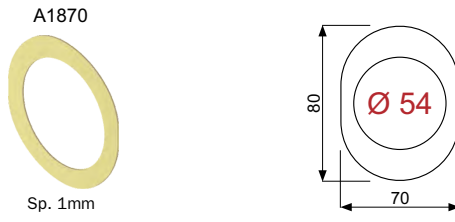
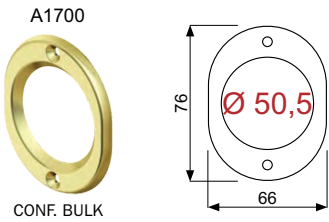
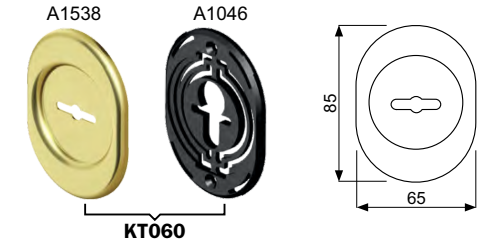
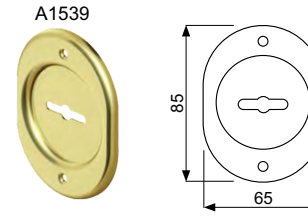
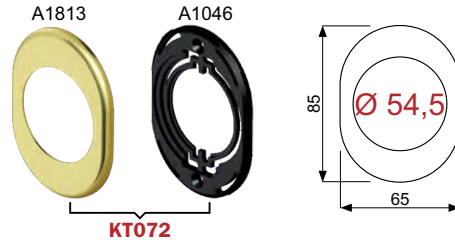
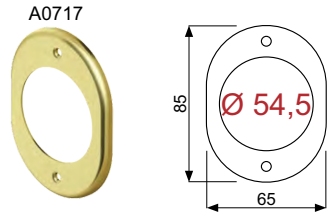
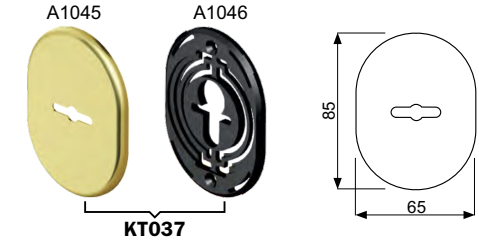
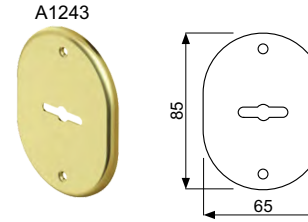
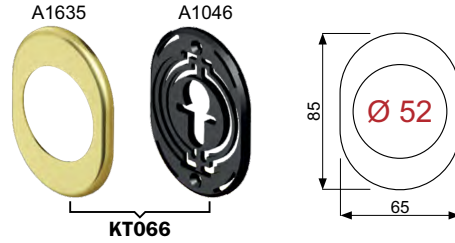
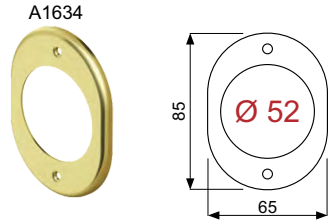

FINITURE / FINISHES

- C Cromo lucido / Bright Chrome
- T Cromo satinato / Satin Chrome
- S Cromo opaco / Mat. Chrome
- B Bronzo / Bronze
- L Ottone lucido / Bright Brass
- 2 PVD Ottone / PVD Brass
- BS Bronzo satinato / Satin Bronze

FINITURE / FINISHES

- C Cromo lucido / Bright Chrome
- T Cromo satinato / Satin Chrome
- S Cromo opaco / Mat. Chrome
- B Bronzo / Bronze
- L Ottone lucido / Bright Brass
- 2 PVD Ottone / PVD Brass

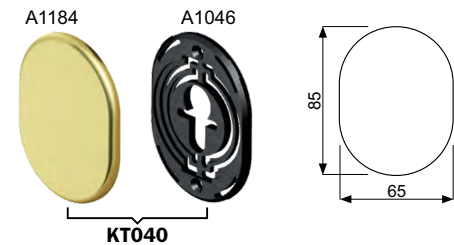
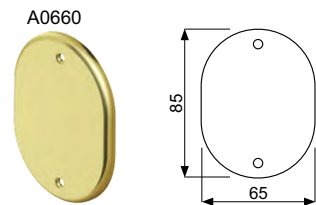
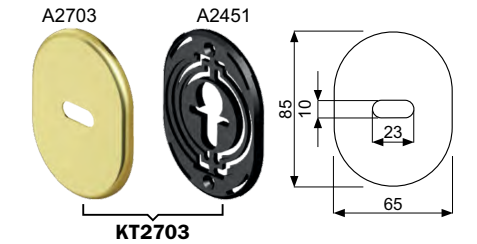
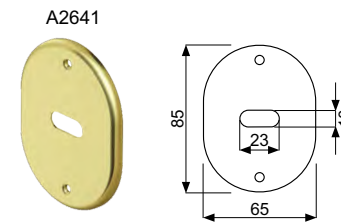
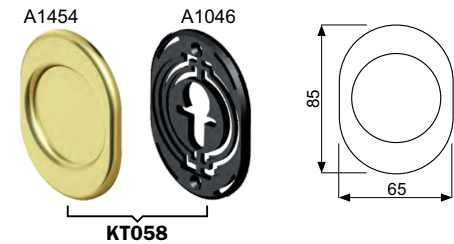
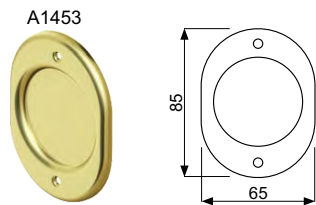
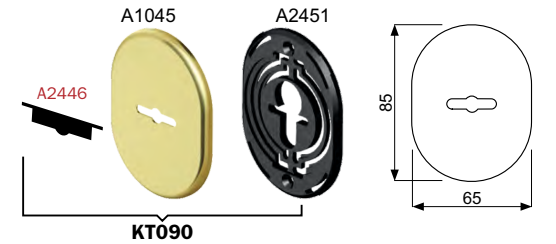
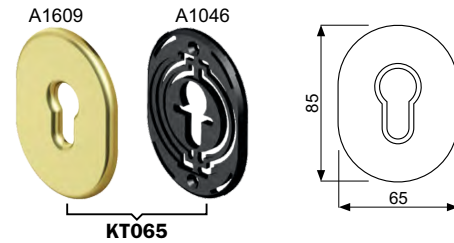
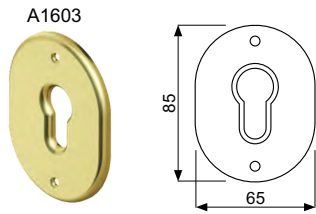
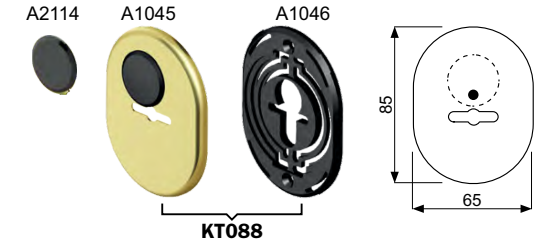
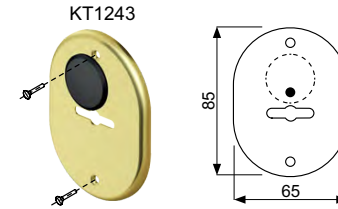
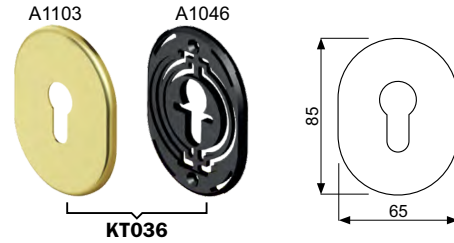
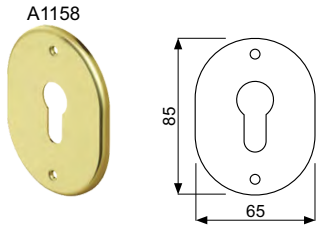
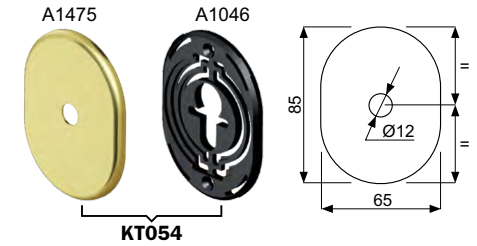
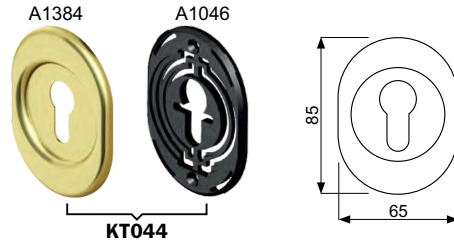
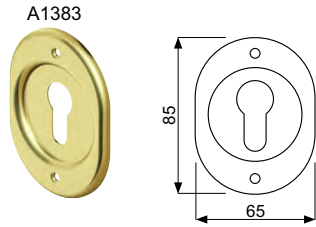

FINITURE / FINISHES

- C Cromo lucido
Bright Chrome
- T Cromo satinato
Satin Chrome
- S Cromo opaco
Mat Chrome
- B Bronzo
Bronze
- L Ottone lucido
Bright Brass
- 2 PVD Ottone
PVD Brass

FINITURE / FINISHES

- C Cromo lucido
Bright Chrome
- T Cromo satinato
Satin Chrome
- S Cromo opaco
Mat Chrome
- B Bronzo
Bronze
- L Ottone lucido
Bright Brass
- 2 PVD Ottone
PVD Brass

FINITURE / FINISHES

- C Cromo lucido Bright Chrome
- T Cromo satinato Satin Chrome
- S Inox satinato Stainless steel
- B Bronzo Bronze
- 2 PVD Ottone PVD Brass
- BS Bronzo satinato Satin Bronze

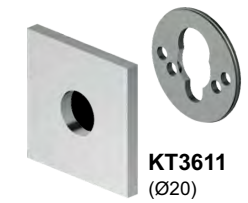
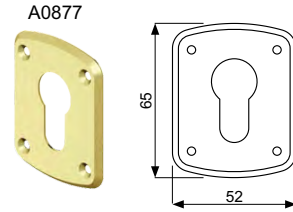
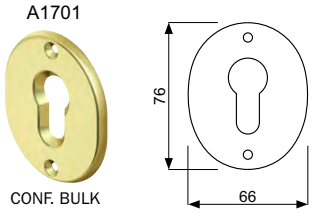

(dimensioni 60x60x6 mm)

SERIE KUBO - 65x65x6 mm

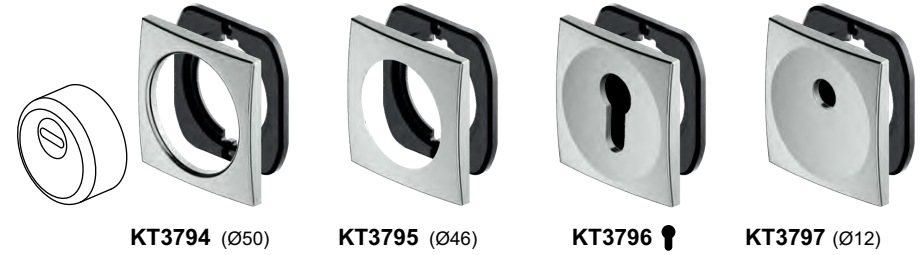

SERIE QUADRY - 64x84x6 mm

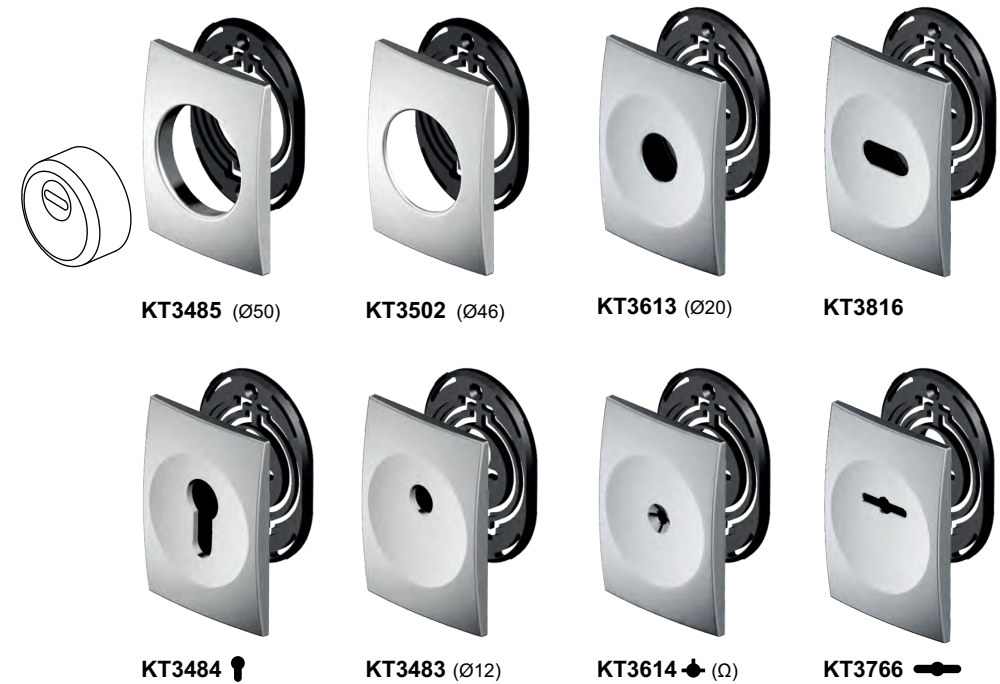

BIG SIZE

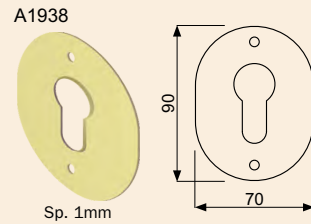
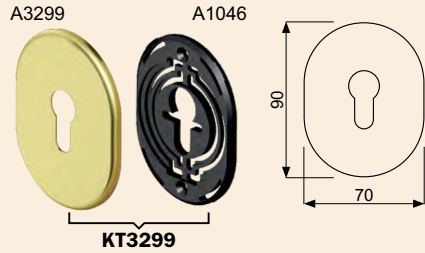
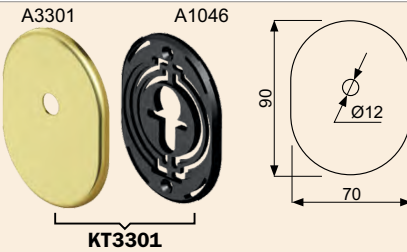

SMALL SIZE

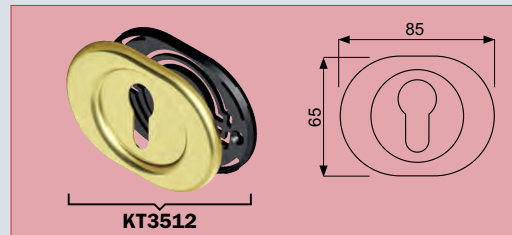
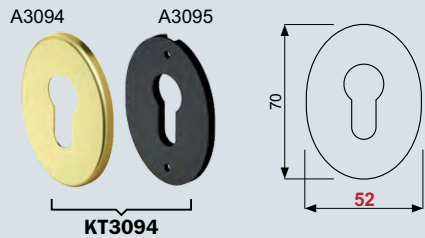
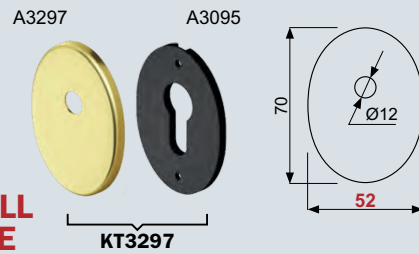
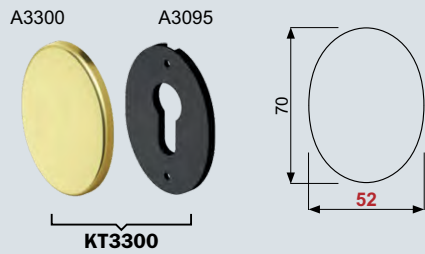

FINITURE / FINISHES

- C Cromo lucido Bright Chrome
- T Cromo satinato Satin Chrome
- S Cromo opaco Mat Chrome
- B Bronzo Bronze
- L Ottone lucido Bright Brass
- 2 PVD Ottone PVD Brass

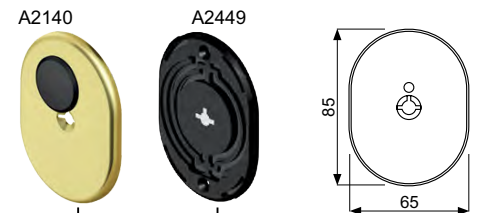
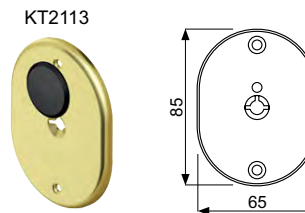
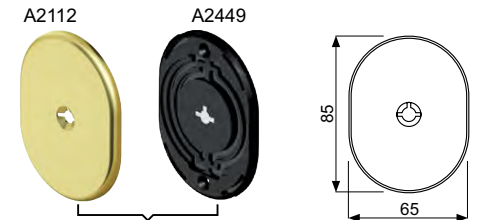
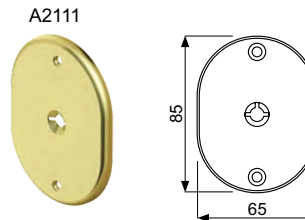
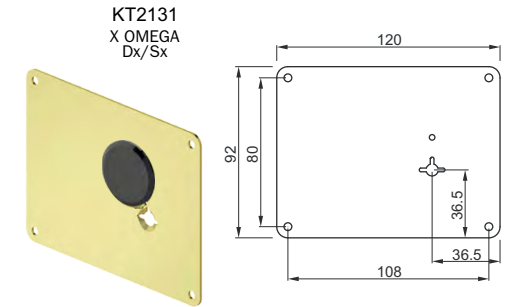
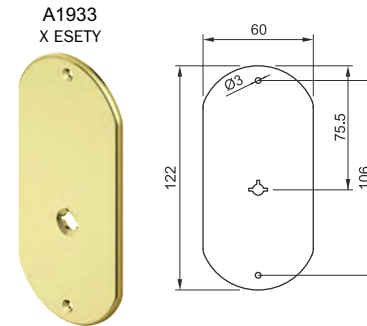
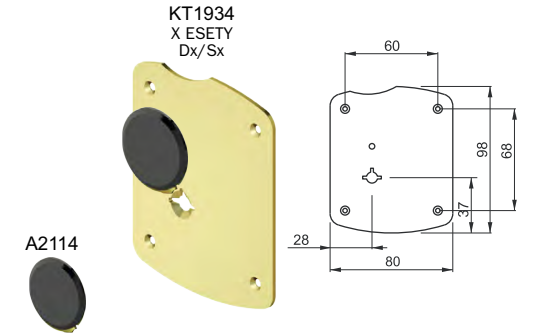
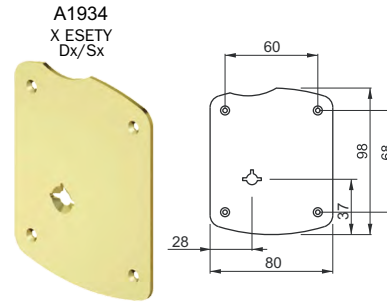
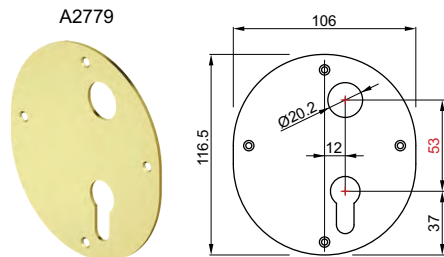
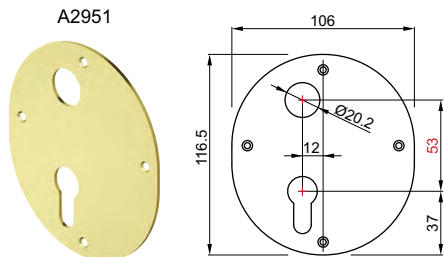
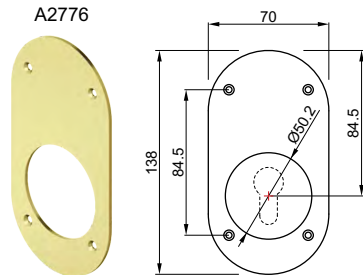
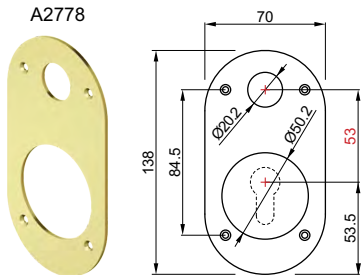
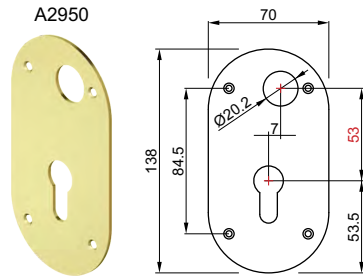
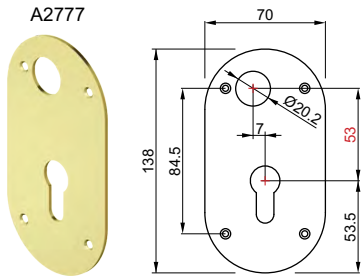

FINITURE / FINISHES

- C** Cromo lucido / Bright Chrome
- T** Cromo satinato / Satin Chrome
- B** Bronzo / Bronze
- 2** PVD Ottone / PVD Brass
- BS** Bronzo satinato / Satin Bronze

FINITURE / FINISHES

- C** Cromo lucido / Bright Chrome
- T** Cromo satinato / Satin Chrome
- IT** Inox satinato / Stainless steel
- B** Bronzo / Bronze
- L** Ottone lucido / Bright Brass
- 2** PVD Ottone / PVD Brass
- BS** Bronzo satinato / Satin Bronze

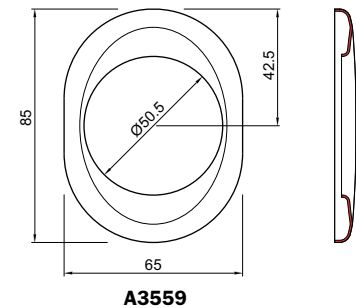
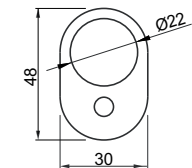
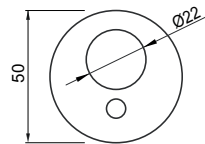
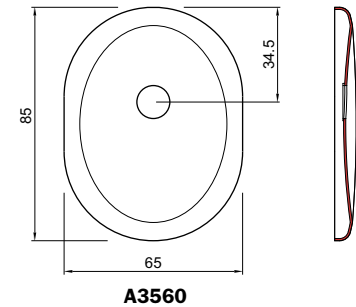
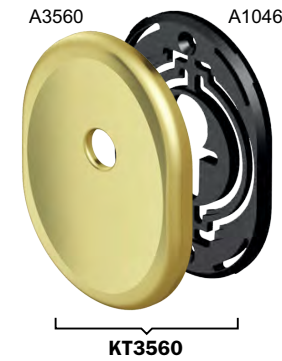
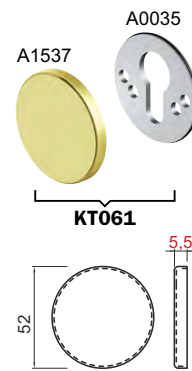
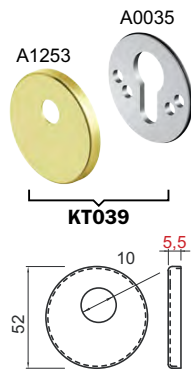
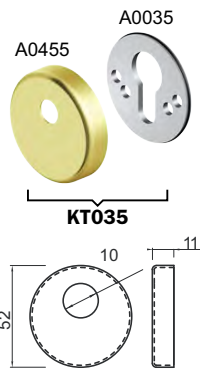
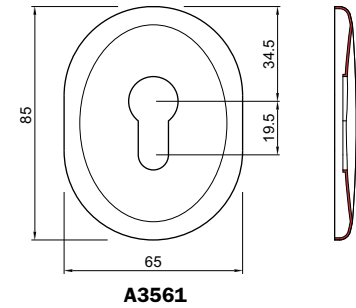
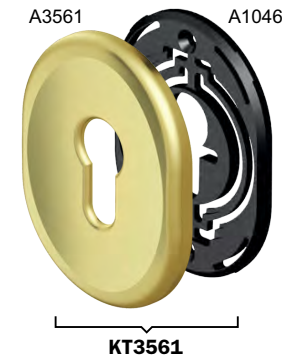
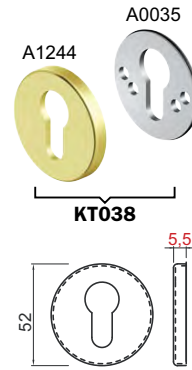
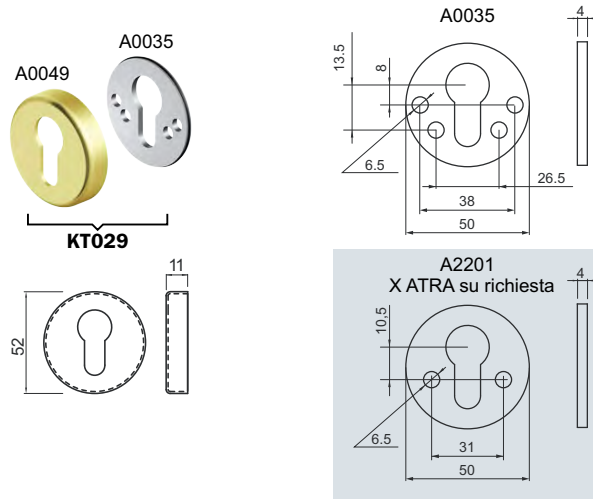

FINITURE / FINISHES

- C** Cromo lucido / Bright Chrome
- L** Ottone lucido / Bright Brass
- T** Cromo satinato / Satin Chrome
- 2** PVD Ottone / PVD Brass
- S** Cromo opaco / Mat. Chrome
- BS** Bronzo satinato / Satin Bronze
- IT** Inox satinato / Stainless steel
- N** Nero / Black
- B** Bronzo / Bronze

A2250
X ATRA
Dx/Sx



A1608
X ATRA
Dx/Sx

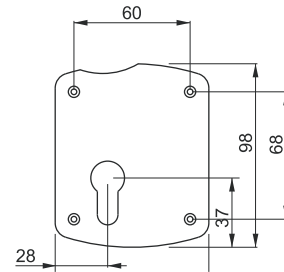

A2076



A1964
Dx/Sx

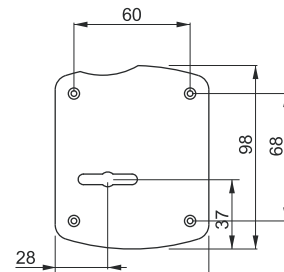

A1894
X MOTTURA

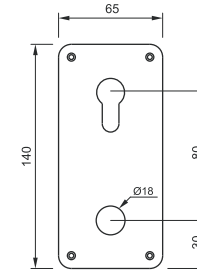

A2493
X Rif.01

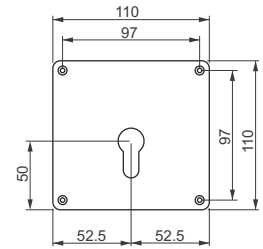

A1911
X Jewel

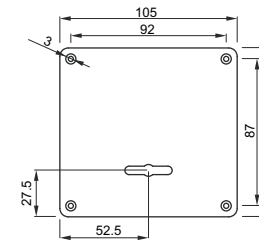

A1893
Dx/Sx
X MOTTURA
95066

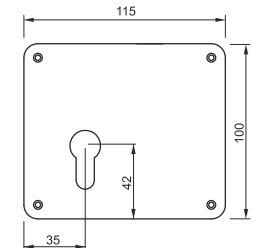

X Jewel art. 1301 1303 (X Asiaghi)

A2499

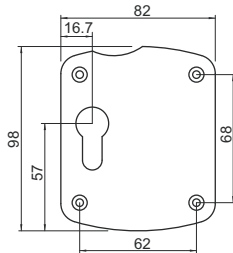

A2500

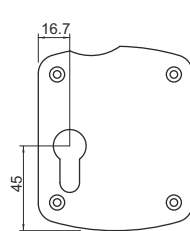

A2501

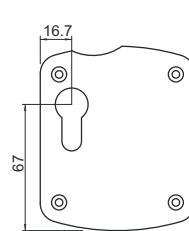

A2502

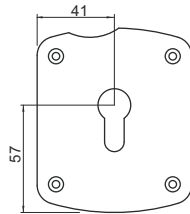

A2503

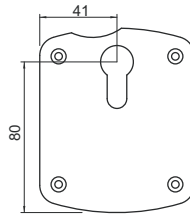

A2504

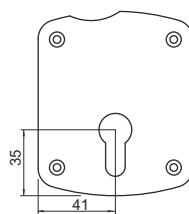

A2016
X MOTTURA
95066



A2235
Dx/Sx
X MOTTURA
95066

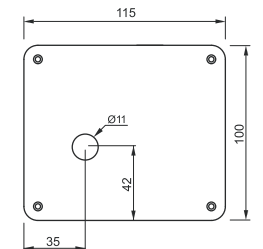

FINITURE / FINISHES

- C Cromo lucido / Bright Chrome
- T Cromo satinato / Satin Chrome
- S Cromo opaco / Mat Chrome
- B Bronzo / Bronze
- L Ottone lucido / Bright Brass
- 2 PVD Ottone / PVD Brass

FINITURE / FINISHES

- C Cromo lucido / Bright Chrome
- T Inox satinato / Stainless steel
- B Bronzo / Bronze
- L Ottone lucido / Bright Brass
- 2 PVD Ottone / PVD Brass
- BS Bronzo satinato / Satin Bronze

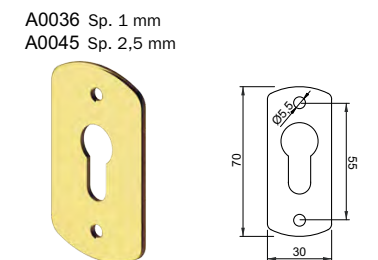
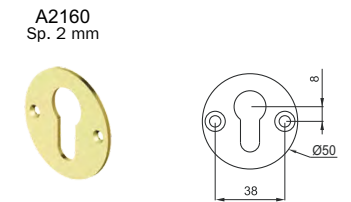
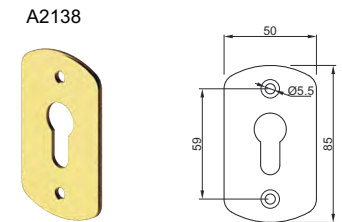
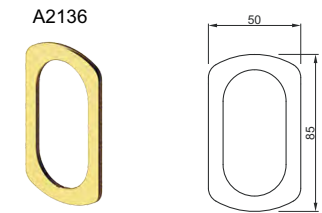
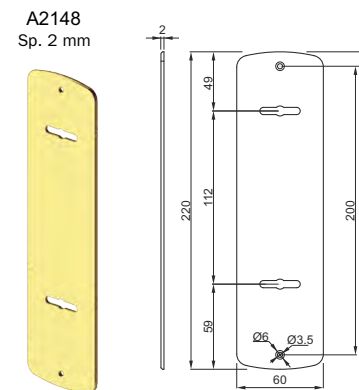
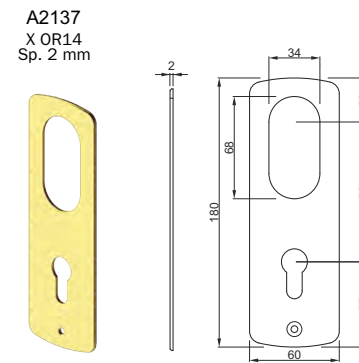
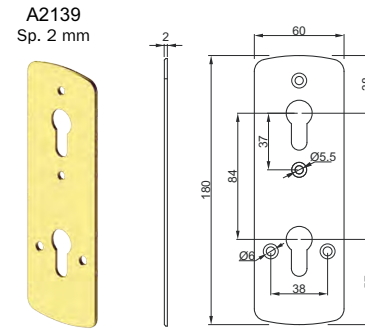
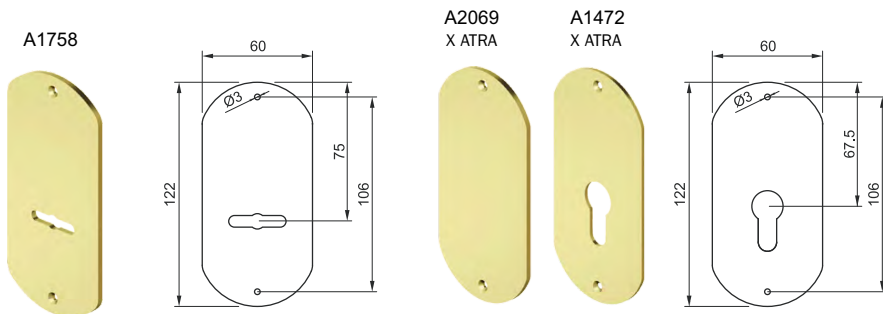
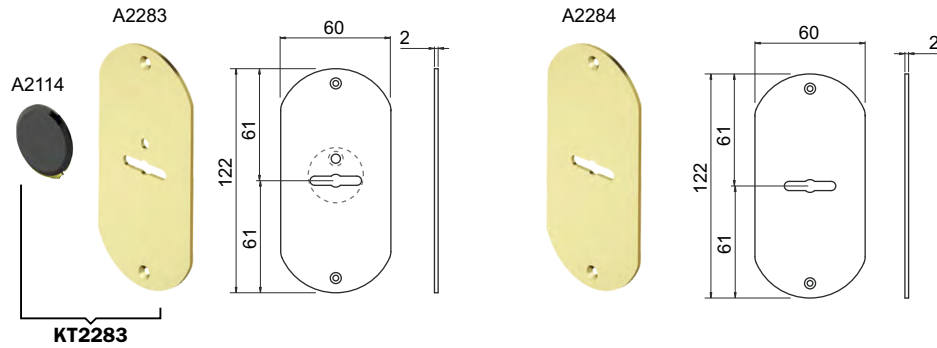

FINITURE / FINISHES

- Cromo lucido / Bright Chrome
- Inox satinato / Stainless steel
- Bronzo / Bronze
- PVD Ottone / PVD Brass
- Bronzo satinato / Satin Bronze

FINITURE / FINISHES

- Cromo lucido / Bright Chrome
- Inox satinato / Stainless steel
- Bronzo / Bronze
- Ottone lucido / Bright Brass
- PVD Ottone / PVD Brass

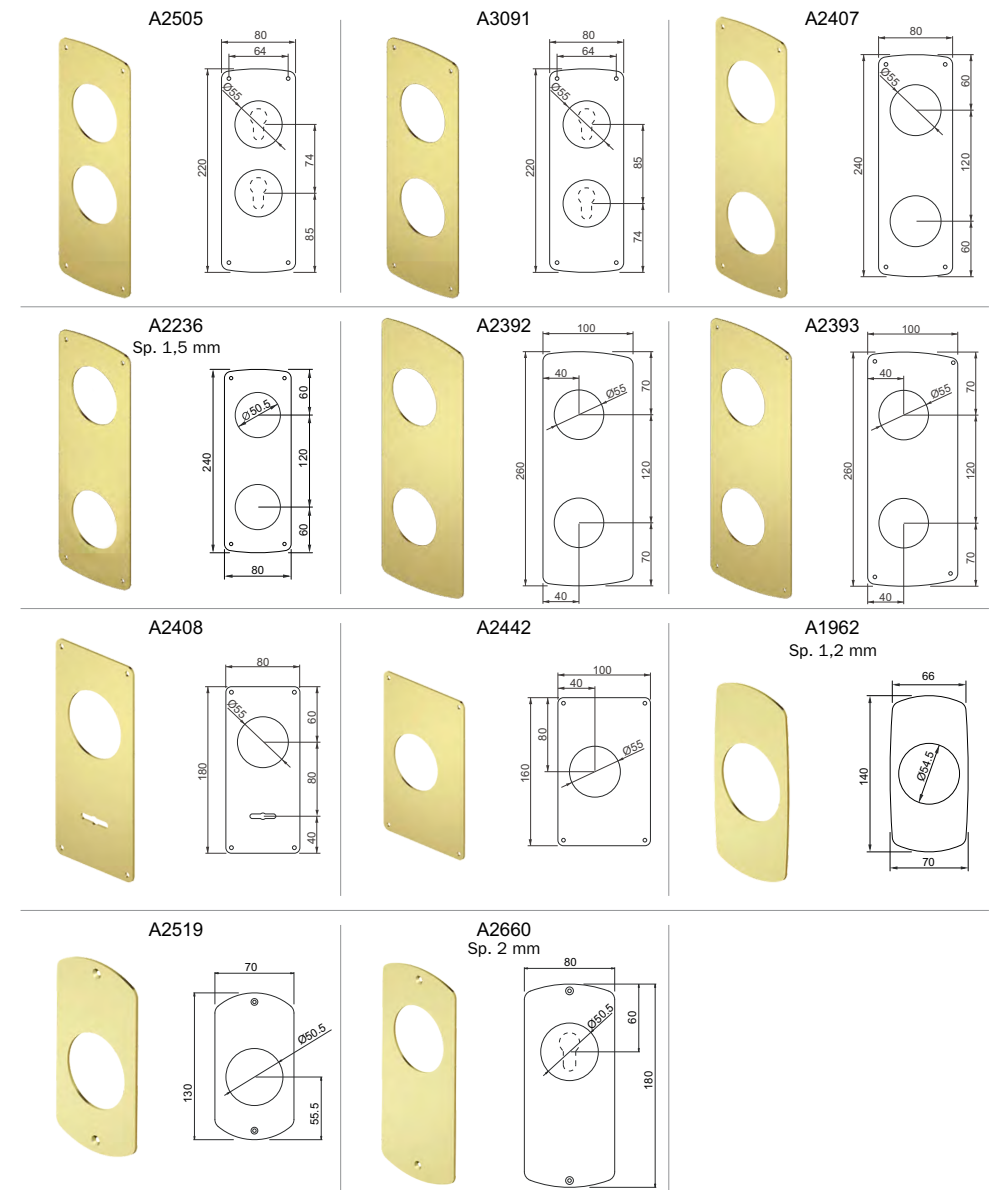
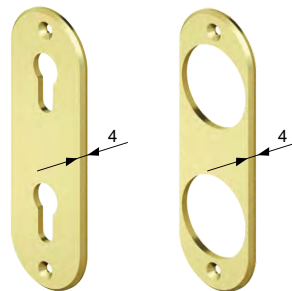
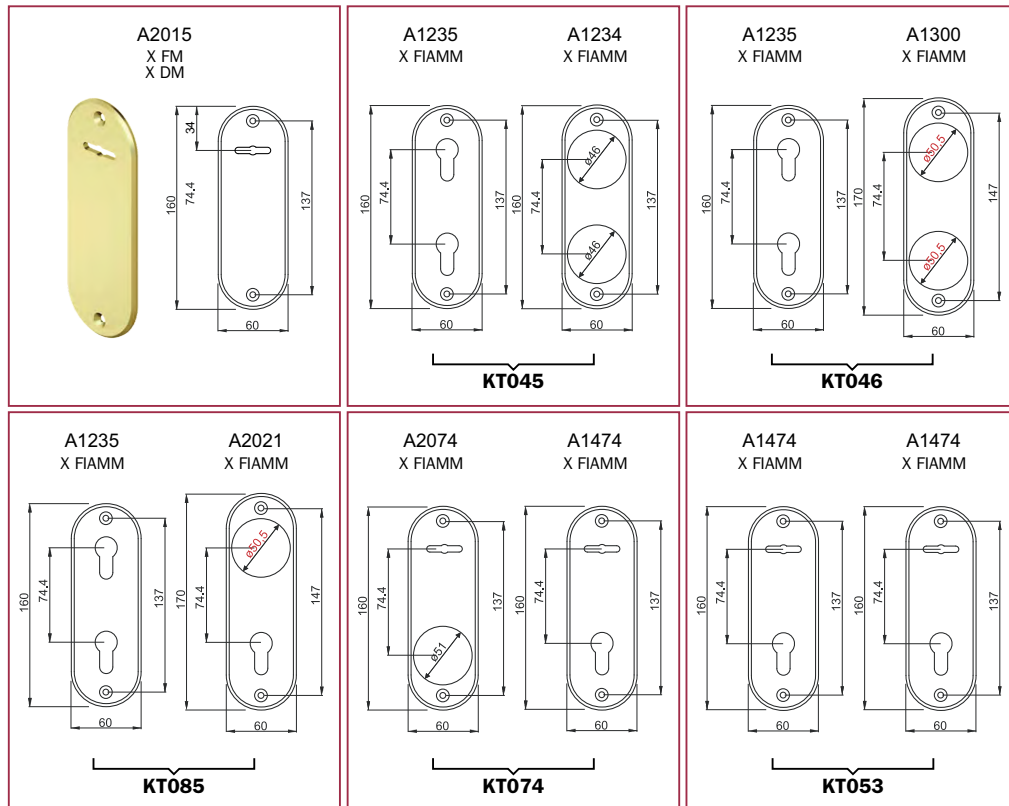

FINITURE / FINISHES

- C Cromo lucido
Bright Chrome
- T Inox satinato
Stainless steel
- B Bronzo
Bronze
- L Ottone lucido
Bright Brass
- 2 PVD Ottone
PVD Brass

FINITURE / FINISHES

- C Cromo lucido
Bright Chrome
- T Inox satinato
Stainless steel
- B Bronzo
Bronze
- 2 PVD Ottone
PVD Brass

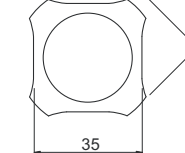
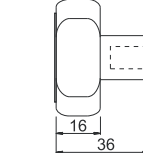
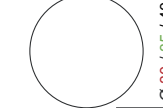
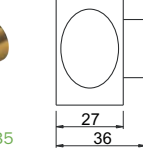
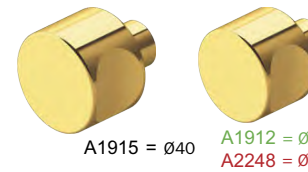
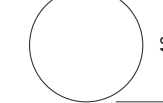
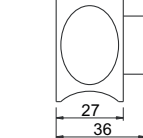
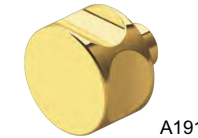
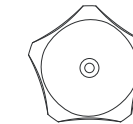
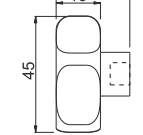
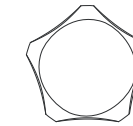
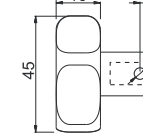
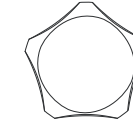
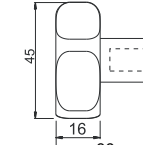
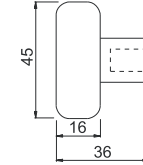
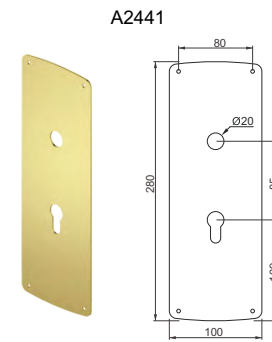
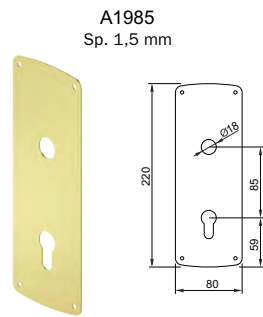
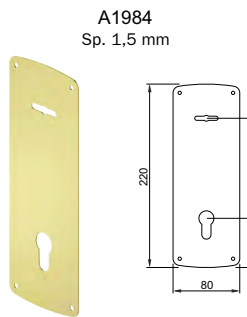
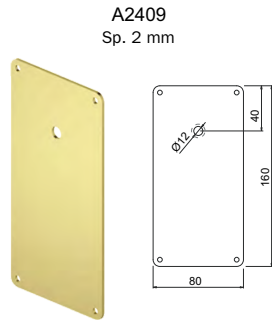
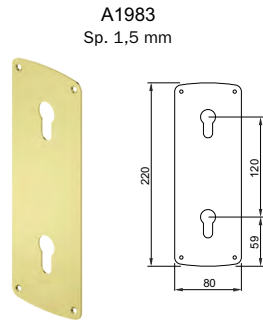
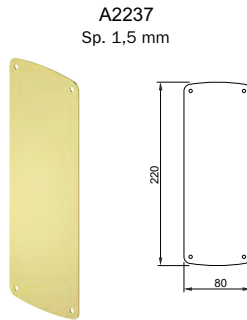
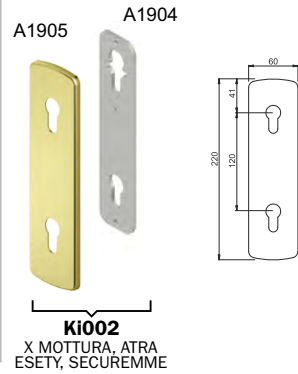
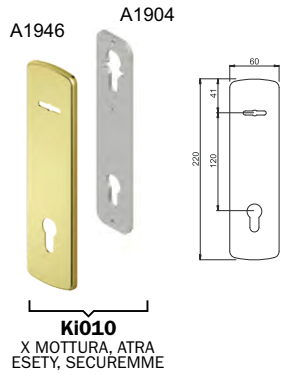
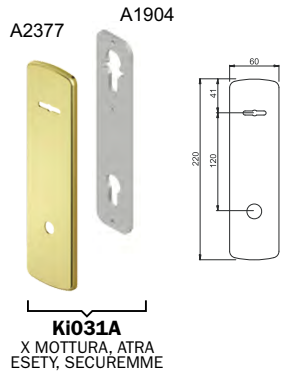

FINITURE / FINISHES

- C** Cromo lucido / Bright Chrome
- T** Cromo satinato / Satin Chrome
- IT** Inox satinato / Stainless steel
- B** Bronzo / Bronze
- L** Ottone lucido / Bright Brass
- 2** PVD Ottone / PVD Brass

FINITURE / FINISHES

- C** Cromo lucido / Bright Chrome
- T** Cromo satinato / Satin Chrome
- B** Bronzo / Bronze
- 2** PVD Ottone / PVD Brass
- BS** Bronzo satinato / Satin Bronze

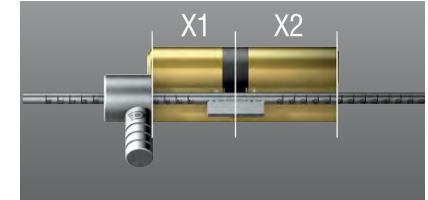
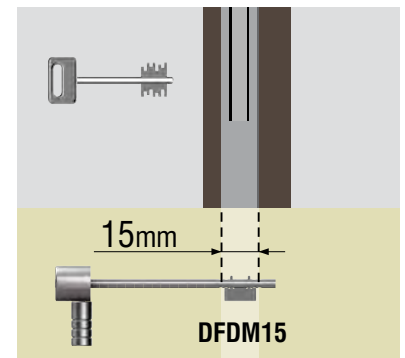
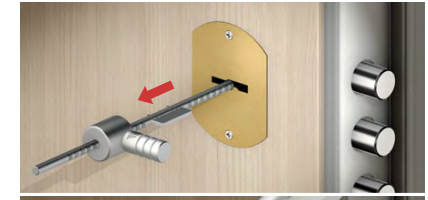
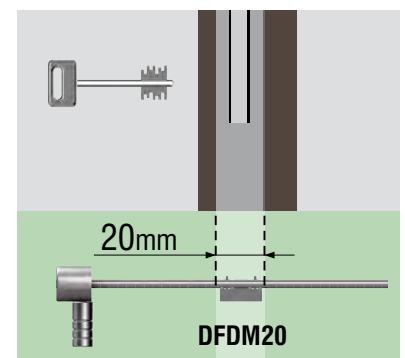
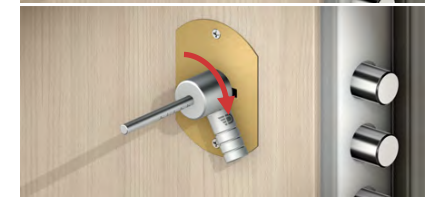
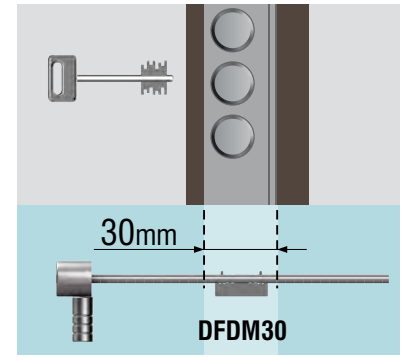
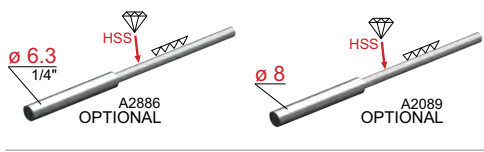
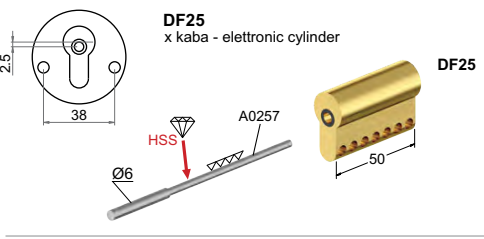
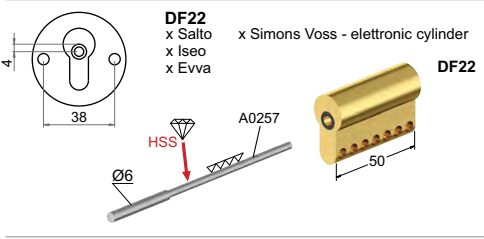
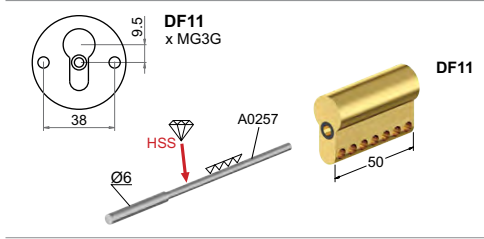
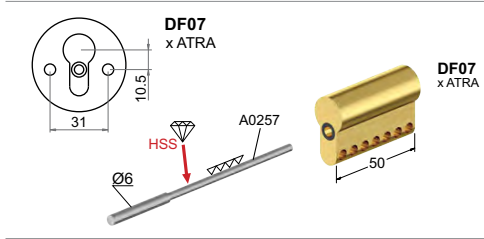
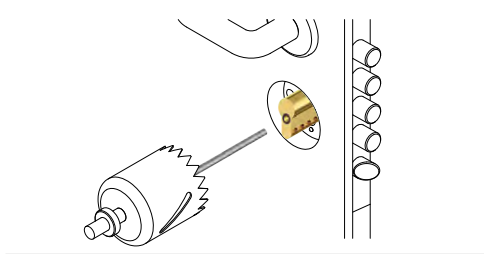
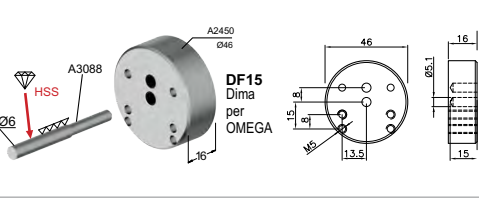
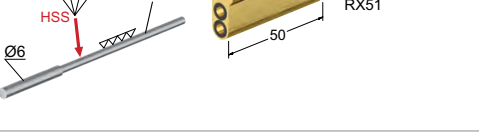
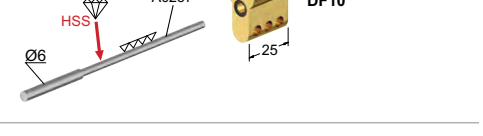
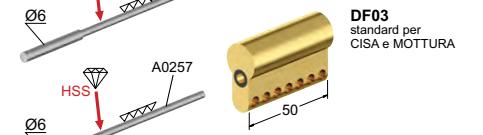
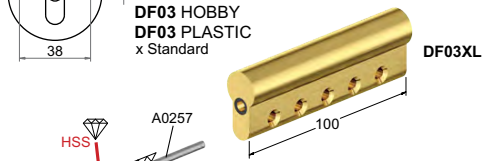

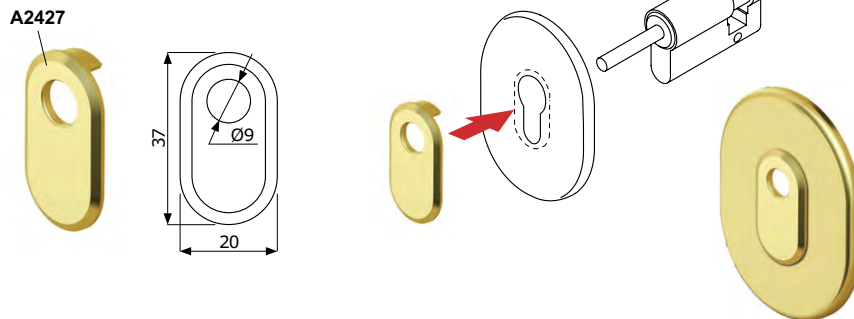
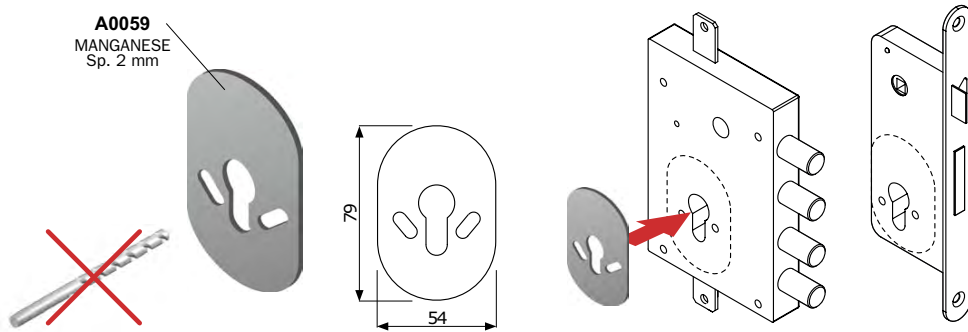
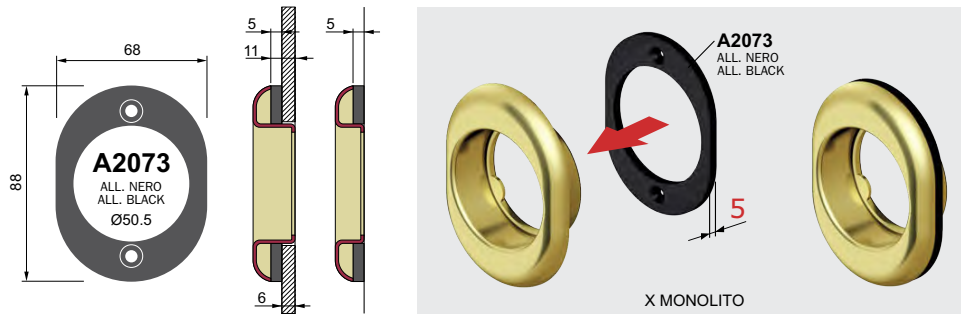

FINITURE / FINISHES

- C Cromo lucido / Bright Chrome
- B Bronzo / Bronze
- L Ottone lucido / Bright Brass
- T Cromo satinato / Satin Chrome
- N Nero / Black

Ø 50	UNIVERSAL			
	A1565 1mm			
	A1566 2mm			
	A2755 5mm			
	A2756 10mm			
	A2763 15mm			
Ø 45	A2578 2mm			
	X OMEGA A3375 2mm			
Ø 44	X FIAM			
	A0592 1mm A0591 2mm			
Ø 42	X TOTOR			
	A2633 2mm			
Ø 40	A3185 5mm			
	X ESETY X ATRA X CR			
	A1063 1mm A1056 2mm			

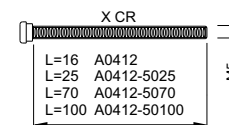
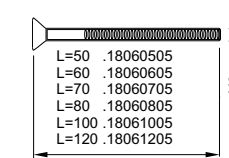
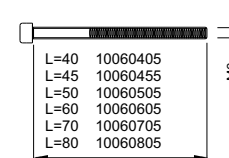
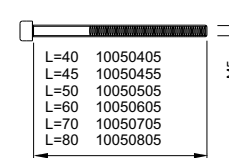
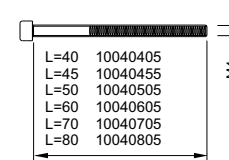
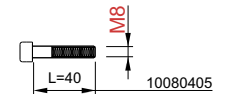
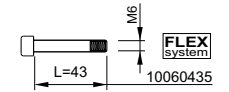



























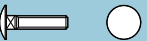













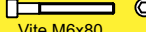



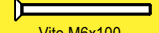

SERVICE KIT
430x290x55 mm
ACCIAIO INOX SATINATO

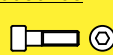

SERVICE KIT mini
328x258x52 mm

18061205 20 pz  Vite M6x120 testa svasata piana con cava esagonale CLASSE 10.9	18060705 20 pz  Vite M6x70 testa svasata piana con cava esagonale CLASSE 10.9	10060405 10 pz  Vite M6x40 testa cilindrica con cava esagonale CLASSE 12.9	28030052 20 pz  Grano M3x5 con cava esagonale	25060065 20 pz  Grano M6x6 con cava esagonale	25060405 20 pz  Grano M6x40 con cava esagonale
18061005 20 pz  Vite M6x100 testa svasata piana con cava esagonale CLASSE 10.9	18060605 20 pz  Vite M6x60 testa svasata piana con cava esagonale CLASSE 10.9	10050405 10 pz  Vite M5x40 testa cilindrica con cava esagonale CLASSE 8.8	31030125 100 pz  Vite autofilettante Ø 3x12 testa svasata piana a croce BRONZO	31030125 100 pz  Vite autofilettante Ø 3x12 testa svasata piana a croce ORO	
10061205 20 pz  Vite M6x120 testa cilindrica con cava esagonale CLASSE 12.9	10060705 20 pz  Vite M6x70 testa cilindrica con cava esagonale CLASSE 12.9	10080405 10 pz  Vite M8x40 testa cilindrica con cava esagonale	31030125 100 pz  Vite autofilettante Ø 3x12 testa svasata piana a croce ZINCATA	31040165 100 pz  Vite autofilettante Ø 4x16 testa svasata piana a croce ORO	
10061005 20 pz  Vite M6x100 testa cilindrica con cava esagonale CLASSE 12.9	10060605 20 pz  Vite M6x60 testa cilindrica con cava esagonale CLASSE 12.9	13060200 10 pz  Vite M6x20 testa cilindrica quadro sotto testa	30 30 pz  Dadi esagonali M6	30 30 pz  Rondella x M6	20 20 pz  Sfera Ø 4,8 acciaio 10 10 pz  A0716 Pin blocco SG 10 10 pz  O-Ring Ø 41x1,78
10060805 20 pz  Vite M6x80 testa cilindrica con cava esagonale CLASSE 12.9	10060505 20 pz  Vite M6x50 testa cilindrica con cava esagonale CLASSE 12.9	A1566 10 pz  Ø 50x2,5 Spessore universale	A2427N 12 pz  Adattatore codolo (Nero)	A1056 10 pz  Ø 40x2,5 Spessore universale	

18061205 10 pz  Vite M6x120 CLASSE 10.9	10060805 10 pz  Vite M6x80 CLASSE 12.9				
10061205 10 pz  Vite M6x120 CLASSE 12.9	10061005 10 pz  Vite M6x100 CLASSE 12.9				
A2578 10 pz  Spessore m 8 Ø 50x2,5	18061005 10 pz  Vite M6x100 CLASSE 10.9	10060705 10 pz  Vite M6x70 CLASSE 12.9	10060605 10 pz  Vite M6x60 CLASSE 12.9	10060505 10 pz  Vite M6x50 CLASSE 12.9	
10 10 pz  O-Ring Ø 41x1,78	A1566 10 pz  Spessore universale Ø 50x2,5	10080405 10 pz  Vite M8x40	31030125 4 pz  Vite Ø 3x12 ORO	31030125 4 pz  Vite Ø 3x12 BRONZO	31030125 4 pz  Vite Ø 3x12 ZINCATA

- C Cromo lucido
Bright Chrome
- T Cromo satinato
Satin Chrome
- B Bronzo
Bronze
- 85 Bronzo satinato
Satin Bronze
- L Ottone lucido
Bright Brass
- 2 PVD Ottone
PVD Brass
- 11 Inox satinato
Stainless steel
- 9 Oro anodizzato
Anodized Gold
- 6 Argento anodizzato
Anodized Silver

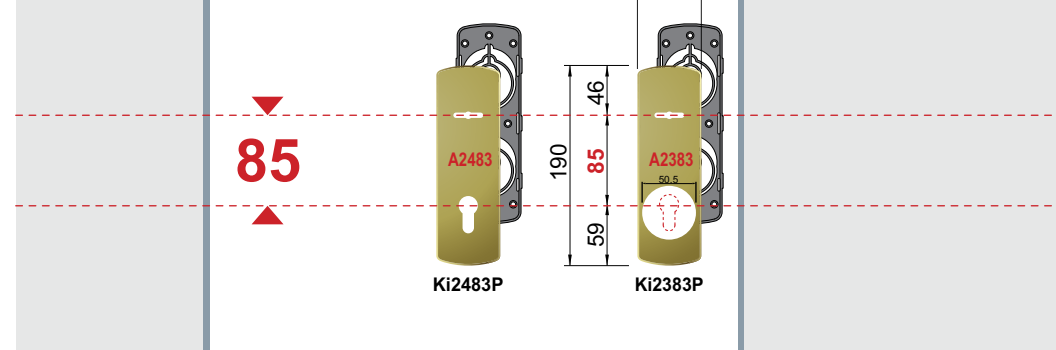
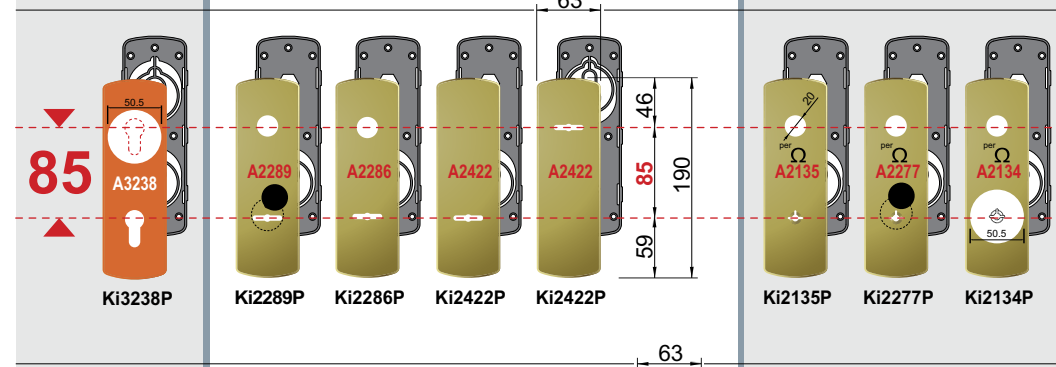
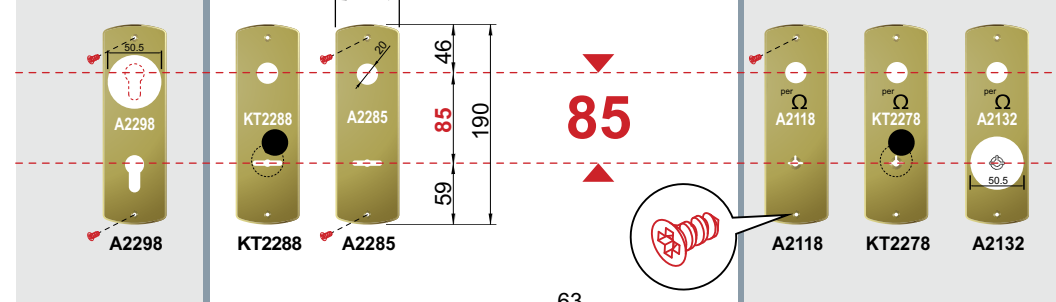
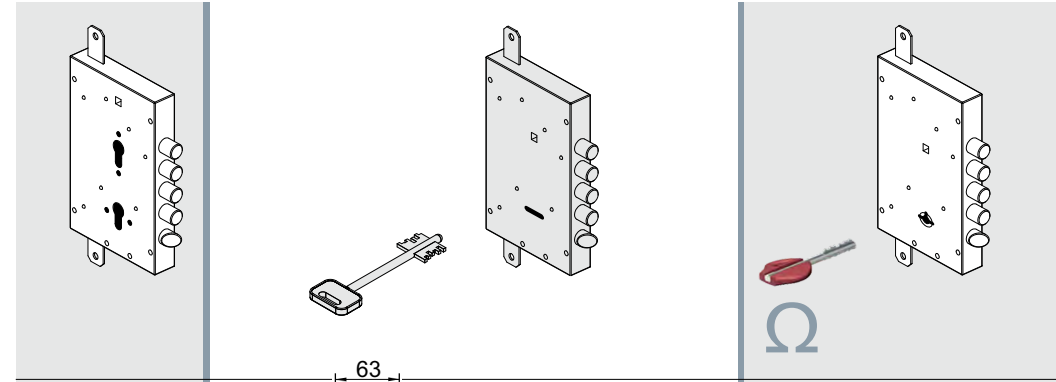
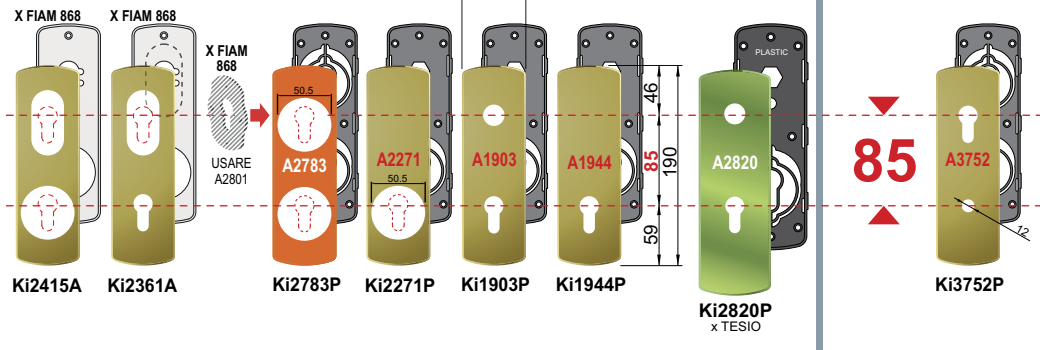
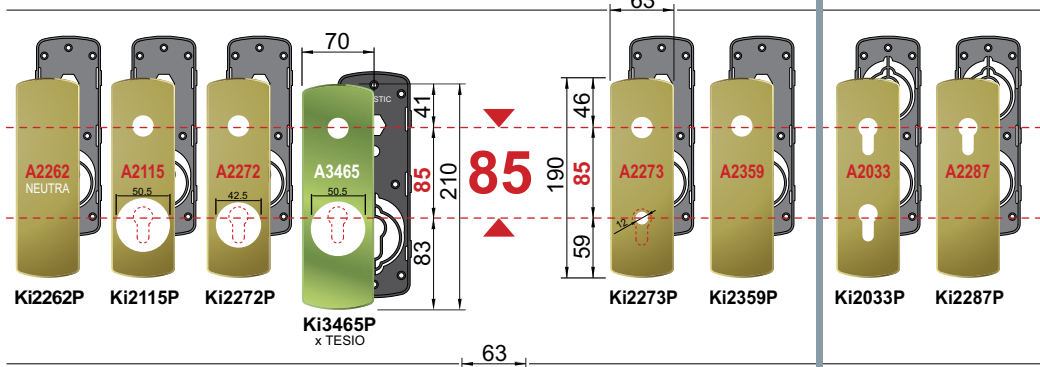
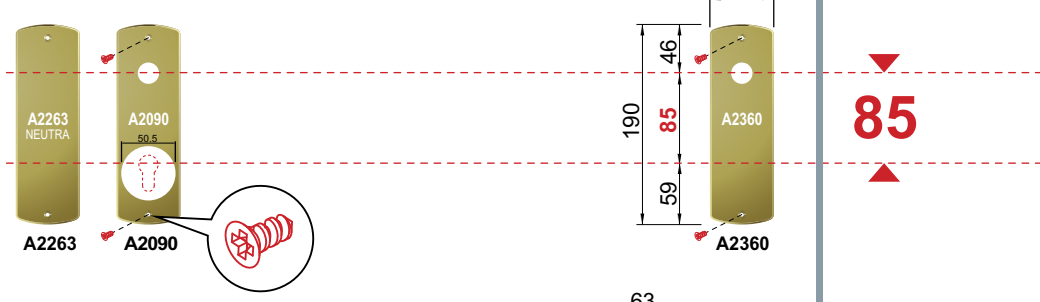
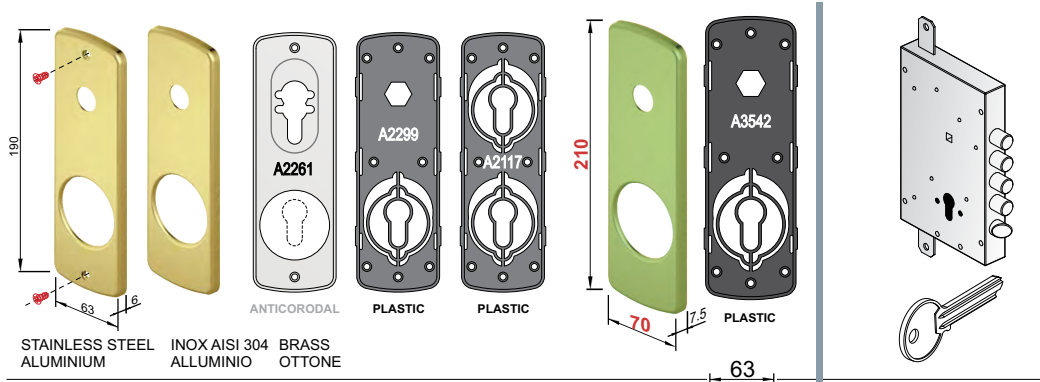

FINITURE / FINISHES

- | | | |
|------------------------------------|--------------------------------------|---|
| (C) Cromo lucido
Bright Chrome | (BS) Bronzo satinato
Satin Bronze | (II) Inox satinato
Stainless steel |
| (T) Cromo satinato
Satin Chrome | (L) Ottone lucido
Bright Brass | (9) Oro anodizzato
Anodized Gold |
| (B) Bronzo
Bronze | (2) PVD Ottone
PVD Brass | (6) Argento anodizzato
Anodized Silver |

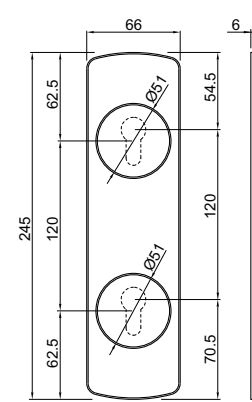
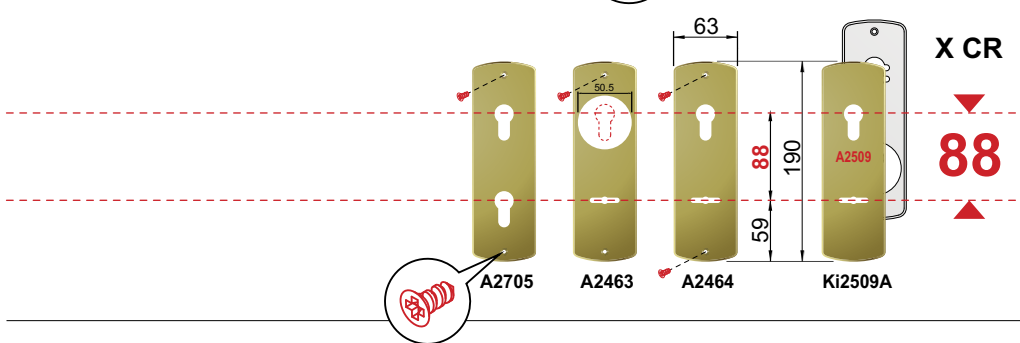
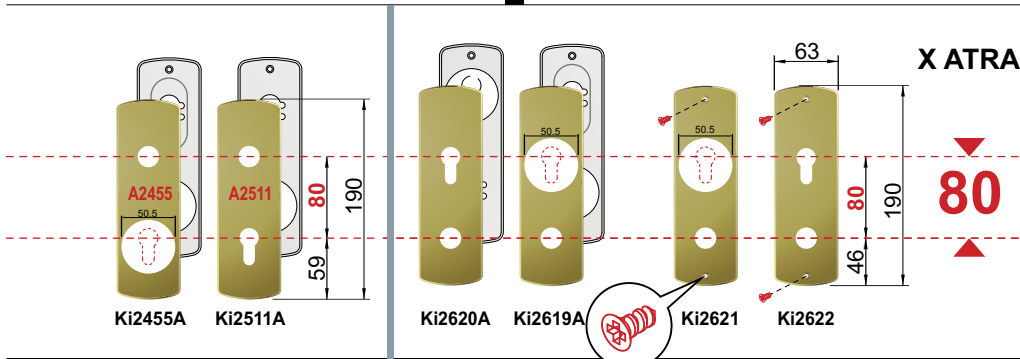
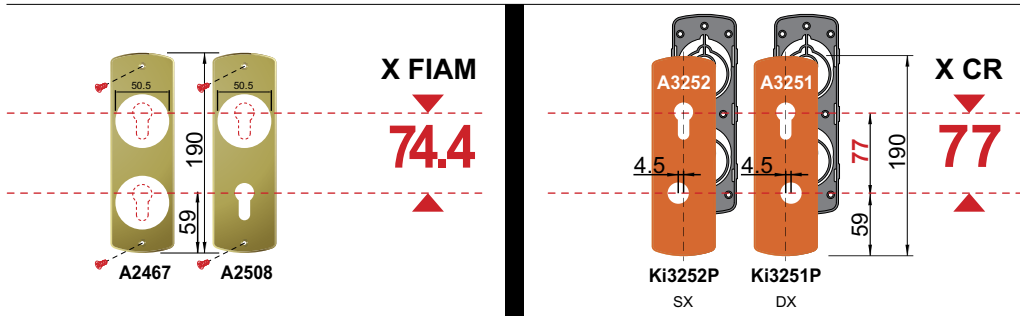
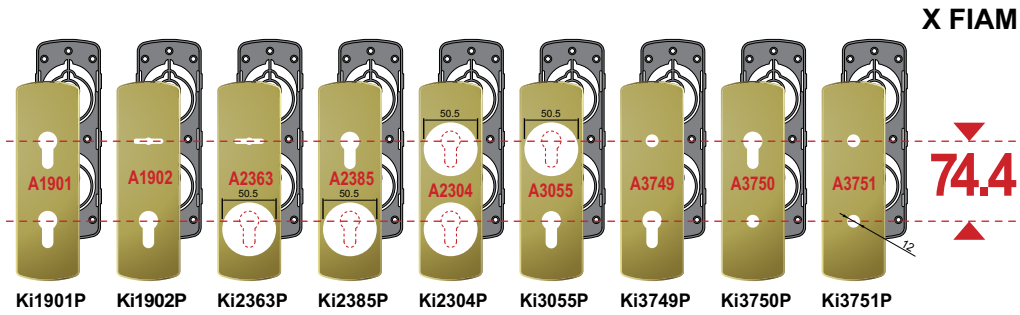
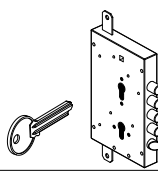

- FINITURE FINISHES
- | | | |
|------------------------------------|--------------------------------------|---|
| (C) Cromo lucido
Bright Chrome | (BS) Bronzo satinato
Satin Bronze | (II) Inox satinato
Stainless steel |
| (T) Cromo satinato
Satin Chrome | (L) Ottone lucido
Bright Brass | (9) Oro anodizzato
Anodized Gold |
| (B) Bronzo
Bronze | (2) PVD Ottone
PVD Brass | (6) Argento anodizzato
Anodized Silver |

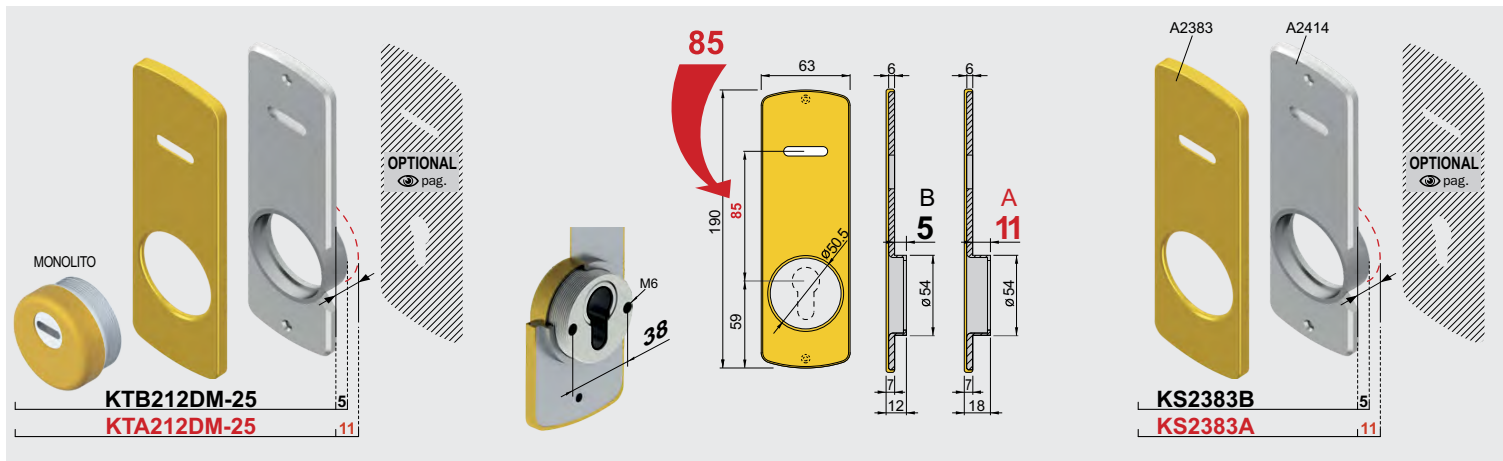
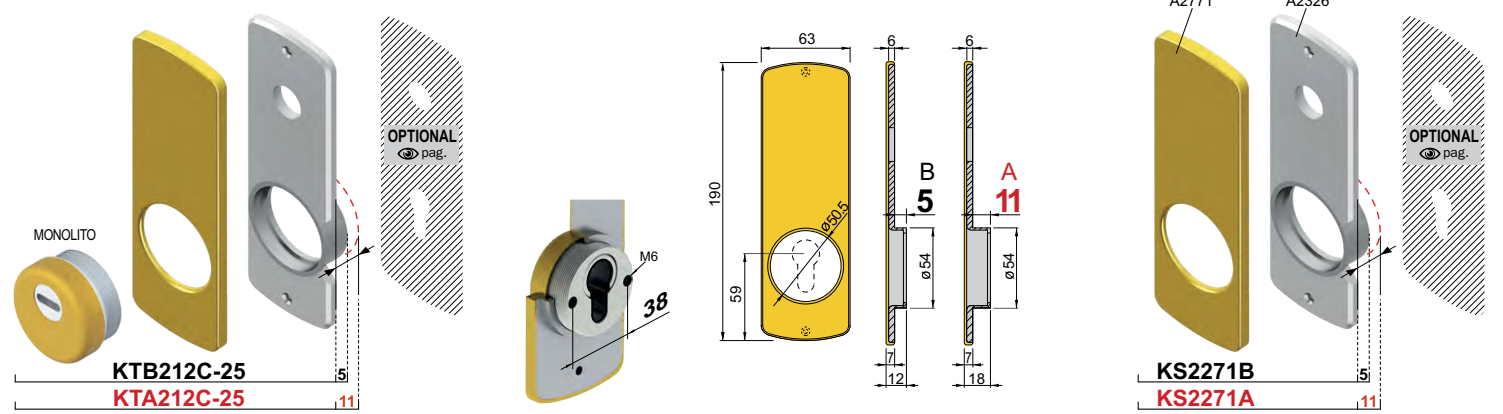
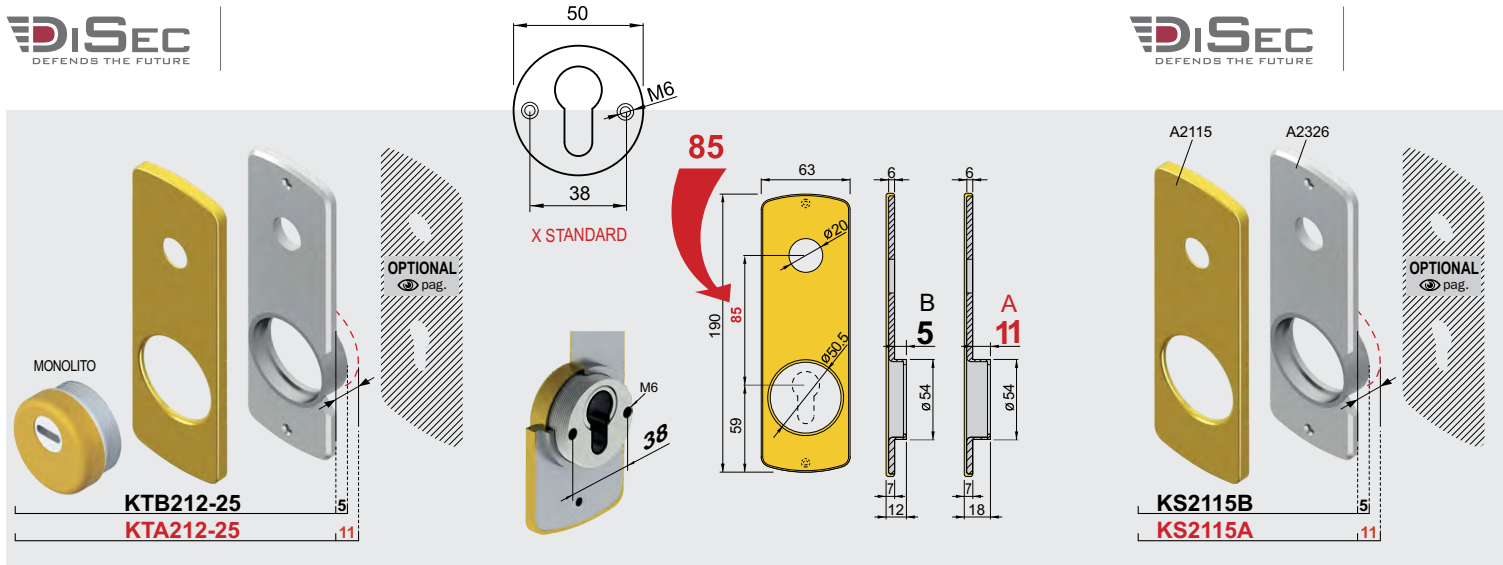

FILETTATO	Ø 50	H	M6	pag. S1	pag. D1	X OMEGA	FINITURE FINISHES
DIAMOND							
PAT. PEND.							
PAG 12		25		MA3536			<ul style="list-style-type: none"> C Cromo lucido T Cromo satinato B Bronzo Z PVD Ottonne TT Ottonne satinato BS Bronzo satinato IT Inox satinato
MONOLITO KRIPTON							
PAT. PEND.							
PAG 22		20		MA3633			<ul style="list-style-type: none"> C Cromo lucido T Cromo satinato B Bronzo Z PVD Ottonne TT Ottonne satinato BS Bronzo satinato IT Inox satinato
		25		MA3527			
		35		MA3626			
		45		MA3628			
MONOLITO							
PAT. PEND.							
PAG 32		20		MA2371			<ul style="list-style-type: none"> C Cromo lucido T Cromo satinato B Bronzo Z PVD Ottonne TT Ottonne satinato BS Bronzo satinato IT Inox satinato
		25		MA2665			
		35		MA1927			
		45		MA2702			
MAG ROUND							
PAT. PEND.							
PAG 74		20		MR12920	MR29820		<ul style="list-style-type: none"> C Cromo lucido T Cromo satinato B Bronzo Z PVD Ottonne TT Ottonne satinato BS Bronzo satinato IT Inox satinato
		25		MR12925	MR29825		
		35		MR12935			
		45		MR12945			
MRM23							
PAT. PEND.							
PAG 68		20		MR12320	MR23820		<ul style="list-style-type: none"> C Cromo lucido T Cromo satinato B Bronzo Z PVD Ottonne TT Ottonne satinato BS Bronzo satinato IT Inox satinato
		25		MR12325	MR23825		
		35		MR12335			
		45		MR12345			
MAG3G							
PAT. PEND.							
PAG 62		20		3G220	3G820		<ul style="list-style-type: none"> C Cromo lucido T Cromo satinato Z PVD Ottonne IT Inox satinato
		25		3G225			
		35		3G235			
MAG4G							
PAT. PEND.							
PAG 60		20		4G220			<ul style="list-style-type: none"> C Cromo lucido T Cromo satinato Z PVD Ottonne IT Inox satinato
		25		4G225	4G825		
		35		4G235			

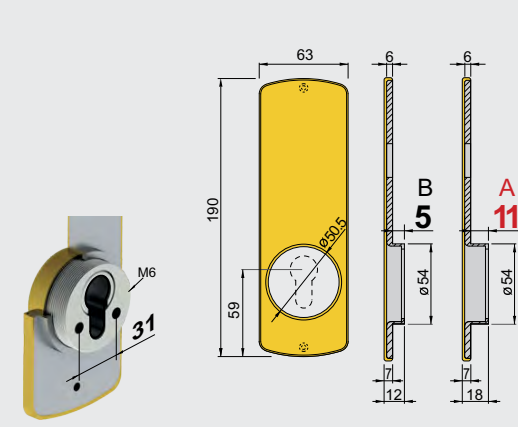
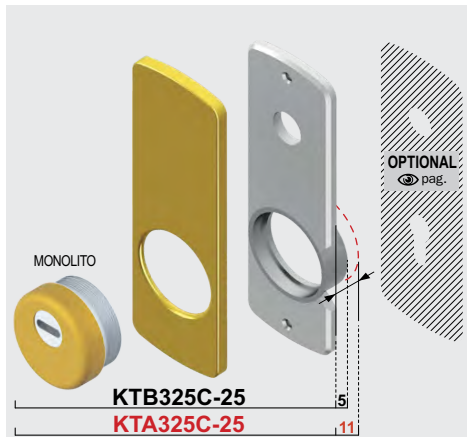
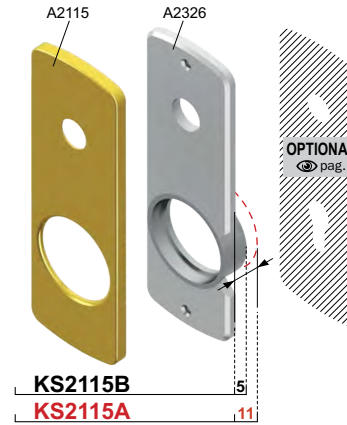
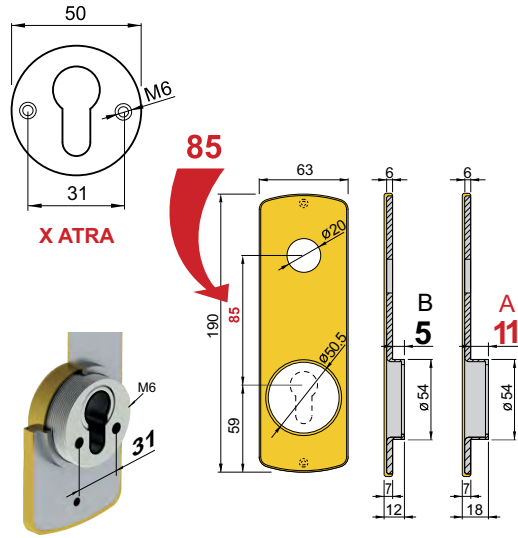
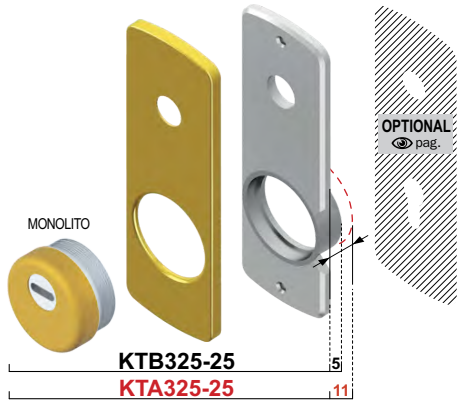

Model	Finish	Code
FILETTATO Ø 50 PAG. 12	XATRA pag. S1	MA3535
	XATRA pag. D1	
	DIAMOND	
	DIAMOND	
	DIAMOND	
	DIAMOND	
	DIAMOND	
	DIAMOND	
	DIAMOND	
	DIAMOND	
MONOLITO KRIPTON PAG. 22	Cromo lucido	MA3634
	Cromo satinato	MA3526
	Bronzo	MA3625
	PVD Ottone	MA3627
	Ottone satinato	
MONOLITO PAG. 32	Cromo lucido	MA2372
	Cromo satinato	MA2731
	Bronzo	MA1928
	PVD Ottone	
	Ottone satinato	
MAG ROUND PAG. 74	Cromo lucido	MR13920..
	Cromo satinato	MR13925..
	Bronzo	MR13935..
	PVD Ottone	
	Ottone satinato	
MRM23 PAG. 68	Cromo lucido	MR13320..
	Cromo satinato	MR13325..
	Bronzo	MR13335..
	PVD Ottone	
	Ottone satinato	
MAG3G PAG. 62	Cromo lucido	3G320..
	Cromo satinato	3G325..
	PVD Ottone	3G335..
	Ottone satinato	
	Inox satinato	
MAG4G PAG. 60	Cromo lucido	4G320..
	Cromo satinato	4G325..
	PVD Ottone	4G335..
	Ottone satinato	
	Inox satinato	

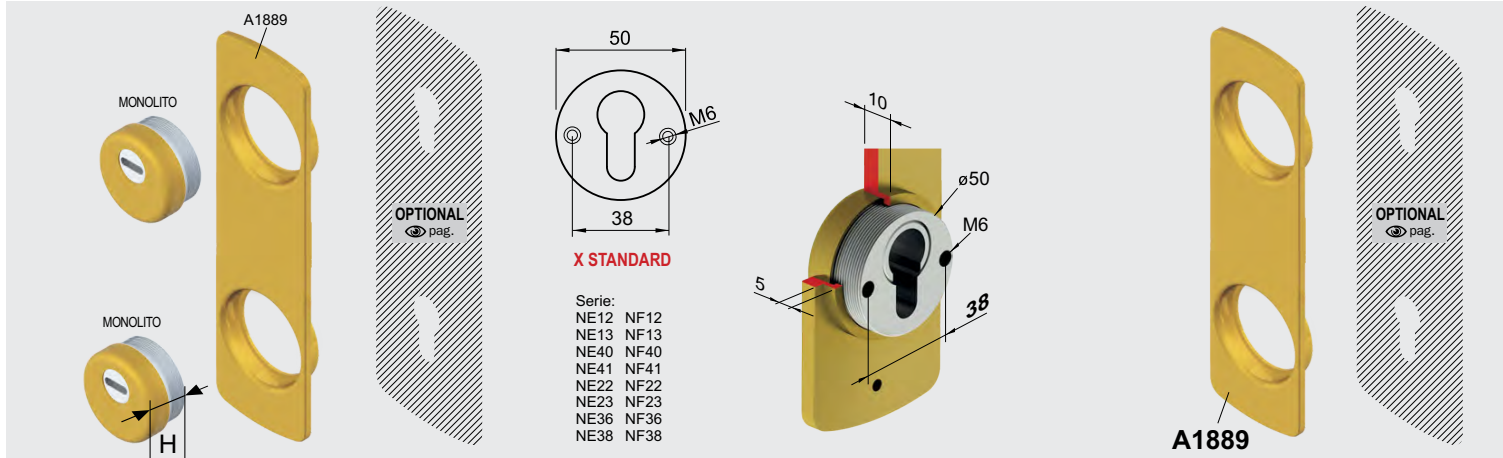

X STANDARD

Serie:
NE12 NF12
NE13 NF13
NE40 NF40
NE41 NF41
NE22 NF22
NE23 NF23
NE36 NF36
NE38 NF38

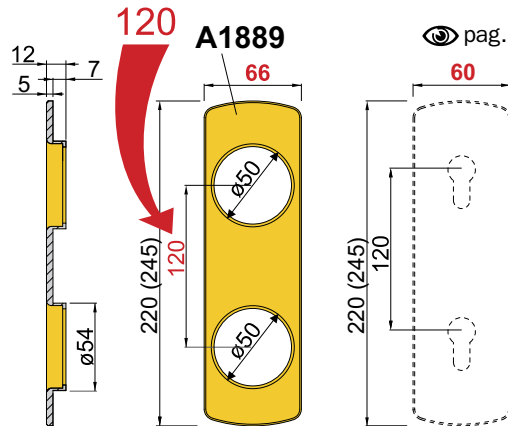
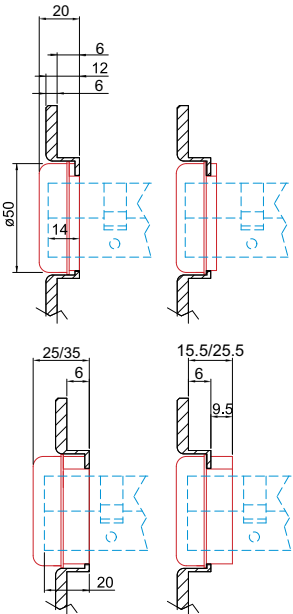

Model	Finish	Code	Code
FILETTATO Ø 50 PAG. 12		25	MA3536
MONOLITO KRIPTON PAG. 22		20	MA3633
		25	MA3527
		35	MA3626
		45	MA3628
MONOLITO PAG. 32		20	MA2371
		25	MA2665
		35	MA1927
		45	MA2702
MAG ROUND PAG. 74		20	MR12920
		25	MR12925
		35	MR12935
		45	MR12945
MRM23 PAG. 68		20	MR12320
		25	MR12325
		35	MR12335
		45	MR12345
MAG3G PAG. 62		20	3G220
		25	3G225
		35	3G235
MAG4G PAG. 60		20	4G220
		25	4G225
		35	4G235

FINITURE FINISHES

- C Cromo lucido
- T Cromo satinato
- B Bronzo
- Z PVD Ottonne
- TT Ottone satinato
- BS Bronzo satinato
- IT Inox satinato

- C Cromo lucido
- T Cromo satinato
- B Bronzo
- Z PVD Ottonne
- TT Ottone satinato
- BS Bronzo satinato
- IT Inox satinato

- C Cromo lucido
- T Cromo satinato
- B Bronzo
- Z PVD Ottonne
- TT Ottone satinato
- BS Bronzo satinato
- IT Inox satinato

- C Cromo lucido
- T Cromo satinato
- B Bronzo
- Z PVD Ottonne
- TT Ottone satinato
- BS Bronzo satinato
- IT Inox satinato

- C Cromo lucido
- T Cromo satinato
- B Bronzo
- Z PVD Ottonne
- TT Ottone satinato
- BS Bronzo satinato
- IT Inox satinato

- C Cromo lucido
- T Cromo satinato
- Z PVD Ottonne
- TT Ottone satinato
- BS Bronzo satinato
- IT Inox satinato

- C Cromo lucido
- T Cromo satinato
- Z PVD Ottonne
- TT Ottone satinato
- BS Bronzo satinato
- IT Inox satinato

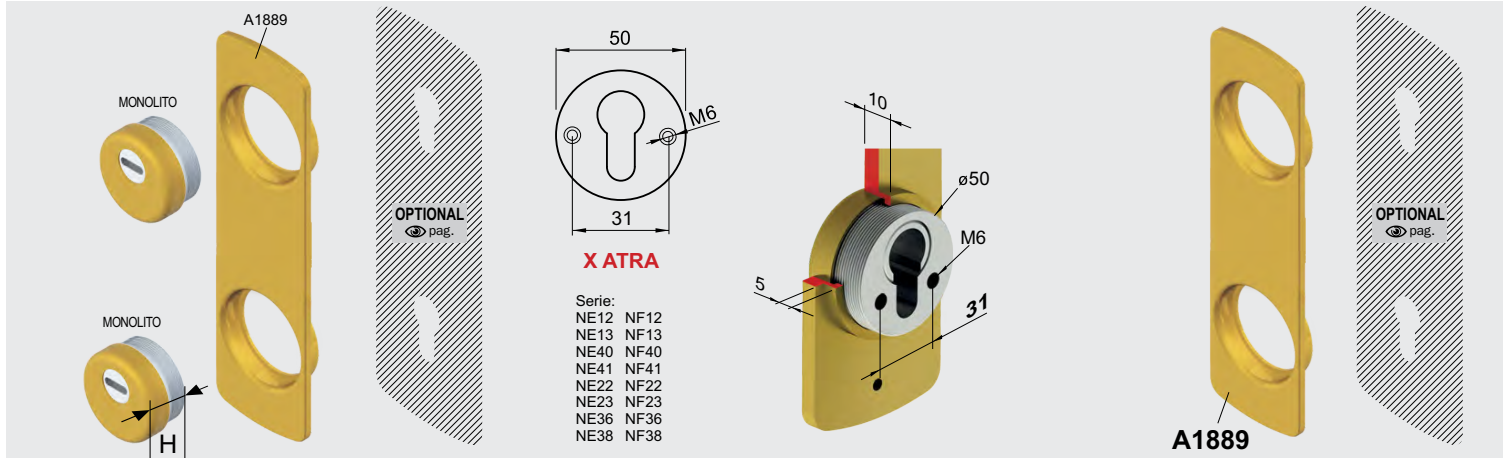

20	KT218ATR..
25	KT225ATR..
35	KT235ATR..

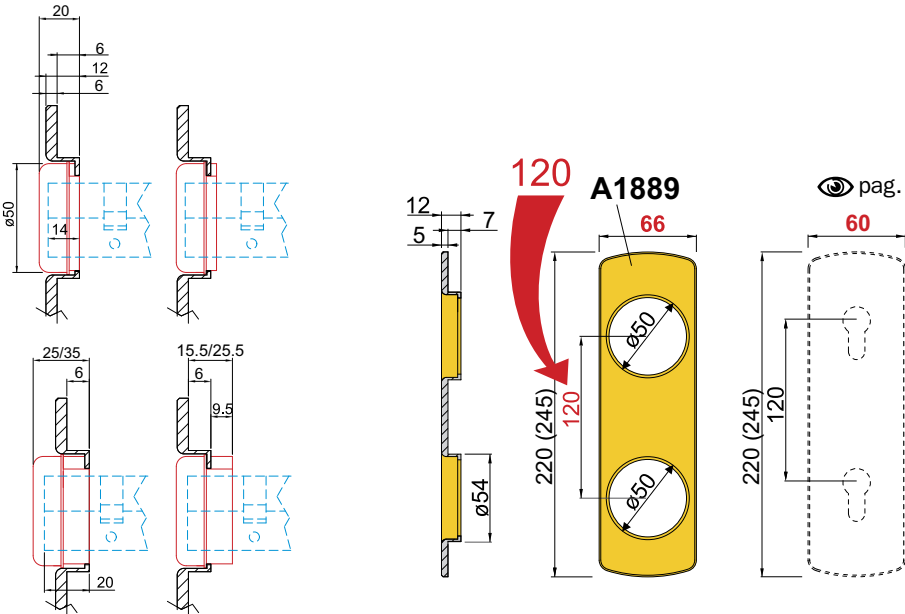

FILETTATO	Ø	X ATR A	pag.	FINITURE FINISHES
	50	H	S1 D1	C Cromo lucido T Cromo satinato B Bronzo Z PVD Ottonne TT Ottonne satinato BS Bronzo satinato IT Inox satinato
DIAMOND				
PAT. PEND.				
PAG 12		25	MA3535	C Cromo lucido T Cromo satinato B Bronzo Z PVD Ottonne TT Ottonne satinato BS Bronzo satinato IT Inox satinato
MONOLITO				
PAT. PEND.				
PAG 22		20	MA3634	C Cromo lucido T Cromo satinato B Bronzo Z PVD Ottonne TT Ottonne satinato BS Bronzo satinato IT Inox satinato
		25	MA3526	
		35	MA3625	
		45	MA3627	
MONOLITO				
PAT. PEND.				
PAG 32		20	MA2372	C Cromo lucido T Cromo satinato B Bronzo Z PVD Ottonne TT Ottonne satinato BS Bronzo satinato IT Inox satinato
		25	MA2731	
		35	MA1928	
		45		
MAG ROUND				
PAT. PEND.				
PAG 74		20	MR13920..	C Cromo lucido T Cromo satinato B Bronzo Z PVD Ottonne TT Ottonne satinato BS Bronzo satinato IT Inox satinato
		25	MR13925..	
		35	MR13935..	
		45		
MRM23				
PAT. PEND.				
PAG 68		20	MR13320..	C Cromo lucido T Cromo satinato B Bronzo Z PVD Ottonne TT Ottonne satinato BS Bronzo satinato IT Inox satinato
		25	MR13325..	
		35	MR13335..	
		45		
MAG3G				
PAT. PEND.				
PAG 62		20	3G320..	C Cromo lucido T Cromo satinato B Bronzo Z PVD Ottonne TT Ottonne satinato
		25	3G325..	
		35	3G335..	
MAG4G				
PAT. PEND.				
PAG 60		20	4G320..	C Cromo lucido T Cromo satinato B Bronzo Z PVD Ottonne TT Ottonne satinato
		25	4G325..	
		35	4G335..	

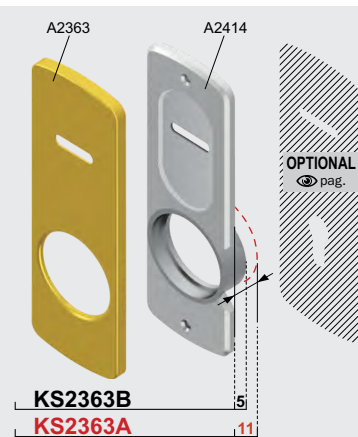
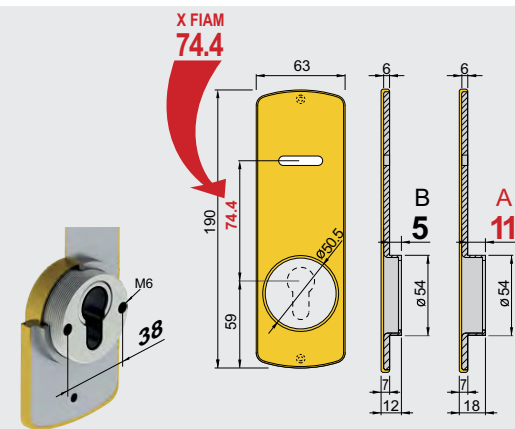
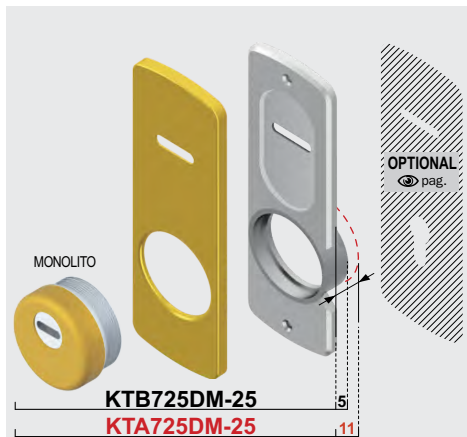
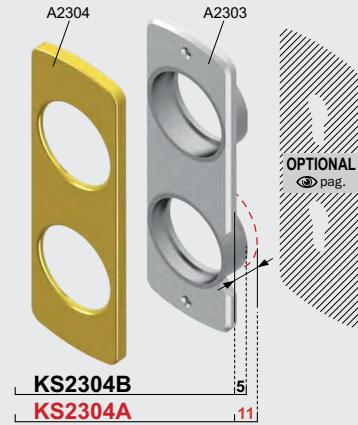
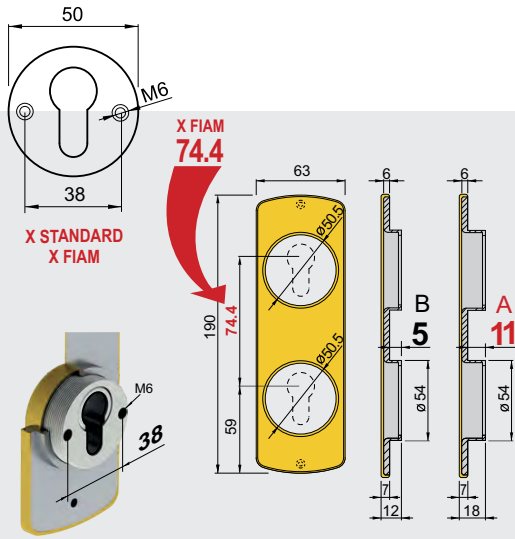
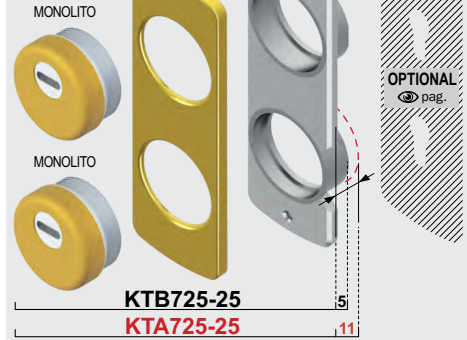

FILETTATO	Ø	H	pag.	X OMEGA	FINITURE FINISHES	
DIAMOND	50	25	PAT. PEND. PAG 12	MA3536	C Cromo lucido T Bright Chrome C Cromo satinato T Satin Chrome B Bronzo B Bronze 2 PVD Otton 2 PVD Brass TT Otton satinato TT Satin Brass BS Bronzo satinato BS Satin Bronze IT Inox satinato IT Stainless steel	
MONOLITO KRIPTON		20 25 35 45	PAT. PEND. PAG 22	MA3633 MA3527 MA3626 MA3628	C Cromo lucido T Bright Chrome C Cromo satinato T Satin Chrome B Bronzo B Bronze 2 PVD Otton 2 PVD Brass TT Otton satinato TT Satin Brass BS Bronzo satinato BS Satin Bronze IT Inox satinato IT Stainless steel	
MONOLITO		20 25 35 45	PAT. PEND. PAG 32	MA2371 MA2665 MA1927 MA2702	C Cromo lucido T Bright Chrome C Cromo satinato T Satin Chrome B Bronzo B Bronze 2 PVD Otton 2 PVD Brass TT Otton satinato TT Satin Brass BS Bronzo satinato BS Satin Bronze IT Inox satinato IT Stainless steel	
MAG ROUND		20 25 35 45	PAT. PEND. PAG 74	MR12920 MR12925 MR12935 MR12945	MR29820 MR29825	C Cromo lucido T Bright Chrome C Cromo satinato T Satin Chrome B Bronzo B Bronze 2 PVD Otton 2 PVD Brass TT Otton satinato TT Satin Brass BS Bronzo satinato BS Satin Bronze IT Inox satinato IT Stainless steel
MRM23		20 25 35 45	PAT. PEND. PAG 68	MR12320 MR12325 MR12335 MR12345	MR23820 MR23825	C Cromo lucido T Bright Chrome C Cromo satinato T Satin Chrome B Bronzo B Bronze 2 PVD Otton 2 PVD Brass TT Otton satinato TT Satin Brass BS Bronzo satinato BS Satin Bronze IT Inox satinato IT Stainless steel
MAG3G		20 25 35	PAT. PEND. PAG 62	3G220 3G225 3G235	3G820	C Cromo lucido T Bright Chrome C Cromo satinato T Satin Chrome B Bronzo B Bronze 2 PVD Otton 2 PVD Brass TT Otton satinato TT Satin Brass BS Bronzo satinato BS Satin Bronze IT Inox satinato IT Stainless steel
MAG4G		20 25 35	PAT. PEND. PAG 60	4G220 4G225 4G235	4G825	C Cromo lucido T Bright Chrome C Cromo satinato T Satin Chrome B Bronzo B Bronze 2 PVD Otton 2 PVD Brass TT Otton satinato TT Satin Brass BS Bronzo satinato BS Satin Bronze IT Inox satinato IT Stainless steel

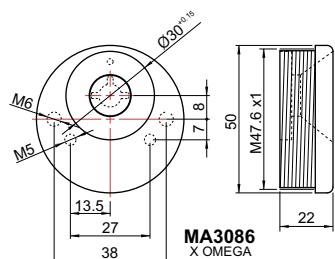

X Ω

MA3086
X OMEGA

A2134

KS2115A
KS2115B

ACCIAIO
STEEL

A2326

AS2326B

AS2326A

A2301
A2302

MA3086

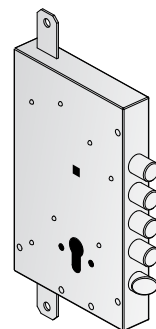

X MOTTURA / CR

KS2440A
KS2440B

ACCIAIO
STEEL

MONOLITO

MONOLITO

AS2439B

AS2439A

5
11

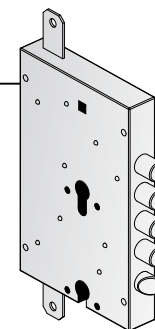

KTB10800

KTA10800

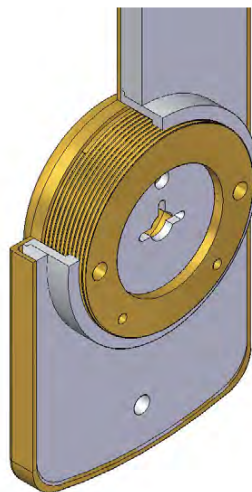
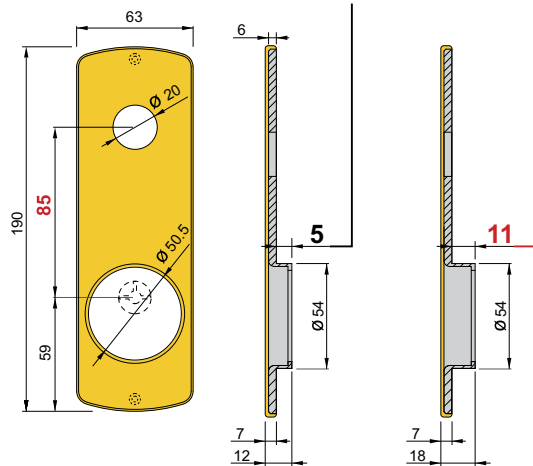

KTB425-25..

KTA425-25..

X MOTTURA / CR

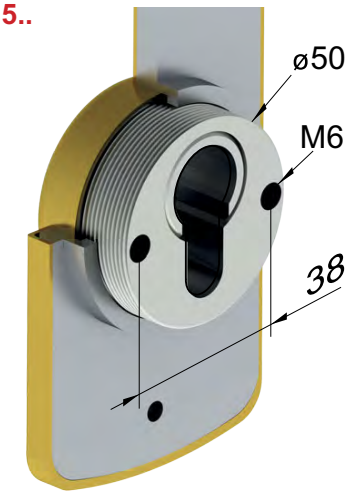
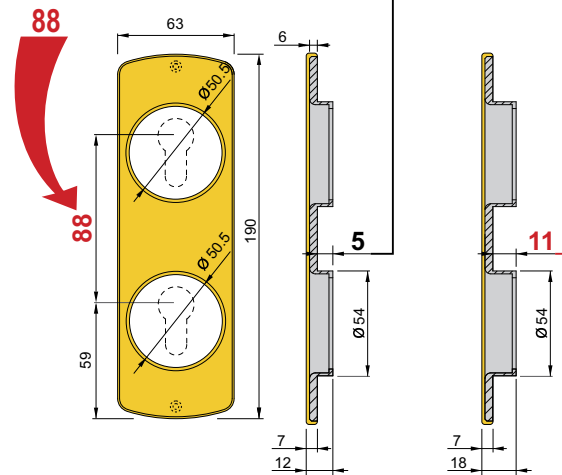

FINITURE / FINISHES

- C** Cromo lucido / Bright Chrome
- T** Cromo satinato / Satin Chrome
- B** Bronzo / Bronze
- 12** Ottone Zapponato / Satin Brass
- IT** Inox satinato / Stainless steel
- 2** PVD Ottone / PVD Brass
- BS** Bronzo satinato / Satin Bronze

FINITURE / FINISHES

- C** Cromo lucido / Bright Chrome
- T** Cromo satinato / Satin Chrome
- B** Bronzo / Bronze
- 12** Ottone Zapponato / Satin Brass
- IT** Inox satinato / Stainless steel
- 2** PVD Ottone / PVD Brass
- BS** Bronzo satinato / Satin Bronze

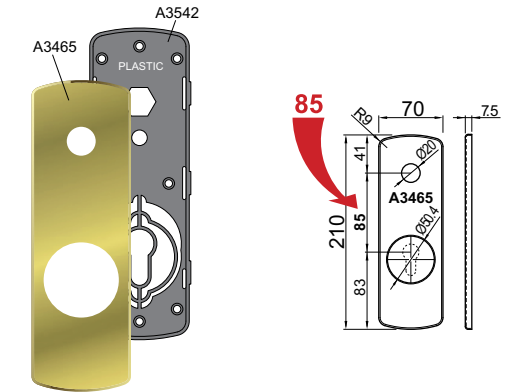
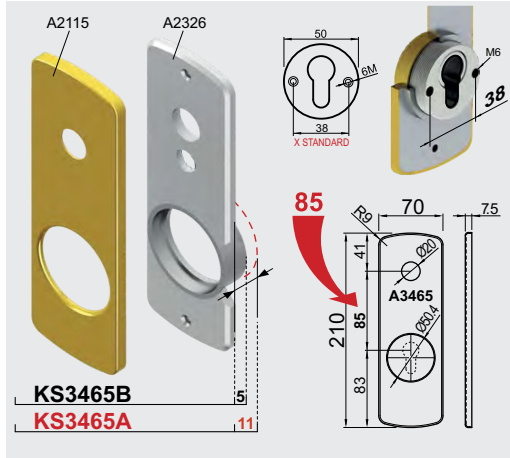

Ki3465P X TESIO

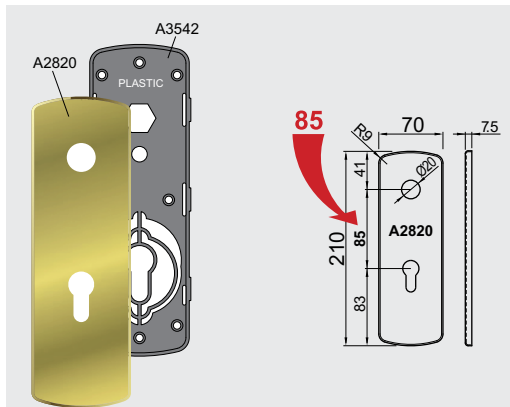

Ki2820P X TESIO

FILETTATO	Ø	H	pag.	FINITURE / FINISHES
	50	25	S1	D1
DIAMOND				
PAT. PEND.				
PAG 12		25	MA3536	C Cromo lucido T Cromo satinato B Bronzo 2 PVD Ottonne TT Ottonne satinato BS Bronzo satinato IT Inox satinato
MONOLITO KRIPTON				
PAT. PEND.				
PAG 22		20	MA3633	C Cromo lucido T Cromo satinato B Bronzo 2 PVD Ottonne TT Ottonne satinato BS Bronzo satinato IT Inox satinato
		25	MA3527	
		35	MA3626	
		45	MA3628	
MONOLITO				
PAT. PEND.				
PAG 32		20	MA2371	C Cromo lucido T Cromo satinato B Bronzo 2 PVD Ottonne TT Ottonne satinato BS Bronzo satinato IT Inox satinato
		25	MA2665	
		35	MA1927	
		45	MA2702	
MAG ROUND				
PAT. PEND.				
PAG 74		20	MR12920	C Cromo lucido T Cromo satinato B Bronzo 2 PVD Ottonne TT Ottonne satinato BS Bronzo satinato IT Inox satinato
		25	MR12925	
		35	MR12935	
		45	MR12945	
MRM23				
PAT. PEND.				
PAG 68		20	MR12320	C Cromo lucido T Cromo satinato B Bronzo 2 PVD Ottonne TT Ottonne satinato BS Bronzo satinato IT Inox satinato
		25	MR12325	
		35	MR12335	
		45	MR12345	
MAG3G				
PAT. PEND.				
PAG 62		20	3G220	C Cromo lucido T Cromo satinato B Bronzo 2 PVD Ottonne TT Ottonne satinato BS Bronzo satinato IT Inox satinato
		25	3G225	
		35	3G235	
MAG4G				
PAT. PEND.				
PAG 60		20	4G220	C Cromo lucido T Cromo satinato B Bronzo 2 PVD Ottonne TT Ottonne satinato BS Bronzo satinato IT Inox satinato
		25	4G225	
		35	4G235	



MONOLITO KT2108-25D1 X OMEGA

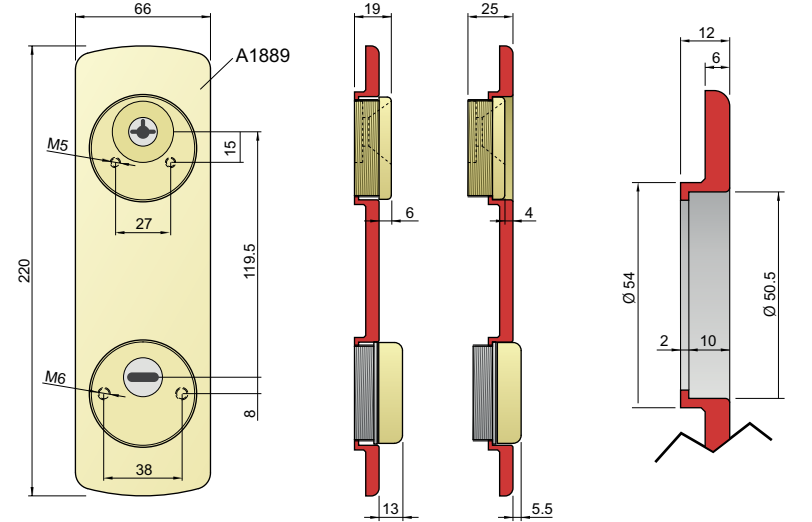

FINITURE / FINISHES

- T Cromo satinato
Satin Chrome
- 2 PVD Ottonne
PVD Brass
- B Bronzo
Bronze

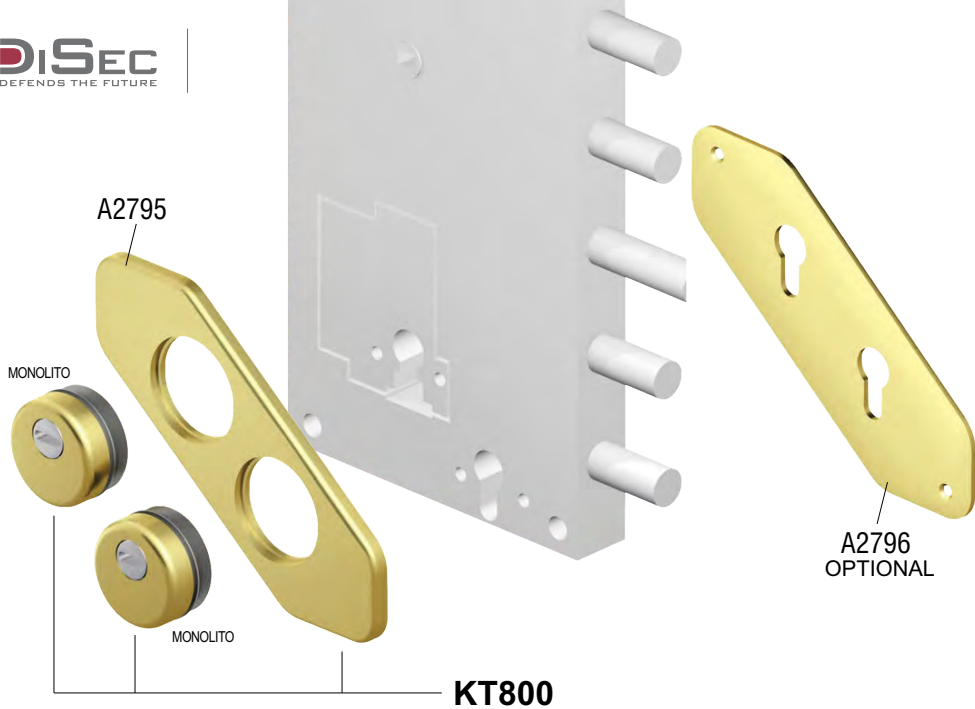

KT80

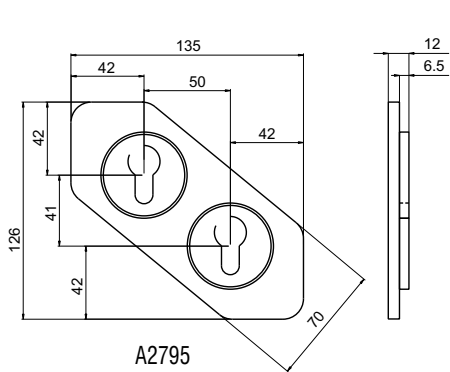

A2795

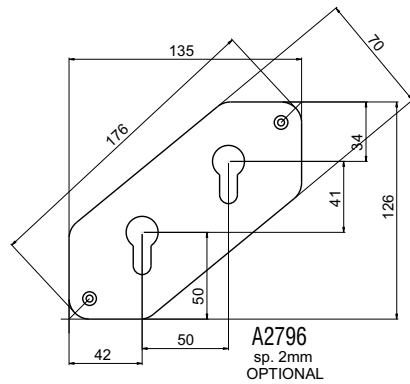

A2796
sp. 2mm
OPTIONAL

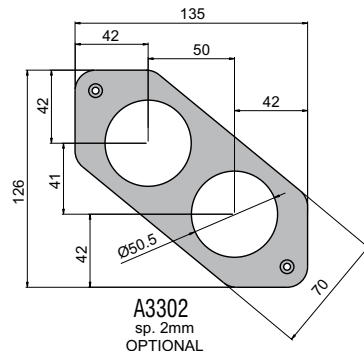

A3302
sp. 2mm
OPTIONAL

FINITURE / FINISHES

- C** Cromo lucido
Bright Chrome
- T** Cromo satinato
Satin Chrome
- IT** Inox satinato
Stainless steel
- B** Bronzo
Bronze
- Z** PVD Ottono
PVD Brass
- BS** Bronzo satinato
Satin Bronze
- AZ** Ottono Zapponato
Satin Brass

x FERBONA



A3800

A3805

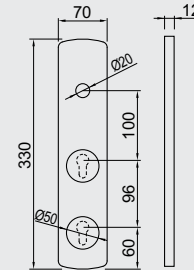

A3801

A3806

A3807

A3808

**FINITURE
FINISHES**

- C** Cromo lucido
Bright Chrome
- T** Cromo satinato
Satin Chrome
- B** Bronzo
Bronze
- Z** PVD Ottono
PVD Brass
- 9** Oro anodizzato
Anodized Gold
- 6** Argento anodizzato
Anodized Silver

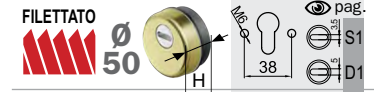
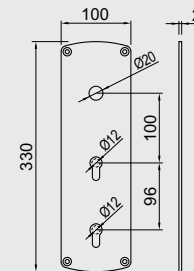

FILETTATO

Ø 50

PAG. PEND.

PAG 12



25

MA3536

**MONOLITO
KRYPTON**

PAG. PEND.

PAG 22



20

MA3633

25

MA3527

35

MA3626

45

MA3628

MONOLITO

PAG. PEND.

PAG 32



20

MA2371

25

MA2665

35

MA1927

45

MA2702

MAG ROUND

PAG. PEND.

PAG 74



20

MR12920

25

MR12925

35

MR12935

45

MR12945

MRM23

PAG. PEND.

PAG 68



20

MR12320

25

MR12325

35

MR12335

45

MR12345

MAG3G

PAG. PEND.

PAG 62



20

3G220

25

3G225

35

3G235

MAG4G

PAG. PEND.

PAG 60



20

4G220

25

4G225

35

4G235

**FINITURE
FINISHES**

- C** Cromo lucido
Bright Chrome
- T** Cromo satinato
Satin Chrome
- B** Bronzo
Bronze
- Z** PVD Ottono
PVD Brass
- IT** Ottono satinato
Satin Brass
- BS** Bronzo satinato
Satin Bronze
- IT** Inox satinato
Stainless steel

- C** Cromo lucido
Bright Chrome
- T** Cromo satinato
Satin Chrome
- B** Bronzo
Bronze
- Z** PVD Ottono
PVD Brass
- IT** Ottono satinato
Satin Brass
- BS** Bronzo satinato
Satin Bronze
- IT** Inox satinato
Stainless steel

- C** Cromo lucido
Bright Chrome
- T** Cromo satinato
Satin Chrome
- B** Bronzo
Bronze
- Z** PVD Ottono
PVD Brass
- IT** Ottono satinato
Satin Brass
- BS** Bronzo satinato
Satin Bronze
- IT** Inox satinato
Stainless steel

- C** Cromo lucido
Bright Chrome
- T** Cromo satinato
Satin Chrome
- B** Bronzo
Bronze
- Z** PVD Ottono
PVD Brass
- IT** Ottono satinato
Satin Brass
- BS** Bronzo satinato
Satin Bronze
- IT** Inox satinato
Stainless steel

- C** Cromo lucido
Bright Chrome
- T** Cromo satinato
Satin Chrome
- B** Bronzo
Bronze
- Z** PVD Ottono
PVD Brass
- IT** Ottono satinato
Satin Brass
- BS** Bronzo satinato
Satin Bronze
- IT** Inox satinato
Stainless steel

- C** Cromo lucido
Bright Chrome
- T** Cromo satinato
Satin Chrome
- B** Bronzo
Bronze
- Z** PVD Ottono
PVD Brass
- IT** Ottono satinato
Satin Brass
- BS** Bronzo satinato
Satin Bronze
- IT** Inox satinato
Stainless steel

- C** Cromo lucido
Bright Chrome
- T** Cromo satinato
Satin Chrome
- Z** PVD Ottono
PVD Brass
- IT** Inox satinato
Stainless steel

X STANDARD

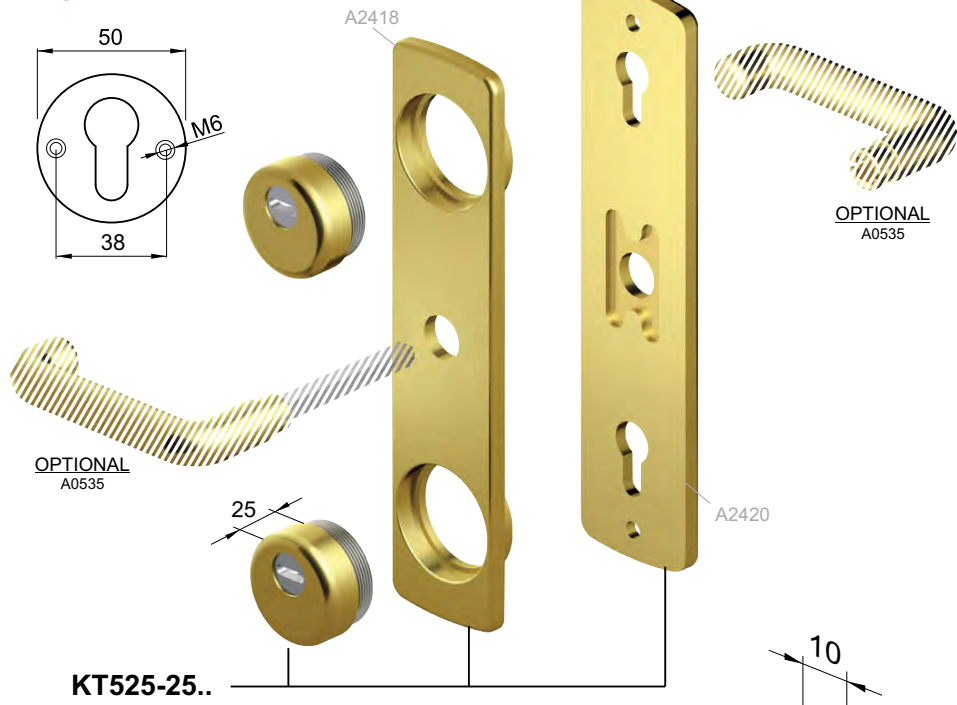

X STANDARD

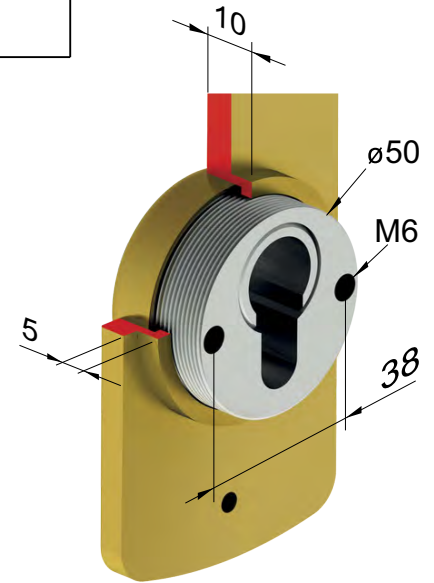
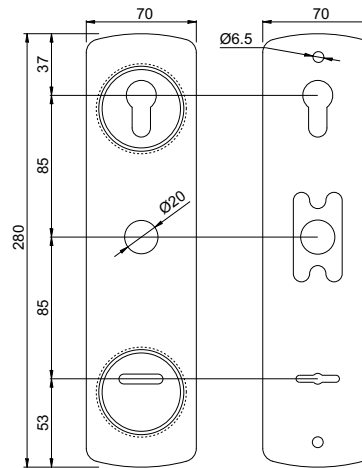
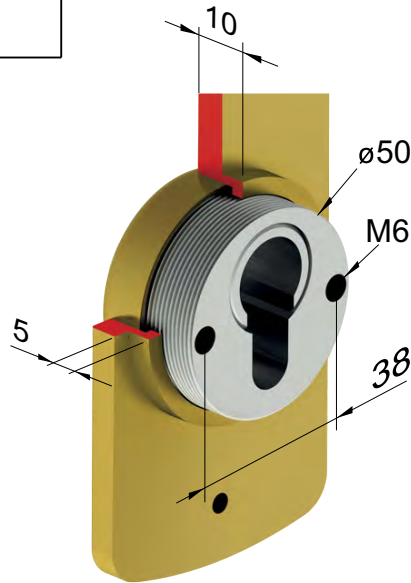
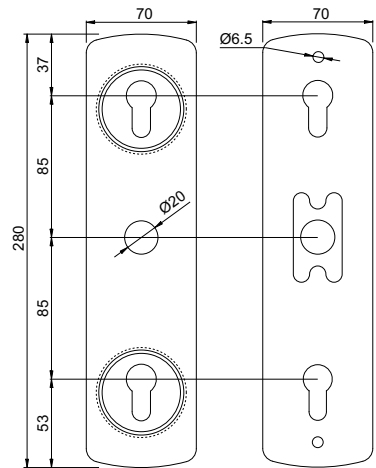
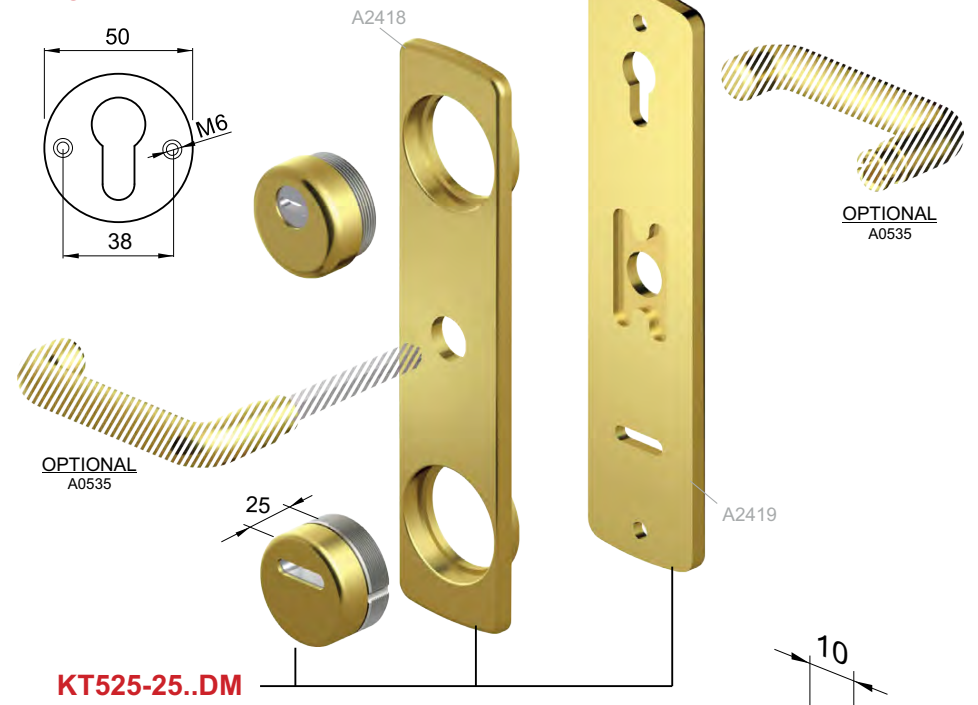

FINITURE / FINISHES

- T Cromo satinato / Satin Chrome
- 2 PVD Ottone / PVD Brass
- B Bronzo / Bronze

FINITURE / FINISHES

- T Cromo satinato / Satin Chrome
- 2 PVD Ottone / PVD Brass
- B Bronzo / Bronze

X FIAM 868

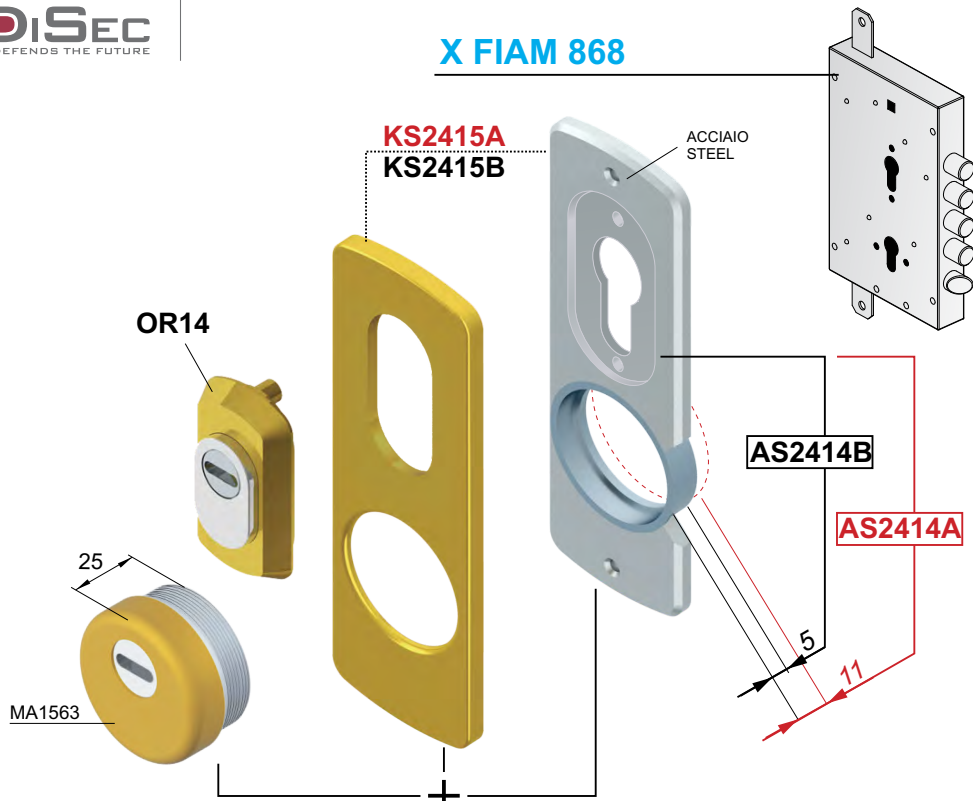

X FIAM 868

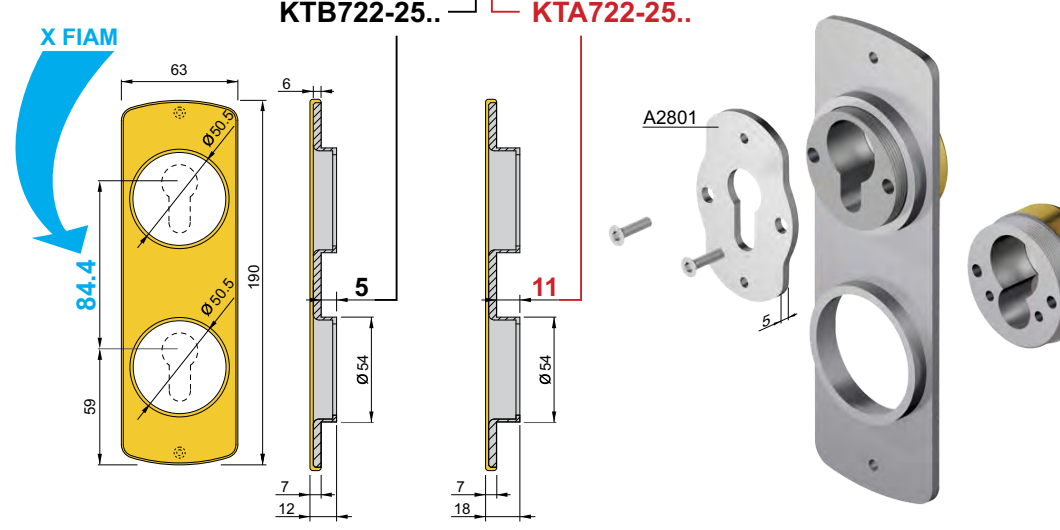
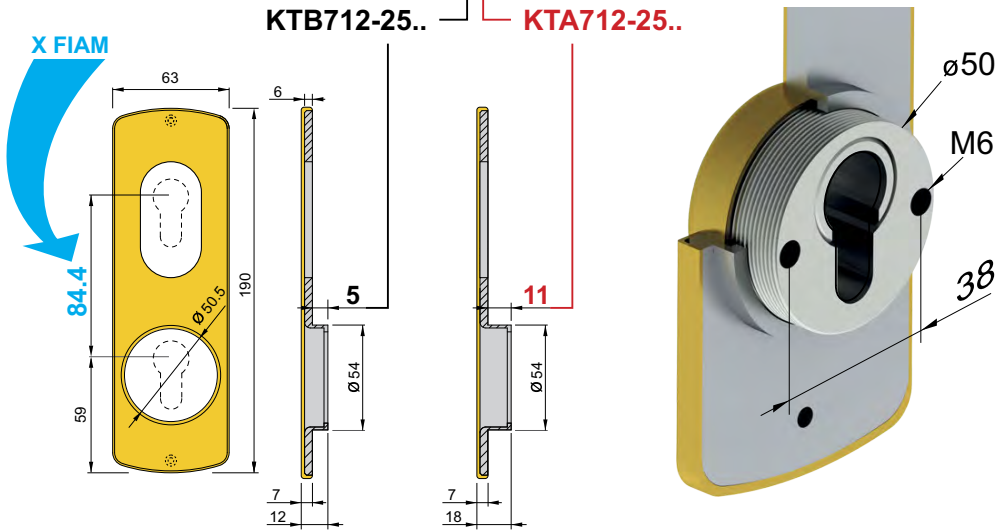
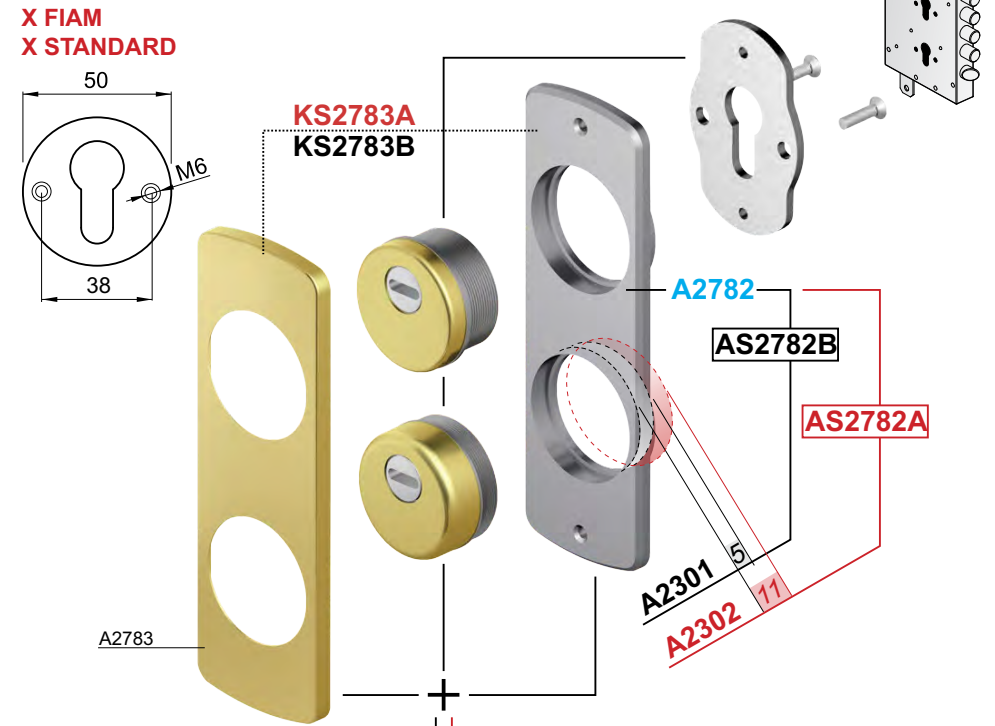

FINITURE / FINISHES

- C Cromo lucido / Bright Chrome
- T Cromo satinato / Satin Chrome
- B Bronzo / Bronze
- Z Ottone Zapponato / Satin Brass
- IT Inox satinato / Stainless steel
- 2 PVD Ottone / PVD Brass
- BS Bronzo satinato / Satin Bronze

FINITURE / FINISHES

- C Cromo lucido / Bright Chrome
- T Cromo satinato / Satin Chrome
- B Bronzo / Bronze
- Z Ottone Zapponato / Satin Brass
- IT Inox satinato / Stainless steel
- 2 PVD Ottone / PVD Brass
- BS Bronzo satinato / Satin Bronze

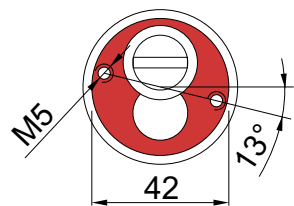

x CR 2155PE

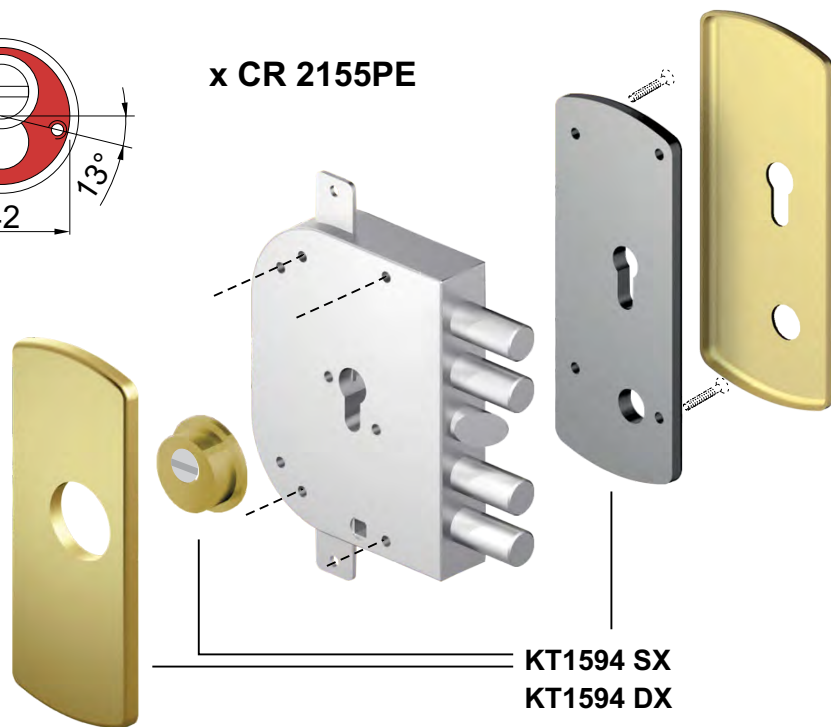

KT1594 SX
KT1594 DX

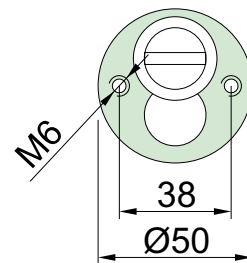

x CR SERIE 21 PE N
x MOTTURA

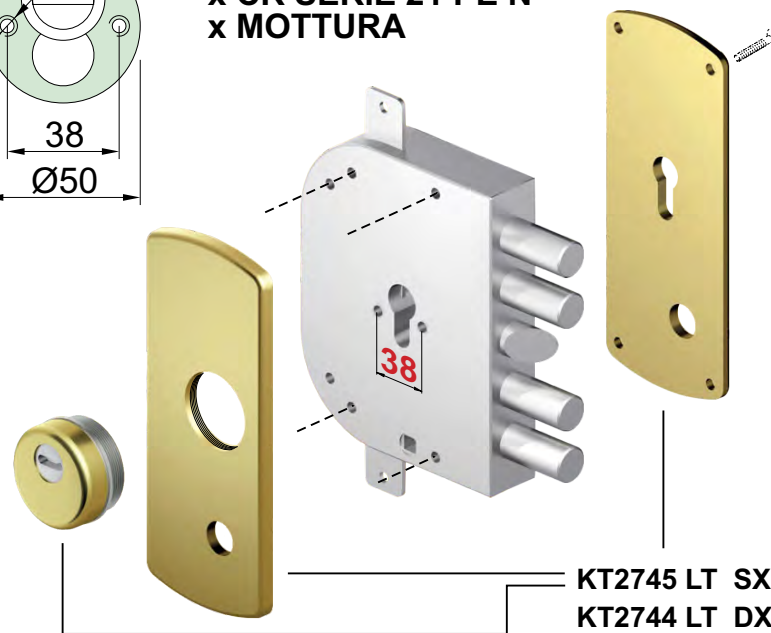

KT2745 LT SX MT
KT2744 LT DX MT

DX

SX

DX

SX

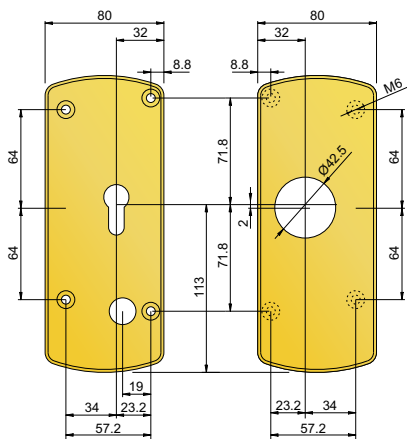

dx CR 2155PE
sp 6mm A1597

dx CR 2155PE
sp 8mm A1596

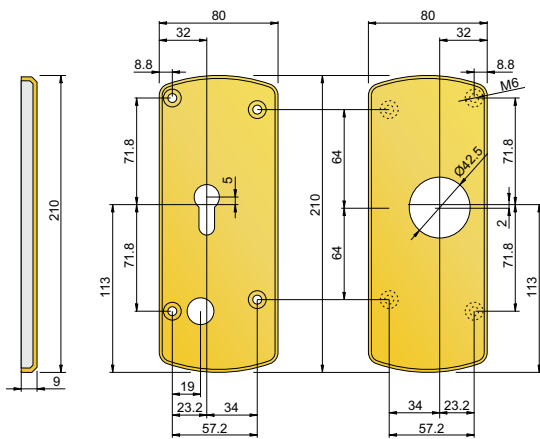

sx CR 2155PE
sp 6mm A1595

sx CR 2155PE
sp 8mm A1594

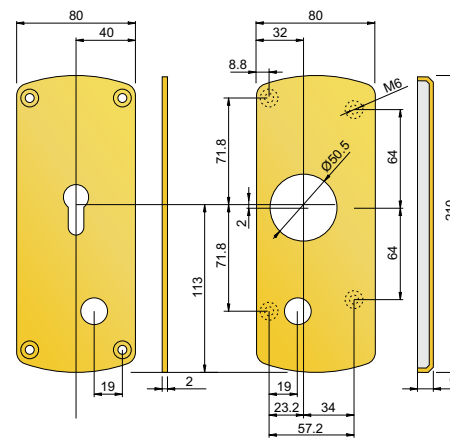

dx CR 21 PE N
A2750 DX

dx CR 21 PE N
Ki2744

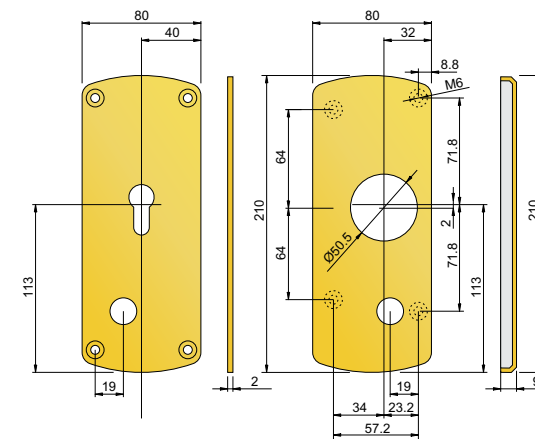

sx CR 21 PE N
A2750 SX

sx CR 21 PE N
Ki2745

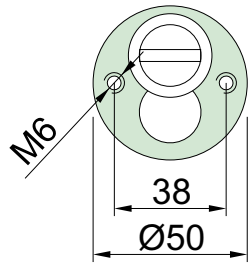

x CR SERIE 21 PE N
x MOTTURA

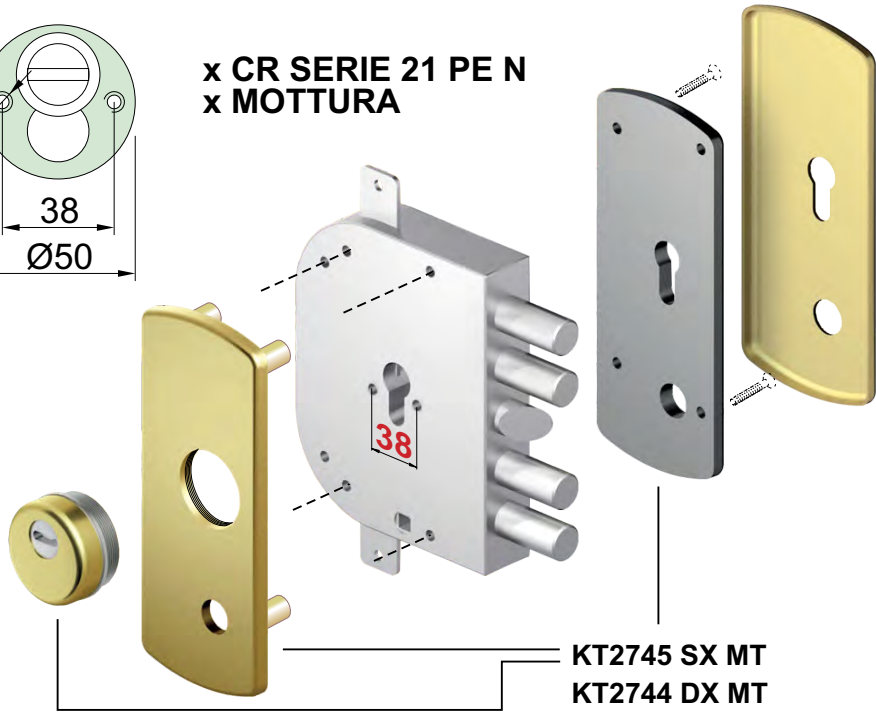

KT2745 SX MT
KT2744 DX MT

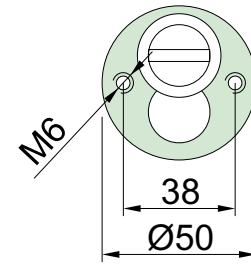

x CR SERIE 21 PE N
x MOTTURA

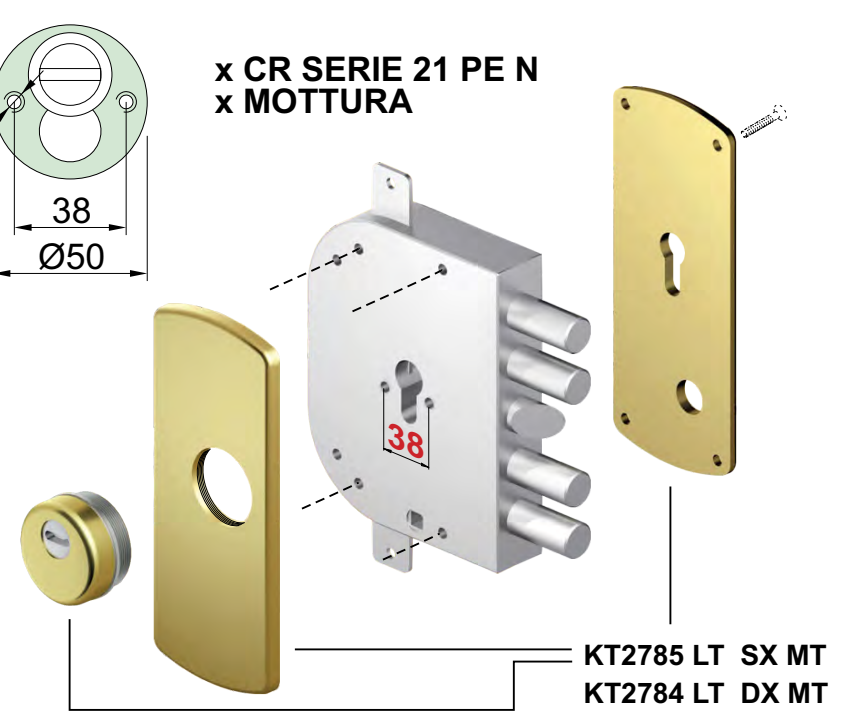

KT2785 LT SX MT
KT2784 LT DX MT

DX

SX

DX

SX

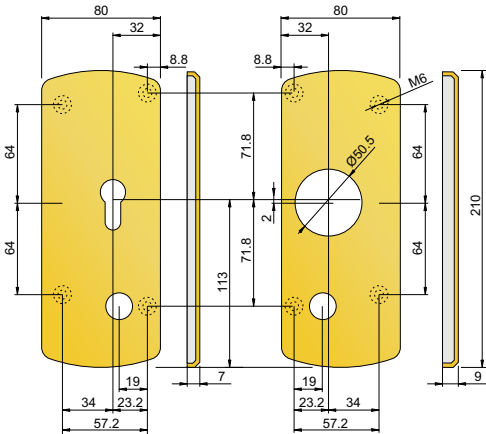

dx CR 21 PE N
Ki2774

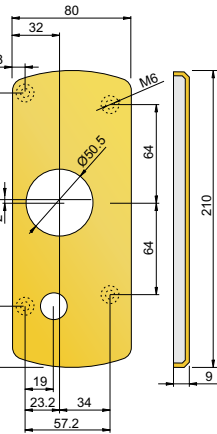

dx CR 21 PE N
Ki2744

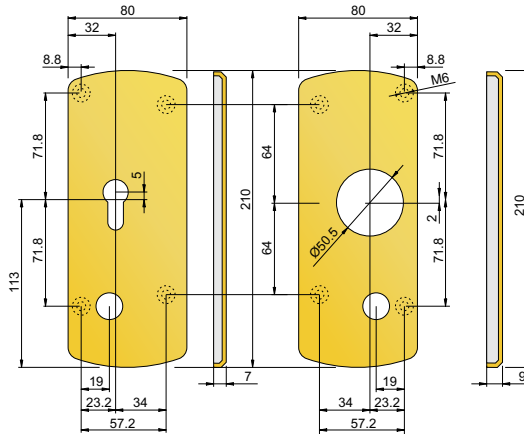

sx CR 21 PE N
Ki2775

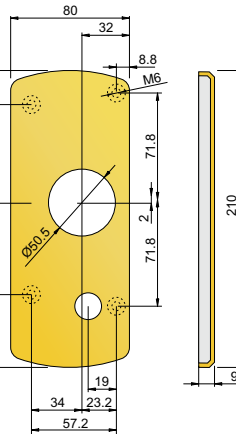

sx CR 21 PE N
Ki2745

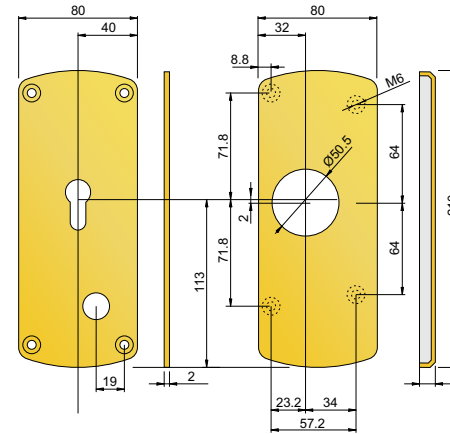

dx CR 21 PE N
A2750 DX

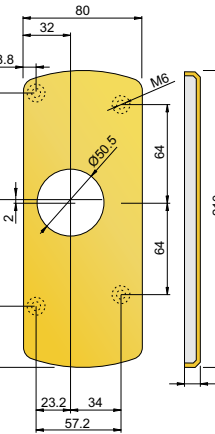

dx CR 21 PE N
Ki2784

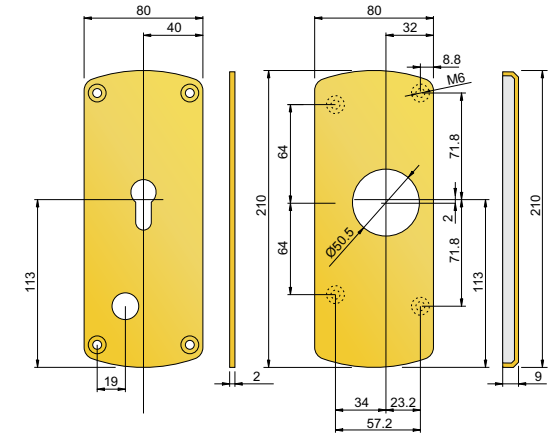

sx CR 21 PE N
A2750 SX

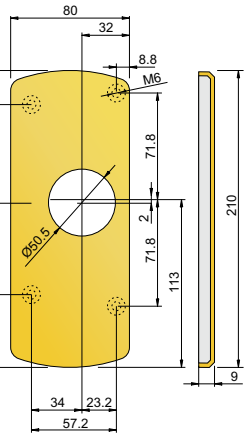

sx CR 21 PE N
Ki2785

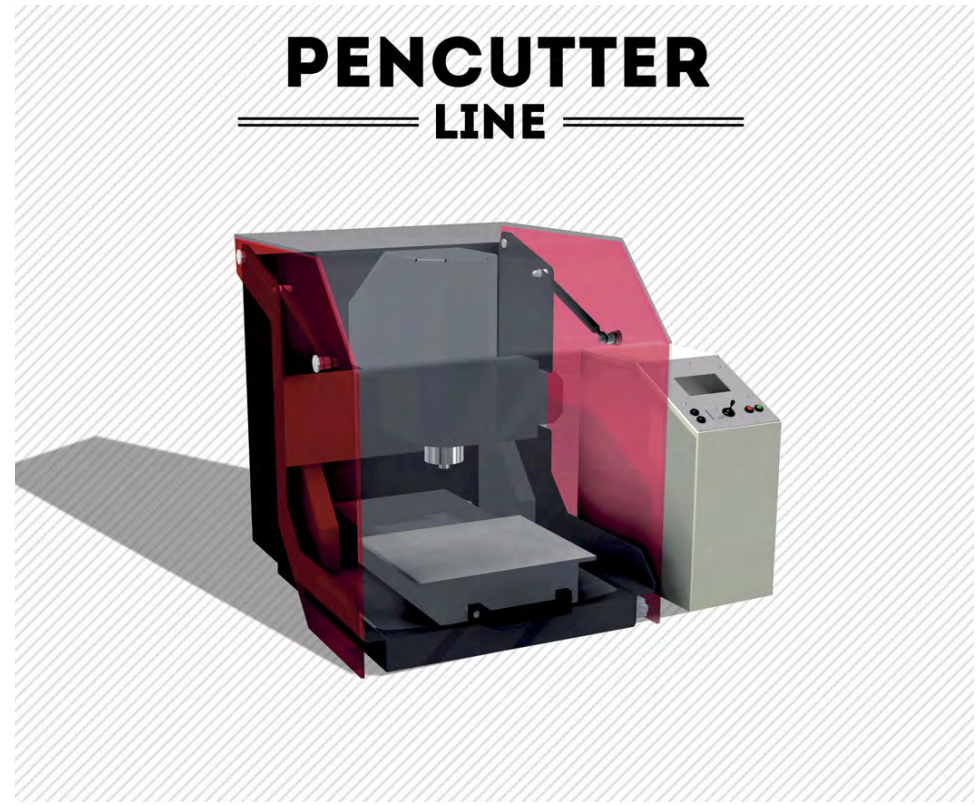
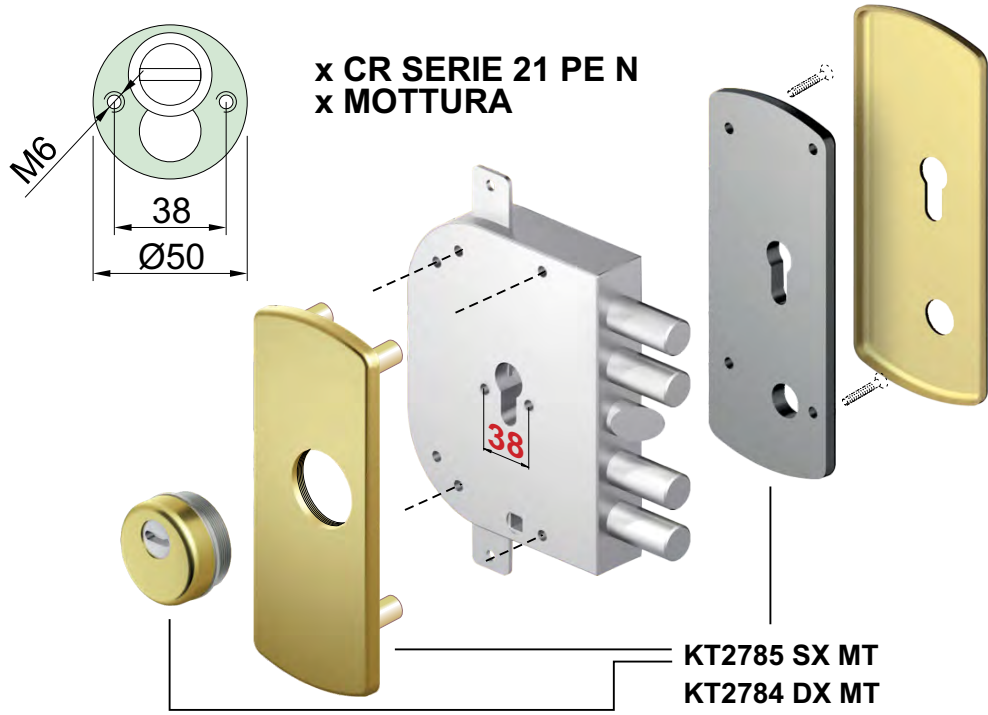

DX

SX

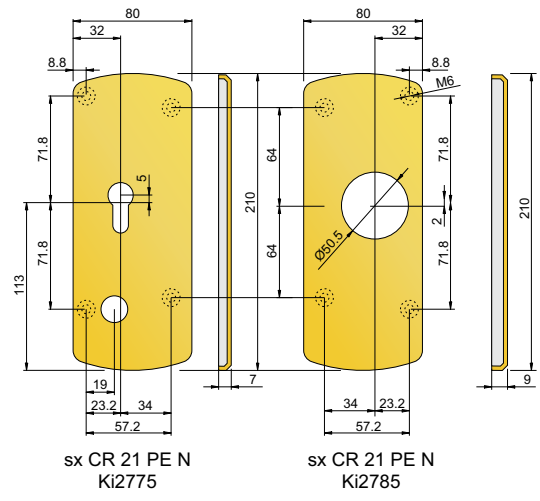
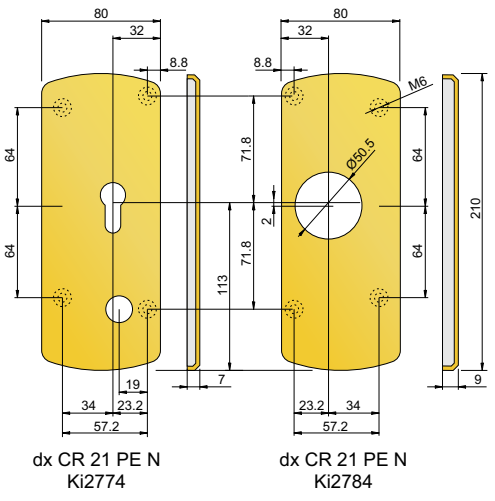



T

Cromo satinato
Satin chrome



iT

Inox satinato
Stainless steel

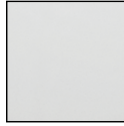

W

Bianco (RAL 9010)
White (RAL 9010)



6

Alluminio silver
Silver aluminium



C

Cromo lucido
Polished chrome

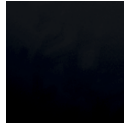

N

Nero
Black



9

Alluminio oro
Gold aluminium



L

Ottone lucido
Polished brass



M

Marrone
Brown



A

Alluminio champagne
Champagne aluminium



BS

Bronzo satinato
Satin bronze



2

PVD ottone
PVD bright brass

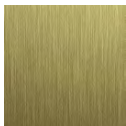

TT

Ottone satinato
Satin brass

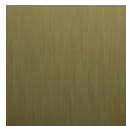

B

Bronzo
Bronze