

LOCKSMITH'S GUIDE 2019

to Adaptors and Optionals for Keyline Machines



KEYLINE

Innovators by design | Since 1770

A BIANCHI 1770 GROUP COMPANY



THE ART OF
DUPLICATION



THE LOCKSMITH'S GUIDE

2019

to Adaptors and Optionals
for Keyline Machines

INDEX / INDICE

The Locksmith's Guide 2019

p	VI
	VIII
	XLII
	XLIV
	XLV
	XLVII
	L
	LI
	LII
	LIII

Key Reader
Key Cutting Machines / Duplicatrici
884 Decryptor Mini
Bluetooth & Power Adaptor
884 Decryptor Ultegra
Keyline Keyless Systems
Keyline TV
Keycenter
Technical Illustrations and Symbols / Illustrazioni Tecniche e Segni Convenzionali
Symbols / Simbologie

p	1
	161
	247
	254
	264
	268
	280
	285

Cylinder Keys / Chiavi Cilindro
Car Keys, Truck Keys, Accessories / Chiavi Auto, Chiavi Camion, Accessori
Cold Forged Keys, Double Bit and Pump Keys / Chiavi Patent, Chiavi a Doppia Mappa e Pompa
Cruciform Keys, Mail Box Keys, Tubular Keys / Chiavi a Croce, Per Casellari Postali, Tubolari
Optional Generic Accessories / Accessori Generici Opzionali
Quick Guide to Laser Key Systems / Guida Veloce ai Sistemi Chiavi Laser
Cutters / Frese
Application Index / Indice per Utilizzo

INTRO

The Locksmith's Guide 2019

The Art of Duplication is the new motto that summarizes Keyline's vision and the constant commitment to creating high-tech tools for talented locksmiths. The new edition of the **2019 Locksmith Guide** is a daily reference tool to be used to navigate the wide world of Keyline.

This is a unique guidebook for the sector that makes the management of spare parts, adapters and optional accessories easy and fast. Starting from a type of key, either residential or automotive, the catalogue will show the necessary mechanical support to duplicate with every Keyline key cutting machine. A complete, clear and well organized volume for fast and clear choices.

The **2019 Locksmith Guide** is part of the Keyline evolution towards a smarter world. A corporate history that dates back to 1770 and that has been constantly improving the work of professional locksmiths in all sectors.

Massimo Bianchi, Keyline Strategic Planner

L'Arte della Duplicazione, il nuovo motto che sintetizza gli orizzonti di Keyline, racchiude l'impegno costante a creare strumenti di alta tecnologia per il talento degli specialisti. E la nuova edizione della **Guida dello Specialista 2019** è lo strumento di consultazione quotidiana per orientarsi nel vasto mondo Keyline.

Una guida unica nel suo genere che rende semplice e veloce muoversi tra ricambi, adattatori e opzionali. A partire dal tipo di chiave, residenziale e automotive, si troveranno indicati i supporti meccanici necessari alla duplicazione con ogni macchina Keyline. Un volume completo, chiaro e ben organizzato, per una scelta rapida e sicura.

La **Guida dello Specialista 2019** è parte dell'evoluzione Keyline per un mondo più smart. Una storia nata nel 1770 e cresciuta migliorando ogni giorno in ogni ambito il lavoro degli specialisti.

Massimo Bianchi, Keyline Strategic Planner

CAMILLO BIANCHI

For edge cut and dimple keys / Per chiavi piatte e punzonate



- STURDY, RAPID AND PRECISE
- DATABASES DIFFERENT BY REGION
- INTUITIVE INTERFACE
- CUSTOMIZED DATABASE SET-UP WITH SELF ACQUISITION FUNCTION*
- AUTOMATIC SOFTWARE UPDATES



- SOLIDO, RAPIDO E PRECISO
- DIFFERENTI DATABASE PER AREA GEOGRAFICA
- INTERFACCIA INTUITIVA
- CREAZIONE DATABASE PERSONALIZZATO TRAMITE FUNZIONE DI AUTO-APPRENDIMENTO*
- AGGIORNAMENTI SOFTWARE AUTOMATICI



Door keys



Car keys





TECHNICAL FEATURES

Voltage	12V - 24W
External Connections	1 USB; 1 LAN
Dimensions	Width: 150 mm / Depth: 300 mm (330 mm with cables) / Height: 300 mm
Weight	4.5 Kg

CARATTERISTICHE TECNICHE

Tensione Elettrica	12V - 24W
Connessioni Esterne	1 USB; 1 LAN
Dimensioni	Larghezza: 150 mm / Profondità: 300 mm (330 mm con cavi) / Altezza: 300 mm
Peso	4,5 Kg

* Function to be purchased separately.
* Funzione acquistabile separatamente.

NINJA TOTAL

For edge cut, laser and dimple keys / Per chiavi piatte, laser e punzonate



- ALL-IN ONE SOLUTION, WITH A DOUBLE CUTTING STATION
- HIGH-SPEED KEY CUTTING
- NEW C30 CLAMP
- INDUSTRIAL CONSOLE WITH THE KEYLINE LIGER SOFTWARE
- HEAD ENGRAVING FUNCTION
- PATENTED AND RELIABLE TECHNOLOGY



- SOLUZIONE ALL-IN ONE, CON DOPPIA STAZIONE DI TAGLIO
- ALTA VELOCITÀ NEL TAGLIO CHIAVI
- NUOVO MORSETTO C30
- CONSOLE INDUSTRIALE CON SOFTWARE LIGER KEYLINE
- FUNZIONE GRAVATURA TESTE
- TECNOLOGIA AFFIDABILE E BREVETTATA



Door keys



Car keys



Ford and Jaguar
Ford e Jaguar

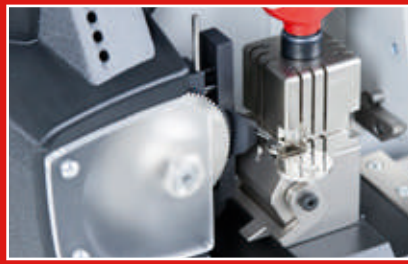

TECHNICAL FEATURES

Power Supply	90-130V 50-60Hz / 220-240V 50-60Hz
Electronic Equipment	Mainboard with ARM Cortex A8 CPU, 256 MB RAM, NAND 1 GB memory, high resolution axes control
External Connections	2 USB 2.0 ports; 2 RS232 serial ports; 1 LAN port
Lighting	2 led strips - lighted cutting bay
Movements/Axes	3 stepper motor-operated axes

EDGE CUT KEY SIDE

DIMPLE KEY AND LASER KEY SIDE

Key Reading/Decoding System	Mechanical tracer with linear sensor	Electric contact
Clamps	4 faces (supplementary clamps are available for specific markets)	C30
Gauge	Automatic gauge unlock through the movement of the axes	
Motor	Asynchronous, 0.18 kW	DC electronic motor
Cutter	In Widia ø 63 mm	In Widia
Cutter Speed	1500-3000 rpm (variable speed according to the programmes)	13000 rpm
Absorption	250W (35W in stand-by)	
Dimensions	Width: 340 mm / Depth: 415 mm / Height: 300 mm	
Weight	30 Kg	

CONSOLE TECHNICAL FEATURES

Power Supply	DC 24V (fed by the key cutting machine)
User Interface	7" industrial colour touch screen, 16:10, resolution 800x480 px, VGA

CARATTERISTICHE TECNICHE

Alimentazione	90-130V 50-60Hz / 220-240V 50-60Hz
Dotazione Elettronica	Mainboard con CPU ARM Cortex A8, 256 MB RAM, memoria NAND 1 GB, controllo assi ad alta risoluzione
Connessioni Esterne	2 porte USB; 2 porte seriali RS232; 1 LAN
Illuminazione	Area di lavoro illuminata con 2 strisce led
Movimenti/Assi	3 assi pilotati da motori passo passo

LATO CHIAVI PIATTE

LATO CHIAVI PUNZONATE E LASER

Sistema di Lettura/Decodifica Chiave	Tastatore meccanico con sensore lineare	Contatto elettrico
Morsetti	4 facce (sono disponibili ulteriori morsetti per mercati specifici)	C30
Calibro	Sblocco calibro automatico tramite movimento assi	
Motore	Asincrono 0,18 kW	Elettronico DC
Fresa	In Widia ø 63 mm	In Widia
Velocità Fresa	1500-3000 rpm (velocità variabile a seconda dei programmi)	13000 rpm
Assorbimento	250W (35W in stand-by)	
Dimensioni	Larghezza: 340 mm / Profondità: 415 mm / Altezza: 300 mm	
Peso	30 Kg	

CARATTERISTICHE TECNICHE CONSOLE

Alimentazione	DC 24V (alimentata dalla duplicatrice)
Interfaccia Utente	Schermo touch screen industriale a colori, 7", 16:10, risoluzione 800x480 px, VGA

*More versions for specific markets are available.
 *Disponibili ulteriori versioni per i mercati specifici.

NINJA

For edge cut and cruciform keys / Per chiavi piatte e a croce



- | | |
|--|---|
| <ul style="list-style-type: none"> ▪ ELECTRONIC AND AUTOMATIC ▪ COMPACT DESIGN ▪ INTERACTIVE INTERFACE ▪ MULTIPLE CUTTING SPEEDS ▪ UNLIMITED DATABASE WITH ON BOARD CROSS REFERENCE ▪ HERMETIC CUTTING BAY | <ul style="list-style-type: none"> ▪ ELETTRONICA E AUTOMATICA ▪ DESIGN COMPATTO ▪ INTERFACCIA INTERATTIVA ▪ VELOCITÀ DI TAGLIO MULTIPLE ▪ DATABASE ILLIMITATO CON COMPARATIVO A BORDO ▪ AREA DI TAGLIO ERMETICA |
|--|---|

Door keys



Car keys





TECHNICAL FEATURES

Power Supply	90-130V 50-60Hz / 220-240V 50-60Hz
Electronic Equipment	Mainboard with ARM Cortex A8 CPU, 256 MB RAM, NAND 1 GB memory, high resolution axes control
External Connections	2 USB 2.0 ports; 2 RS232 serial ports; 1 LAN port
Key Reading/Decoding System	Electric contact
Lighting	LED - lighted cutting bay
Movements/Axes	2 stepper motor-operated axes
Clamps	4 faces (supplementary clamps are available for specific markets)
Gauge	Automatic gauge unlock through the movement of the axes
Motor	Asynchronous, 0.18 kW
Cutter	In Widia \varnothing 63 mm
Cutter Speed	1500-3000 rpm (variable speed according to the programmes)
Absorption	250W (35W in stand-by)
Dimensions	Width: 340 mm / Depth: 415 mm / Height: 300 mm
Weight	20 Kg

CONSOLE TECHNICAL FEATURES

Power Supply	DC 24V (fed by the key cutting machine)
User Interface	7" industrial color touch screen, 16:10, resolution 800x480 px, VGA, quick duplication button

CARATTERISTICHE TECNICHE

Alimentazione	90-130V 50-60Hz / 220-240V 50-60Hz
Dotazione Elettronica	Mainboard con CPU ARM Cortex A8, 256 MB RAM, memoria NAND 1 GB, controllo assi ad alta risoluzione
Conessioni Esterne	2 porte USB; 2 porte seriali RS232; 1 LAN
Sistema di Lettura/Decodifica Chiave	Contatto elettrico
Illuminazione	Area di lavoro illuminata a LED
Movimenti/Assi	2 assi pilotati da motori passo passo
Morsetti	4 facce (sono disponibili ulteriori morsetti per mercati specifici)
Calibro	Sblocco calibro automatico tramite movimento assi
Motore	Asincrono 0,18 kW
Fresa	In Widia \varnothing 63 mm
Velocità Fresa	1500-3000 rpm (velocità variabile a seconda dei programmi)
Assorbimento	250W (35W in stand-by)
Dimensioni	Larghezza: 340 mm / Profondità: 415 mm / Altezza: 300 mm
Peso	20 Kg

CARATTERISTICHE TECNICHE CONSOLE

Alimentazione	DC 24V (alimentata dalla duplicatrice)
Interfaccia Utente	Schermo touch screen industriale a colori, 7", 16:10, risoluzione 800x480 px, VGA, tasto copia veloce

*More versions for specific markets are available.

*Disponibili ulteriori versioni per i mercati specifici.

DEZMO

For edge cut and cruciform keys / Per chiavi piatte e a croce



- OPTICAL READING
- INTERACTIVE INTERFACE
- MULTIPLE CUTTING SPEEDS
- UNLIMITED DATABASE WITH ON BOARD CROSS REFERENCE
- CARD MAKER
- UNIVERSAL ELECTRONIC FEEDER (INDEPENDENT)

- LETTURA OTTICA
- INTERFACCIA INTERATTIVA
- VELOCITÀ DI TAGLIO MULTIPLE
- DATABASE ILLIMITATO CON COMPARATIVO A BORDO
- CARD MAKER
- CARICATORE UNIVERSALE ELETTRONICO (INDIPENDENTE)

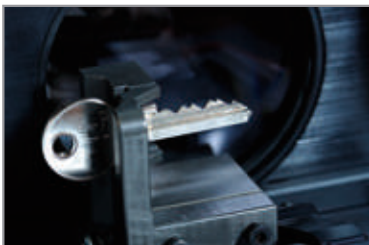

Door keys



Car keys



TECHNICAL FEATURES

Power Supply	90-130V 50-60Hz / 220-240V 50-60Hz
User Interface	7" industrial color touch screen, 16:10, resolution 800x480 px, VGA
Electronic Equipment	Mainboard with 600 MHz CPU GEODE, 512 MB RAM, static memory on 4 GB compact flash, high resolution axes control
External Connections	2 USB ports; 1 LAN /Ethernet port; 1 VGA socket
Key Reading/Decoding System	Static reading from digital image (Optical + CCD)
Movements/Axes	2 stepper motor-operated axes
Clamps	4-faces (electronic identification of the cutting side in Dezmo Open and Dezmo Advance)
Gauge	Automatic in Dezmo Open and Dezmo Advance
Motor	Brushless
Cutter	In Widia \varnothing 80 mm
Cutter Speed	2000-3000 rpm (variable speed according to the programmes)
Absorption	Dezmo basic: 400W (75W in stand-by); Dezmo Advance: 400W (100W in stand-by)
Dimensions	Width: 525 mm / Depth: 500 mm / Height: 450 mm
Weight	45 Kg

FEEDER TECHNICAL FEATURES

Feeder Insertion	Can be integrated in Dezmo Open
Feeder Activated by	Electric motors
Key Installation in the Feeder	No tags (only stacker adjustment)
Key Thickness	Min 1.8 mm - Max 4.0 mm
Length and Width of the Blade	Length: Min 20 - Max 40 mm; Width: Min 6 - Max 10 mm
Length and Width of the Head	Length: Min 15 - Max 40 mm; Width: Min 15 - Max 42 mm
Number of Keys in the Stacker	60 (2.2 mm - thickness)
Key Positioning	Automatic positioning on A or B side according to key dimensions
Total Dimensions of the Machine with its Feeder	Width: 885 mm / Depth: 500 mm / Height: 450 mm
Weight	20 Kg

CARATTERISTICHE TECNICHE

Alimentazione	90-130V 50-60Hz / 220-240V 50-60Hz
Interfaccia Utente	Schermo touchscreen industriale a colori, 7", 16:10, risoluzione 800x480 px, VGA
Dotazione Elettronica	Mainboard con CPU GEODE a 600 MHz, 512 MB RAM, memoria statica su compact flash 4 GB, controllo assi ad alta risoluzione
Conessioni Esterne	2 porte USB; 1 porta LAN/Ethernet; 1 porta VGA
Sistema di Lettura/Decodifica Chiave	Letture statica da immagine digitale (Ottica+CCD)
Movimenti/Assi	2 assi pilotati da motori passo passo
Morsetti	4 facce (riconoscimento elettronico del lato di taglio in Dezmo Open e Dezmo Advance)
Calibro	Automatico in Dezmo Open e Dezmo Advance
Motore	Brushless
Fresa	In Widia \varnothing 80 mm
Velocità Fresa	2000-3000 rpm (velocità variabile a seconda dei programmi)
Assorbimento	Dezmo base: 400W (75W in stand-by); Dezmo Advance: 400W (100W in stand-by)
Dimensioni	Larghezza: 525 mm / Profondità: 500 mm / Altezza: 450 mm
Peso	45 Kg

CARATTERISTICHE TECNICHE CARICATORE

Applicazione del Caricatore	Integrabile con Dezmo Open
Caricatore attivato da	Motori elettrici
Installazione delle Chiavi nel Caricatore	No piastrine (solo regolazione dell'impilatore)
Spessore Chiavi	Min 1,8 mm - Max 4,0 mm
Lunghezza e Larghezza della Canna	Lunghezza: Min 20 - Max 40 mm; Larghezza: Min 6 - Max 10 mm
Lunghezza e Larghezza della Testa	Lunghezza: Min 15 - Max 40 mm; Larghezza: Min 15 - Max 42 mm
Numero di Chiavi nell'Impilatore	60 (2,2 mm - spessore)
Posizionamento Chiave	Posizionamento automatico sul lato A o B a seconda delle dimensioni della chiave
Dimensioni Totali della Macchina con Caricatore	Larghezza: 885 mm / Profondità: 500 mm / Altezza: 450 mm
Peso	20 Kg

Dezmo is available in three versions:

- **Dezmo** – stand alone version;
- **Dezmo Open** – equipped for the installation of the robotized feeder;
- **Dezmo Advance** – version with an integrated robotized feeder.

Dezmo è disponibile in tre versioni:

- **Dezmo** – versione stand alone;
- **Dezmo Open** – predisposta per l'installazione del caricatore robotizzato;
- **Dezmo Advance** – versione integrata con caricatore robotizzato.

*More versions for specific markets are available.
*Disponibili ulteriori versioni per i mercati specifici.

NINJA LASER

For edge cut and laser keys / Per chiavi piatte e laser



- | | | | |
|--|---|---|---|
| <ul style="list-style-type: none"> ▪ ELECTRONIC AND AUTOMATIC ▪ COMPACT DESIGN ▪ INTERACTIVE INTERFACE ▪ UNLIMITED DATABASE WITH ON BOARD CROSS REFERENCE ▪ DOUBLE CUTTER FOR EDGE CUT AND LASER KEYS |  | <ul style="list-style-type: none"> ▪ ELETTRONICA E AUTOMATICA ▪ DESIGN COMPATTO ▪ INTERFACCIA INTERATTIVA ▪ DATABASE ILLIMITATO CON COMPARATIVO A BORDO ▪ DOPPIA FRESA PER CHIAVI PIATTE E LASER |  |
|--|---|---|---|

Door keys



Car keys



Ford and Jaguar
Ford e Jaguar



TECHNICAL FEATURES

Power Supply	90-130V 50-60Hz / 220-240V 50-60Hz
Electronic Equipment	Mainboard with ARM Cortex A8 CPU, 256 MB RAM, NAND 1 GB memory, high resolution axes control
External Connections	2 USB 2.0 ports; 2 RS232 serial ports; 1 LAN port
Key Reading/Decoding System	Electric contact
Lighting	LED - lighted cutting bay
Movements/Axes	2 stepper motor-operated axes

EDGE CUT KEY SIDE

LASER KEY SIDE

Clamps	4 faces (supplementary clamps are available for specific markets)	Clamp AC (clamps A, B, C, D, H, V are available)
Gauge	Automatic gauge unlock through the movement of the axes	
Motor	Asynchronous, 0.18 kW	DC electronic motor
Cutter	In Widia \varnothing 63 mm	In Widia \varnothing 2.5 mm
Cutter Speed	1500-3000 rpm (variable speed according to the programmes)	6000 rpm
Absorption	250W (35W in stand-by)	
Dimensions	Width: 340 mm / Depth: 415 mm / Height: 300 mm	
Weight	20 Kg	

CONSOLE TECHNICAL FEATURES

Power Supply	DC 24V (fed by the key cutting machine)
User Interface	7" industrial colour touch screen, 16:10, resolution 800x480 px, VGA

CARATTERISTICHE TECNICHE

Alimentazione	90-130V 50-60Hz / 220-240V 50-60Hz
Dotazione Elettronica	Mainboard con CPU ARM Cortex A8, 256 MB RAM, memoria NAND 1 GB, controllo assi ad alta risoluzione
Connessioni Esterne	2 porte USB; 2 porte seriali RS232; 1 LAN
Sistema di Lettura/Decodifica Chiave	Contatto elettrico
Illuminazione	Area di lavoro illuminata a LED
Movimenti/Assi	2 assi pilotati da motori passo passo

LATO CHIAVI PIATTE

LATO CHIAVI LASER

Morsetti	4 facce (sono disponibili ulteriori morsetti per mercati specifici)	Morsetto AC (sono disponibili i morsetti A, B, C, D, H, V)
Calibro	Sblocco calibro automatico tramite movimento assi	
Motore	Asincrono 0,18 kW	Elettronico DC
Fresa	In Widia \varnothing 63 mm	In Widia \varnothing 2,5 mm
Velocità Fresa	1500-3000 rpm (velocità variabile a seconda dei programmi)	6000 rpm
Assorbimento	250W (35W in stand-by)	
Dimensioni	Larghezza: 340 mm / Profondità: 415 mm / Altezza: 300 mm	
Peso	20 Kg	

CARATTERISTICHE TECNICHE CONSOLE

Alimentazione	DC 24V (alimentata dalla duplicatrice)
Interfaccia Utente	Schermo touch screen industriale a colori, 7", 16:10, risoluzione 800x480 px, VGA

*More versions for specific markets are available.
*Disponibili ulteriori versioni per i mercati specifici.

994 LASER

For edge cut and laser automotive keys / Per chiavi piatte e laser automotive



▪ ERGONOMIC DESIGN

▪ PRECISION MECHANICS

▪ INTERACTIVE INTERFACE

▪ STABILIZED CUTTING SPEED

▪ UNLIMITED DATABASE WITH ON BOARD CROSS REFERENCE

▪ 8 CLAMPS FOR ALL AUTOMOTIVE KEYS



▪ DESIGN ERGONOMICO

▪ MECCANICA DI PRECISIONE

▪ INTERFACCIA INTERATTIVA

▪ VELOCITÀ DI TAGLIO STABILIZZATA

▪ DATABASE ILLIMITATO CON COMPARATIVO A BORDO

▪ 8 MORSETTI PER TUTTE LE CHIAVI AUTOMOTIVE



Car keys



Ford and Jaguar
Ford e Jaguar



TECHNICAL FEATURES

Power Supply	90-130V 50-60Hz / 220-240V 50-60Hz
Electronic Equipment	Mainboard with CPU ARM Cortex A8, 256 MB RAM, NAND memory on 1 GB, high resolution axes control
External Connections	2 USB 2.0 ports; 2 RS232 serial ports; 1 LAN port
Key Reading/Decoding System	Electric contact
Movements/Axes	2 axes, guided by stepper motors through linear moves, interpolated through high precision ball screws
Clamps	8 clamps are available: A, B, C, D for laser keys; G for edge cut automotive keys (patented); H for Tibbe keys (6 spaces); S for Simplex keys; V for Volkswagen laser keys
Motor	Brushless
Cutter	Widia \varnothing 2.5 mm for laser and Tibbe keys / \varnothing 1.5 mm for edge cut keys
Cutter Speed	6000 rpm
Absorption	125W (50W in stand-by)
Dimensions	Width: 300 mm / Depth: 360 mm / Height: 350 mm
Weight	Machine body 16.5 Kg / Console 0.8 Kg

CONSOLE TECHNICAL FEATURES

Power Supply	DC 24V (fed by the key cutting machine)
User Interface	7" industrial color touch screen, 16:10, resolution 800x480 px, incorporated CPU

CARATTERISTICHE TECNICHE

Alimentazione	90-130V 50-60Hz / 220-240V 50-60Hz
Dotazione Elettronica	Mainboard con CPU ARM Cortex A8, 256 MB RAM, memoria NAND 1 GB, controllo assi ad alta risoluzione
Connessioni Esterne	2 porte USB; 2 porte seriali RS232; 1 LAN
Sistema di Lettura/Decodifica Chiave	Contatto elettrico
Movimenti/Assi	2 assi pilotati da motori passo passo su movimenti lineari interpolati tramite viti a ricircolo di sfere di alta precisione
Morsetti	Disponibili 8 morsetti: A, B, C, D per chiavi laser; G per chiavi piatte automotive (brevettato); H per chiavi Tibbe (6 spazi); S per chiavi Simplex; V per chiavi laser Volkswagen
Motore	Brushless
Fresa	Widia \varnothing 2,5 mm per chiavi laser e Tibbe / \varnothing 1,5 mm per chiavi piatte
Velocità Fresa	6000 rpm
Assorbimento	125W (50W in stand-by)
Dimensioni	Larghezza: 300 mm / Profondità: 360 mm / Altezza: 350 mm
Peso	Corpo macchina 16,5 Kg / Console 0,8 Kg

CARATTERISTICHE TECNICHE CONSOLE

Alimentazione	DC 24V (alimentata dalla duplicatrice)
Interfaccia utente	Schermo touch screen industriale a colori, 7", 16:10, risoluzione 800x480 px, CPU incorporato

NINJA VORTEX

For laser and dimple keys / Per chiavi laser e punzate



- COMPACT DESIGN
- INTERACTIVE INTERFACE
- UNLIMITED DATABASE WITH ON BOARD CROSS REFERENCE
- HIGH DECODE AND CUT SPEED
- GRAPHIC ENGRAVING ON KEY HEADS
- DESIGN COMPATTO
- INTERFACCIA INTERATTIVA
- DATABASE ILLIMITATO CON COMPARATIVO A BORDO
- ALTA VELOCITÀ DI DECODIFICA E TAGLIO
- INCISIONE GRAFICA SULLE TESTE

Door keys



Car keys





TECHNICAL FEATURES

Power Supply	90-130V 50-60Hz / 220-240V 50-60Hz
Electronic Equipment	Mainboard with ARM Cortex A8 CPU, 256 MB RAM, NAND 1 GB memory, high resolution axes control
External Connections	2 USB 2.0 ports; 2 RS232 serial ports; 1 LAN port
Key Reading/Decoding System	Electric contact
Lighting	LED - lighted cutting bay
Movements/Axes	3 stepper motor-operated axes
Clamps	Standard equipment includes 4 basic clamps: A01, A02, A03 for laser-type car keys; C01 for dimple keys; other models available upon request
Motor	DC electronic motor
Cutter	Equipment with the following Widia cutters: 1 pc. blade \varnothing 4 mm, 90° cutting edge 0.4 mm (for dimple keys); 1 pc. blade \varnothing 4 mm, cutting edge \varnothing 2.5 mm (for car keys); other models available upon request
Cutter Speed	10000 rpm
Absorption	250W (35W in stand-by)
Dimensions	Width: 340 mm / Depth: 415 mm / Height: 300 mm
Weight	19 Kg

CONSOLE TECHNICAL FEATURES

Power Supply	DC 24V (fed by the key cutting machine)
User Interface	7" industrial colour touch screen, 16:10, resolution 800x480 px, VGA

CARATTERISTICHE TECNICHE

Alimentazione	90-130V 50-60Hz / 220-240V 50-60Hz
Dotazione Elettronica	Mainboard con CPU ARM Cortex A8, 256 MB RAM, memoria NAND 1 GB, controllo assi ad alta risoluzione
Conessioni Esterne	2 porte USB; 2 porte seriali RS232; 1 LAN
Sistema di Lettura/Decodifica Chiave	Contatto elettrico
Illuminazione	Area di lavoro illuminata a LED
Movimenti/Assi	3 assi pilotati da motori passo passo
Morsetti	Dotazione di 4 morsetti base: A01, A02, A03 per chiavi auto tipo laser; C01 per chiavi punzonate; altri modelli a richiesta
Motore	Elettronico DC
Fresa	Dotazione delle seguenti frese in Widia: 1 pz gambo \varnothing 4 mm, taglienti a 90° base 0,4 mm (per chiavi punzonate); 1 pz gambo \varnothing 4 mm, taglienti \varnothing 2,5 mm (per chiavi auto); altri modelli a richiesta
Velocità Fresa	10000 rpm
Assorbimento	250W (35W in stand-by)
Dimensioni	Larghezza: 340 mm / Profondità: 415 mm / Altezza: 300 mm
Peso	19 Kg

CARATTERISTICHE TECNICHE CONSOLE

Alimentazione	DC 24V (alimentata dalla duplicatrice)
Interfaccia Utente	Schermo touch screen industriale a colori, 7", 16:10, risoluzione 800x480 px, VGA

VERSA

For laser and dimple keys / Per chiavi laser e punzate



- HERMETIC CUTTING BAY
 - INTERACTIVE INTERFACE
 - MULTIPLE CUTTING SPEEDS
 - UNLIMITED DATABASE WITH CODES AND TECHNICAL PARAMETERS
 - STANDARD CLAMP COVERING THE 70% OF INSERTED SYSTEMS
 - GRAPHIC ENGRAVING ON KEY HEADS
-
- AREA DI LAVORO ERMETICA
 - INTERFACCIA INTERATTIVA
 - VELOCITÀ DI TAGLIO MULTIPLE
 - DATABASE ILLIMITATO CON CODICI E PARAMETRI TECNICI DI DUPLICAZIONE
 - MORSETTO STANDARD CON COPERTURA DEL 70% DEI SISTEMI INSERITI
 - INCISIONE GRAFICA SULLE TESTE

Door keys



Car keys





TECHNICAL FEATURES

Power Supply	90-130V 50-60Hz / 220-240V 50-60Hz
User Interface	7" industrial color touch screen, 16:10, resolution 800x480 px, VGA
Electronic Equipment	Mainboard with 600 MHz CPU GEODE, 512 MB RAM, static memory on 4 GB compact flash, high resolution axes control
External Connections	2 USB ports, 1 LAN /Ethernet port; 1 RS232 serial port (9 pin); 1 VGA socket (for touch screen / std video display)
Key Reading/Decoding System	Electric contact
Movements/Axes	3 axes, guided by stepper motors through linear moves, interpolated through high precision ball screws
Clamps	Standard equipment includes 4 basic clamps: A01, A02, A03 for laser-type car keys; C01 master for dimple keys and bow etching; supplementary models available upon request
Motor	Brushless
Cutter	Equipment with the following Widia cutters: 1 pc. blade \varnothing 4 mm, cutting edge \varnothing 2.5 mm (for car keys); 1 pc. blade \varnothing 4 mm, 90° cutting edge 0.4 mm (for cylinder keys); other models available upon request
Cutter Speed	28000 rpm
Absorption	230W
Dimensions	Width: 500 mm / Depth: 430 mm / Height: 375 mm
Color Available	Red / Silver
Weight	37 Kg

CARATTERISTICHE TECNICHE

Alimentazione	90-130V 50-60Hz / 220-240V 50-60Hz
Interfaccia Utente	Schermo touchscreen industriale a colori, 7", 16:10, risoluzione 800x480 px, VGA
Dotazione Elettronica	Mainboard con CPU GEODE a 600 MHz, 512 MB RAM, memoria statica su compact flash 4 GB, controllo assi ad alta risoluzione
Connessioni Esterne	2 Porte USB; 1 Porta Seriale RS232 (9 pin); 1 Porta LAN / Ethernet; 1 Presa VGA (per display - touch screen / std video)
Sistema di Lettura/Decodifica Chiave	Contatto elettrico
Movimenti/Assi	3 assi pilotati da motori passo passo su movimenti lineari interpolati tramite viti a ricircolo di sfere di alta precisione
Morsetti	Dotazione di 4 morsetti base: A01, A02, A03 per chiavi auto tipo laser; C01 master per chiavi punzonate ed incisione testa; altri modelli a richiesta
Motore	Brushless
Fresa	Dotazione delle seguenti frese in Widia: 1 pz gambo \varnothing 4 mm, taglienti \varnothing 2,5 mm (per chiavi auto); 1 pz gambo \varnothing 4 mm, taglienti a 90° base 0,4 mm (per chiavi cilindro); altri modelli a richiesta
Velocità Fresa	28000 rpm
Assorbimento	230W
Dimensioni	Larghezza: 500 mm / Profondità: 430 mm / Altezza: 375 mm
Colori disponibili	Rosso / Argento
Peso	37 Kg

SIGMA PRO

For bit and pump keys / Per chiavi a mappa e a pompa



- OPTICAL READING
 - HYPERFAST DUPLICATION
 - INTERACTIVE INTERFACE
 - READING AREA SEPARATED FROM THE CUTTING BAY
 - CARD MAKER
 - EASY-TO-UPDATE AND ADVANCED SOFTWARE TOOLS
-
- LETTURA OTTICA
 - DUPLICAZIONE ULTRARAPIDA
 - INTERFACCIA INTERATTIVA
 - VANO DI LETTURA SEPARATO DAL TAGLIO
 - CARD MAKER
 - STRUMENTI SOFTWARE AVANZATI FACILMENTE AGGIORNABILI

Door keys



Car keys



Ford and Jaguar
Ford e Jaguar

TECHNICAL FEATURES

Power Supply	AC 100-240 V, 50-60 Hz
User Interface	7" industrial color touch screen, 16:10, resolution 800x480 px, VGA
Electronic Equipment	Mainboard with 600 MHz CPU GEODE, 512 MB RAM, static memory on 4 GB compact flash, high resolution axes control
External Connections	1 USB 2.0 port; 1 RS485 serial port; 1 Ethernet port; 1 VGA port
Key Reading/Decoding System	Static reading from digital image (Optical + CCD)
Lighting	LED-lighted cutting bay
Movements/Axes	3 axes guided by stepper motors
Clamps	Equipment in relation to specific markets
Motor	Brushless
Cutter	In Widia \varnothing 100x1.25 mm
Cutter Speed	900-1800 rpm (variable speed according to the programmes)
Absorption	500W (70W in stand-by)
Dimensions	Width: 500 mm / Depth: 440 mm / Height: 450 mm (600 mm when the housing is open)
Weight	45 Kg

CARATTERISTICHE TECNICHE

Alimentazione	AC 100-240 V, 50-60 Hz
Interfaccia Utente	Schermo touchscreen industriale a colori, 7", 16:10, risoluzione 800x480 px, VGA
Dotazione Elettronica	Mainboard con CPU GEODE a 600 MHz, 512 MB RAM, memoria statica su compact flash 4 GB, controllo assi ad alta risoluzione
Connessioni Esterne	1 Porta USB 2.0; 1 Porta seriale RS485; 1 Porta Ethernet; 1 Porta VGA
Sistema di Lettura/Decodifica Chiave	Lettura statica da immagine digitale (Ottica + CCD)
Illuminazione	Area di lavoro illuminata a LED
Movimenti/Assi	3 assi pilotati da motori passo passo
Morsetti	Dotazione in relazione ai mercati specifici
Motore	Brushless
Fresa	In Widia \varnothing 100x1,25 mm
Velocità Fresa	900-1800 rpm (velocità variabile a seconda dei programmi)
Assorbimento	500W (70W in stand-by)
Dimensioni	Larghezza: 500 mm / Profondità: 440 mm / Altezza: 450 mm (600 mm a carter aperto)
Peso	45 Kg



CARAT

For edge cut and cruciform keys / Per chiavi piatte e a croce



- CARRIAGE AND GAUGE UNLOCK BUTTON
- EASY SELECTION OF CLAMP SIDE
- CLAMPS LOCKING WITH ERGONOMIC HANDLE
- LAMP CONTROLLED BY AN INDEPENDENT SWITCH
- PULSANTE SGANCIO CARRELLO E SGANCIO CALIBRO
- FACILE SELEZIONE DEL LATO MORSETTO
- CHIUSURA MORSETTI CON MANOPOLA ERGONOMICA
- LAMPADA CONTROLLATA DA INTERRUOTTORE INDIPENDENTE

Door keys



Car keys



with adaptor
con adattatore



TECHNICAL FEATURES

VERSION	Carat Duo	Carat Quattro	Carat Quattro W
Power Supply	230V 50Hz / 110V 60Hz / 100V 50-60Hz		
Lighting	Neon		
Movements/Axes	2 axes		
Clamps	2/4 faces; more versions for specific markets are available		
Tracer	Hardened with regulation nuts		
Motor	Asynchronous, single speed, 0.25 kW		
Cutter	HSS ø 80 mm	In Widia ø 80 mm	
Cutter Speed	640 rpm	1400 rpm	
Brush	Tynex		
Dimensions	Width: 400 mm / Depth: 460 mm / Height: 270 mm (without lamp); 440 mm (with lamp)		
Weight	25 Kg		

CARATTERISTICHE TECNICHE

VERSIONE	Carat Duo	Carat Quattro	Carat Quattro W
Alimentazione	230V 50Hz / 110V 60Hz / 100V 50-60Hz		
Illuminazione	Neon		
Movimenti/Assi	2 assi		
Morsetti	2/4 facce; sono disponibili ulteriori versioni per mercati specifici		
Tastatore	Temprato con ghiera di regolazione		
Motore	Asincrono, singola velocità, 0,25 kW		
Fresa	HSS ø 80 mm	Widia ø 80 mm	
Velocità Fresa	640 rpm	1400 rpm	
Spazzola	Tynex		
Dimensioni	Larghezza: 400 mm / Profondità: 460 mm / Altezza: 270 mm (senza lampada); 440 mm (con lampada)		
Peso	25 Kg		

*More versions for specific markets are available.

*Disponibili ulteriori versioni per i mercati specifici.

NINJA DARK

For edge cut and cruciform keys / Per chiavi piatte e a croce



- **AUTOMATIC**
 - **COMPACT DESIGN**
 - **QUICK COPY IN A SINGLE STEP**
 - **MICROMETRIC SYSTEM OF CALIBRATION**
 - **OPTIONAL CONSOLE FOR ADVANCED FUNCTIONS**
-
- **AUTOMATICA**
 - **DESIGN COMPATTO**
 - **COPIA VELOCE IN UN SOLO PASSAGGIO**
 - **SISTEMA MICROMETRICO DI TARATURA**
 - **CONSOLE INTEGRABILE PER FUNZIONI AVANZATE**

Door keys



Car keys



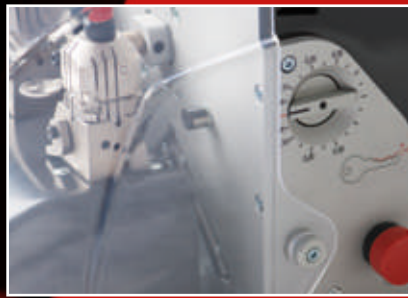

TECHNICAL FEATURES

Power Supply	90-130V 50-60Hz / 220-240V 50-60Hz
Electronic Equipment	High resolution axes control
External Connections	1 RS232 serial port
Lighting	LED - lighted cutting bay
Movements/Axes	2 stepper motor-operated axes
Clamps	4 faces; more clamps are available for specific markets
Gauge	Automatic gauge unlock through the movement of the axes
Tracer	Hardened
Motor	Asynchronous; 0.18 kW
Cutter	In Widia \varnothing 63 mm
Cutter Speed	2000 rpm
Absorption	250W (15W in stand-by)
Dimensions	Width: 340 mm / Depth: 415 mm / Height: 300 mm
Weight	20 Kg

CARATTERISTICHE TECNICHE

Alimentazione	90-130V 50-60Hz / 220-240V 50-60Hz
Dotazione Elettronica	Controllo assi ad alta risoluzione
Connessioni Esterne	1 porta seriale RS232
Illuminazione	Area di lavoro illuminata a LED
Movimenti/Assi	2 assi pilotati da motori passo passo
Morsetti	4 facce; sono disponibili ulteriori morsetti per mercati specifici
Calibro	Sblocco calibro automatico tramite movimento assi
Tastatore	Temprato
Motore	Asincrono 0,18 kW
Fresa	In Widia \varnothing 63 mm
Velocità Fresa	2000 rpm
Assorbimento	250W (15W in stand-by)
Dimensioni	Larghezza: 340 mm / Profondità: 415 mm / Altezza: 300 mm
Peso	20 Kg

*More versions for specific markets are available.

*Disponibili ulteriori versioni per i mercati specifici.

EASY

For edge cut and cruciform keys / Per chiavi piatte e a croce



- REVERSIBLE CLAMPS
- INDEPENDENT SWITCH FOR THE BRUSH
- CARRIAGE SAFETY MICROSWITCH
- MORSETTI REVERSIBILI
- INTERRUOTTORE INDIPENDENTE DELLA SPAZZOLA
- MICROINTERRUPTORE DI SICUREZZA SUL CARRELLO

Door keys



Car keys



TECHNICAL FEATURES

VERSION	Easy	Easy Quattro
Power Supply	230V 50Hz / 110V 60Hz	
Movements/Axes	2 axes	
Clamps	2 faces	4 faces
Tracer	Hardened	
Motor	Asynchronous one speed	
Cutter	HSS 80x5x16 mm	
Cutter Speed	700 rpm	
Brush	Tynex	
Absorption	200W	
Dimensions	Width: 370 mm / Depth: 370 mm / Height: 240 mm	
Weight	19 Kg	

CARATTERISTICHE TECNICHE

VERSIONE	Easy	Easy Quattro
Alimentazione	230V 50Hz / 110V 60Hz	
Movimenti/Assi	2 assi	
Morsetti	2 facce	4 facce
Tastatore	Temprato	
Motore	Asincrono a una velocità	
Fresa	HSS 80x5x16 mm	
Velocità Fresa	700 rpm	
Spazzola	Tynex	
Assorbimento	200W	
Dimensioni	Larghezza: 370 mm / Profondità: 370 mm / Altezza: 240 mm	
Peso	19 Kg	

T-REX | T-REX ADVANCE

For laser, dimple and tubular keys / Per chiavi laser, punzonate e tubolari



- INNOVATIVE FIXED CLAMPS WITH 3 CLAMPING SYSTEMS
- INTUITIVE LED PANEL THAT FACILITATES OPERATIONS ON THE MACHINE
- NON-GLARE WORKING PLATFORM LIGHTING, TO WORK SAFELY
- STRONG AND ERGONOMIC STRUCTURE, FLUID MOVEMENTS
- PATENTED TECHNOLOGY FOR THE MOTORIZED TOOL POSITIONING SYSTEM*



- INNOVATIVI MORSETTI CON 3 SISTEMI DI TENUTA CHIAVI
- PANNELLO A LED INTUITIVO CHE FACILITA LE OPERAZIONI A BORDO MACCHINA
- ILLUMINAZIONE PIANO LAVORO SENZA EFFETTO ABBAGLIAMENTO PER OPERARE IN SICUREZZA
- STRUTTURA ROBUSTA ED ERGONOMICA, MOVIMENTAZIONE FLUIDA
- TECNOLOGIA BREVETTATA PER SISTEMA DI CAMBIO UTENSILI MOTORIZZATO*



Door keys



Car keys



with adaptor
con adattatore



* Only for the T-Rex Advance version
* Solo per la versione T-Rex Advance



TECHNICAL FEATURES

MODEL	T-Rex	T-Rex Advance
Power Supply	230V 50Hz / 110V 60Hz / 100V 50-60Hz	
Lighting	Led	
Movements/Axes	3 axes with sliding guides	
Clamps	Fixed with interchangeable tools	Tilting with interchangeable tools
Motor	Asynchronous; with 0.18 kW speed	Asynchronous; with 0.18 kW variable speed
Cutter	HSS \varnothing 6 mm	HSS \varnothing 6 mm (optionals in Widia)
Cutter Speed	6000 rpm	From 6000 rpm to 12000 rpm
Tools Positioning	Manual	Motorized
Absorption	200W	300W
Dimensions	Width: 320 mm / Depth: 420 mm (with chip tray 475 mm) / Height: 490 mm	
Weight	24 Kg	25 Kg

CARATTERISTICHE TECNICHE

MODELLO	T-Rex	T-Rex Advance
Alimentazione	230V 50Hz / 110V 60Hz / 100V 50-60Hz	
Illuminazione	Led	
Movimenti/Assi	Su 3 assi con guide a sfere	
Morsetti	Fisso con piastrine intercambiabili	Basculante con piastrine intercambiabili
Motore	Motore asincrono ad una velocità 0,18 kW	Motore asincrono a velocità regolabile 0,18 kW
Fresa	HSS \varnothing 6 mm	HSS \varnothing 6 mm (opzionali in Widia)
Velocità Fresa	6000 rpm	Da 6000 rpm a 12000 rpm
Cambio Utensili	Manuale	Motorizzato
Assorbimento	200W	300W
Dimensioni	Larghezza: 320 mm / Profondità: 420 mm (con cassetto raccogli trucioli 475 mm) / Altezza: 490 mm	
Peso	24 Kg	25 Kg

*More versions for specific markets are available.
 *Disponibili ulteriori versioni per i mercati specifici.

PUNTO

For laser and dimple keys / Per chiavi laser e punzionate



- MILLING CUTTERS AND TRACERS HOLDER
- WIDE AND MOVABLE PROTECTION SHIELD
- VERTICAL SUSPENSIONS

- PORTA FRESE E TASTATORI
- PROTEZIONE AMPIA E MOBILE
- MOLLEGGIO VERTICALE

Door keys



Car keys



with adaptor
con adattatore

with adaptor
con adattatore

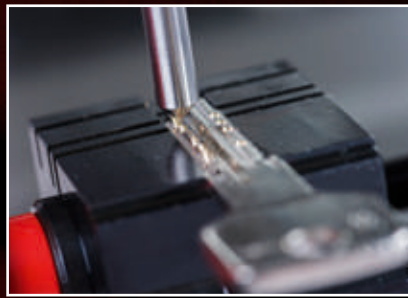
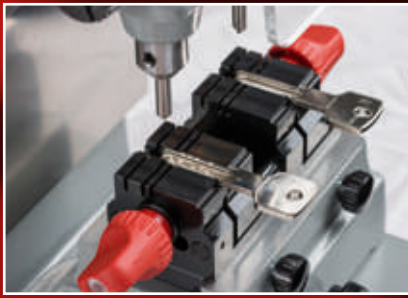

TECHNICAL FEATURES

Power Supply	230V 50Hz / 110V 60Hz
Lighting	Incandescent light bulb 25W
Movements/Axes	3 axes
Clamps	Fixed
Tracer	Hardened
Motor	Asynchronous, single speed
Cutter	HSS \varnothing 6 mm
Cutter Speed	9000 rpm
Absorption	200W
Dimensions	Width: 220 mm / Depth: 380 mm / Height: 380 mm
Weight	21 Kg

ACCESSORIES

MA	Adaptors for VAG keys
MK45	Adaptors for Kaba 45° keys
MK15	Adaptors for Kaba 15° keys
MK5	Adaptors for Keso 5° keys
MM	Adaptors for Mercedes car keys
MTB	Adaptors for Tibbe keys
MOMAX	Adaptors for Opel and Ford C-Max keys

CARATTERISTICHE TECNICHE

Alimentazione	230V 50Hz / 110V 60Hz
Illuminazione	Lampada a incandescenza 25W
Movimenti/Assi	3 assi
Morsetti	Fissi
Tastatore	Temprato
Motore	Asincrono, singola velocità
Fresa	HSS \varnothing 6 mm
Velocità Fresa	9000 rpm
Assorbimento	200W
Dimensioni	Larghezza: 220 mm / Profondità: 380 mm / Altezza: 380 mm
Peso	21 Kg

ACCESSORI

MA	Adattatori per chiavi VAG
MK45	Adattatori per chiavi Kaba 45°
MK15	Adattatori per chiavi Kaba 15°
MK5	Adattatori per chiavi Keso 5°
MM	Adattatori per chiavi Mercedes
MTB	Adattatori per chiavi Tibbe
MOMAX	Adattatori per chiavi Opel e Ford C-Max

ARCADIA

For tubular keys / Per chiavi tubolari



- WIDE AND MOVABLE PROTECTION SHIELD
- CLAMPS BAY
- COMPATIBLE WITH CLAMPS AVAILABLE ON THE MARKETS
- PROTEZIONE AMPIA E MOBILE
- VANO PORTA MORSETTI
- COMPATIBILE CON MORSETTI PRESENTI NEL MERCATO

Door keys

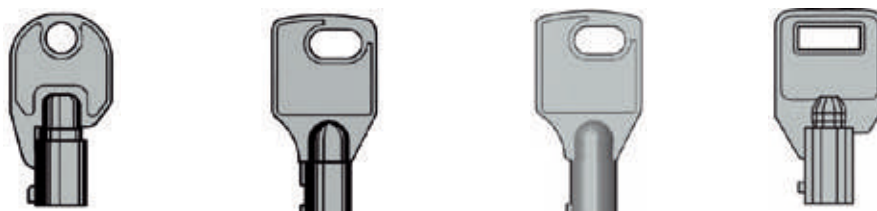

TECHNICAL FEATURES

Power Supply	110V 50Hz / 230V 50Hz
Lighting	LED - lighted cutting bay
Movements/Axes	2 axes
Clamps	More clamps for specific markets are available on demand
Tracer	Hardened
Motor	Asynchronous; 0.15 kW
Cutter	HSS \varnothing 5.95 mm
Cutter Speed	2800 rpm
Absorption	200W
Dimensions	Width: 210 mm / Depth: 400 mm / Height: 210 mm
Weight	12.5 Kg

ACCESSORIES

KT0	For Chicago, Meroni, P.C. Cortellezzi keys
KT2	For Progres, Fontaine and Corni keys
KT3	For Progres, Fontaine and Corni keys
KT4	For Vigie Picard keys
KT5	For Laperche keys
KT6	For JPM keys
KT7	For FTH and DAD-Decayeux keys
KT8	For Pollux keys
KT9	For Pollux keys
KT13	For Cavith keys



CARATTERISTICHE TECNICHE

Alimentazione	110V 50Hz / 230V 50Hz
Illuminazione	Area di lavoro illuminata a LED
Movimenti/Assi	2 assi
Morsetti	Morsetti per mercati specifici disponibili su richiesta
Tastatore	Temprato
Motore	Asincrono; 0,15 kW
Fresa	HSS \varnothing 5,95 mm
Velocità Fresa	2800 rpm
Assorbimento	200W
Dimensioni	Larghezza: 210 mm / Profondità: 400 mm / Altezza: 210 mm
Peso	12,5 Kg

ACCESSORI

KT0	Per chiavi Chicago, Meroni, P.C. Cortellezzi
KT2	Per chiavi Progres, Fontaine e Corni
KT3	Per chiavi Progres, Fontaine e Corni
KT4	Per chiavi Vigie Picard
KT5	Per chiavi Laperche
KT6	Per chiavi JPM
KT7	Per chiavi FTH e DAD-Decayeux
KT8	Per chiavi Pollux
KT9	Per chiavi Pollux
KT13	Per chiavi Cavith

FALCON

For special keys / Per chiavi speciali



- CLAMP WITH "EASY FIT" LOCKING
- CLAMP WITH 360° ROTATION
- STURDY AND HANDY
- MORSETTO CON CHIUSURA "EASY FIT"
- MORSETTO CON ROTAZIONE A 360°
- STABILE E MANEGGEVOLE

Door keys



Car keys



Ford and Jaguar
Ford e Jaguar



TECHNICAL FEATURES

Power Supply	110V 50Hz / 230V 50Hz
Movements/Axes	2 axes
Clamps	Clamps for specific markets are available on demand
Tracer	Cut by code
Motor	Asynchronous, single speed
Cutter	HSS ø 80 mm
Cutter Speed	1500 rpm
Brush	Tynex
Absorption	200W
Dimensions	Width: 400 mm / Depth: 370 mm / Height: 230 mm
Weight	17 Kg

ACCESSORIES

01	Clamp for Ford and Jaguar car keys
02	Clamp for Abus keys
03	Clamp for Abloy keys

CARATTERISTICHE TECNICHE

Alimentazione	110V 50Hz / 230V 50Hz
Movimenti/Assi	2 assi
Morsetti	Morsetti per mercati specifici disponibili su richiesta
Tastatore	Taglio a codice
Motore	Asincrono, singola velocità
Fresa	HSS ø 80 mm
Velocità Fresa	1500 rpm
Spazzola	Tynex
Assorbimento	200W
Dimensioni	Larghezza: 400 mm / Profondità: 370 mm / Altezza: 230 mm
Peso	17 Kg

ACCESSORI

01	Morsetto per chiavi auto Ford e Jaguar
02	Morsetto per chiavi Abus
03	Morsetto per chiavi Abloy

202 | 203

For bit keys and pump keys / Per chiavi a mappa e a pompa

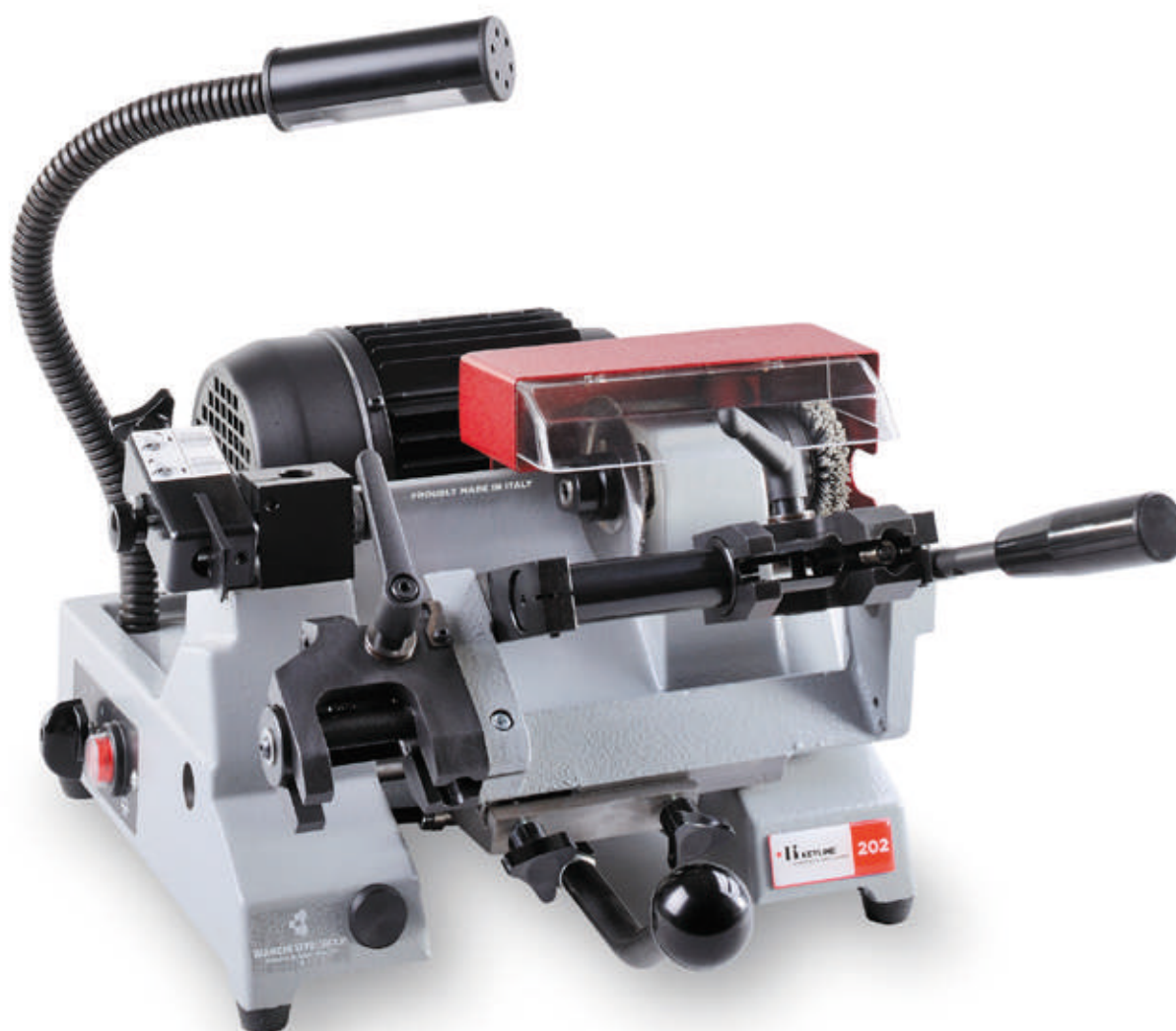

- SELF-CENTERING GRIPS (202)
- GANASCE AUTOCENTRANTI (202)
- CENTERING DEVICES (203)
- CENTRATORI (203)
- STURDY AND SILENT
- SOLIDA E SILENZIOSA

Door keys



only with 203
solo con 203

TECHNICAL FEATURES

MODEL	202	203
Version	Without centering devices	With centering devices
Power Supply	230V 50Hz	
Lighting	Incandescent light bulb 15W	
Movements/Axes	3 axes	
Clamps	Self-centring, made of tempered steel (more clamps are available on request)	Self-centring, made of tempered steel with countertops for female keys
Tracer	Hardened	
Motor	Asynchronous, two speed	
Cutter	HSS \varnothing 80x1.5 mm (more models are available on request)	HSS \varnothing 80x1.5 mm
Cutter Speed	350/700 rpm	
Brush	Tynex	
Absorption	400W	
Dimensions	Width: 380 mm / Depth: 450 mm / Height: 270 mm	
Weight	32 Kg	

CARATTERISTICHE TECNICHE

MODELLO	202	203
Versione	Senza centratori	Con centratori
Alimentazione	230V 50Hz	
Illuminazione	Lampada a incandescenza 15W	
Movimenti/Assi	3 assi	
Morsetti	Autocentranti in acciaio temprato (altri morsetti disponibili su richiesta)	Autocentranti in acciaio temprato con contropunte per chiavi femmina
Tastatore	Temprato	
Motore	Asincrono a due velocità	
Fresa	HSS \varnothing 80x1,5 mm (altri modelli disponibili su richiesta)	HSS \varnothing 80x1,5 mm
Velocità Fresa	350/700 rpm	
Spazzola	Tynex	
Assorbimento	400W	
Dimensioni	Larghezza: 380 mm / Profondità: 450 mm / Altezza: 270 mm	
Peso	32 Kg	



203

Version with centering device
Versione con centratori



204

For bit keys and pump keys / Per chiavi a mappa e a pompa



▪ SELF-CENTERING GRIPS

▪ MOVEMENT OF THE CARRIAGE
ON ROLL GUIDES

▪ STURDY AND SILENT

▪ GANASCE AUTOCENTRANTI

▪ MOVIMENTO DEL CARRELLO
SU GUIDE A RULLI

▪ SOLIDA E SILENZIOSA

Door keys



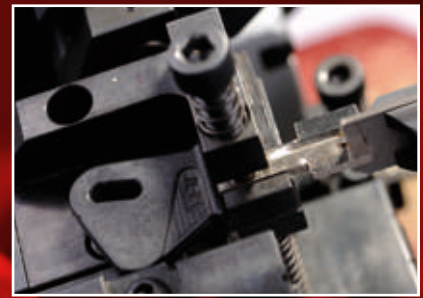

TECHNICAL FEATURES

Power Supply	230V 50Hz
Lighting	Incandescent light bulb 15W
Movements/Axes	On a cross-shaped table, thanks to roller guides
Clamps	For standard/double-bit male and female keys with self-centring tempered steel grips; for pump keys with round and square stem; for vertical cuts
Tracer	Hardened
Motor	Asynchronous, two speed
Cutter	HSS ϕ 80x1.5 mm
Cutter Speed	350/700 rpm
Absorption	400W
Dimensions	Width: 330 mm / Depth: 530 mm / Height: 390 mm
Weight	44 Kg

CARATTERISTICHE TECNICHE

Alimentazione	230V 50Hz
Illuminazione	Lampada a incandescenza 15W
Movimenti/Assi	Su tavola a croce tramite guide a rulli
Morsetti	Per chiavi mappa, doppia mappa maschio e femmina con ganasce autocentranti in acciaio temprato; per chiavi pompa con gambo sezione rotonda e quadra; per tagli verticali
Tastatore	Temprato
Motore	Asincrono a due velocità
Fresa	HSS ϕ 80x1,5 mm
Velocità Fresa	350/700 rpm
Assorbimento	400W
Dimensioni	Larghezza: 330 mm / Profondità: 530 mm / Altezza: 390 mm
Peso	44 Kg

206

For bit keys and pump keys / Per chiavi a mappa e a pompa



▪ **HANDY AND PRECISE**

▪ **MOVEMENT OF THE CARRIAGE
ON ROLL GUIDES**

▪ **STURDY AND SILENT**

▪ **MANEGGEVOLE E PRECISA**

▪ **MOVIMENTO DEL CARRELLO
SU GUIDE A RULLI**

▪ **SOLIDA E SILENZIOSA**

Door keys



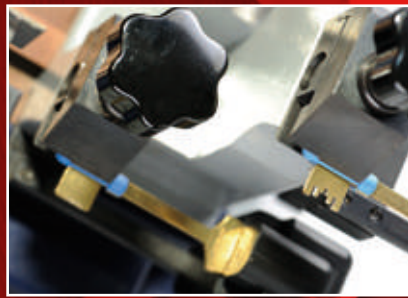

TECHNICAL FEATURES

Power Supply	230V 50Hz
Movements/Axes	On a cross-shaped table, thanks to roller guides
Clamps	Reversible for round stem and mailbox keys
Tracer	Hardened
Motor	Asynchronous, single speed
Cutter	First cutter: \varnothing 80x1.3 mm Second cutter: \varnothing 25x1.25 mm
Cutter Speed	First cutter: 500 rpm Second cutter: 1500 rpm
Absorption	400W
Dimensions	Width: 330 mm / Depth: 530 mm / Height: 390 mm
Weight	44 Kg

CARATTERISTICHE TECNICHE

Alimentazione	230V 50Hz
Movimenti/Assi	Su tavola a croce tramite guide a rulli
Morsetti	Reversibili per chiavi con gambo sezione rotonda e chiavi per casellari postali
Tastatore	Temprato
Motore	Asincrono singola velocità
Fresa	Prima fresa: \varnothing 80x1,3mm Seconda fresa: \varnothing 25x1,25mm
Velocità Fresa	Prima fresa: 500 rpm Seconda fresa: 1500 rpm
Assorbimento	400W
Dimensioni	Larghezza: 330 mm / Profondità: 530 mm / Altezza: 390 mm
Peso	44 Kg

884 DECRYPTOR MINI

For electronic keys, remote controls and keyless systems /
Per chiavi elettroniche, telecomandi e sistemi keyless



- MAXIMUM CALCULATION POWER
- LIMITLESS CONNECTIVITY
- MINIMUM FOOTPRINT
- AFFORDABLE PRICE



- MASSIMA POTENZA DI CALCOLO
- CONNETTIVITÀ SENZA LIMITI
- MINIMO INGOMBRO
- PREZZO EASY

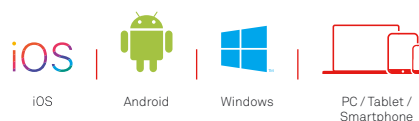

Car key cloning made easy, with extreme calculation power and an unparalleled low price.

884 Decryptor Mini is simple to use: just connect it to your Android smartphone or tablet with USB-OTG capability or to a PC Windows (7 and subsequent versions) with an Internet connection, download the **Keyline Cloning Tool mobile App*** from Google Play Store or the PC Software from the website www.keyline.it or www.keyline-usa.com and start the transponder-equipped car key automatic cloning procedure, without having to press any buttons and also without connecting to a power outlet.

Its extremely high calculation power, maximum flexibility and ease of use make it the ideal choice for professionals in the key business.

884 Decryptor Mini can be equipped with Bluetooth & Power Adaptor, the next-generation rechargeable battery with Bluetooth technology to use 884 Decryptor Mini wirelessly. With Bluetooth & Power Adaptor, 884 Decryptor Mini can be managed from any Windows PC, smartphone and tablet, Android and iOS**, thus offering an unlimited cloning service.

La clonazione di chiavi auto con una maneggevolezza unica per una potenza di calcolo estrema e un prezzo senza paragoni.

884 Decryptor Mini è semplice da usare: basta collegarla al proprio smartphone o tablet dotato di sistema operativo Android provvisto di funzionalità USB-OTG oppure al PC Windows (7 e successivi) connesso a Internet, scaricare la **App Keyline Cloning Tool*** da Google Play Store o il Software per PC dal sito www.keyline.it o www.keyline-usa.com, e avviare la procedura di clonazione in automatico di chiavi auto con transponder, senza premere nemmeno un pulsante e senza collegarsi alla presa elettrica. La sua estrema potenza di calcolo, la massima versatilità e semplicità d'uso la rendono la scelta ideale a portata di tutti i professionisti del key business.

884 Decryptor Mini può essere dotata di Bluetooth & Power Adaptor, la batteria ricaricabile di ultima generazione con tecnologia Bluetooth per utilizzare il dispositivo in modalità wireless, senza l'ausilio dei cavi di connessione. Con Bluetooth & Power Adaptor, 884 Decryptor Mini può essere gestita da qualsiasi PC Windows, smartphone e tablet, sia Android che iOS**, offrendo così un servizio di clonazione illimitato.

884 Decryptor Mini requires always internet connection.

* Keyline Cloning Tool mobile App must be used only with 884 Decryptor Mini.

** The iOS version is available exclusively with the use of Bluetooth & Power Adaptor.

884 Decryptor Mini richiede sempre la connessione internet.

* La App Keyline Cloning Tool è da utilizzarsi esclusivamente con 884 Decryptor Mini.

** La versione per iOS è disponibile esclusivamente con l'utilizzo della batteria Keyline Bluetooth & Power Adaptor.



Transponder cloning:

- Texas® fixed code
- Texas® Crypto
- Texas® 80-bit
- Philips® fixed code
- First generation Philips® Crypto*
- Second generation Philips® Crypto
- Megamos® fixed code
- Megamos® Crypto** (to be activated with TKM. Xtreme Kit)
- Megamos® Crypto (for Kia, Chevrolet - Daewoo, Pontiac)
- Keyline Keyless Kit
- Keyline RFD100

Clonazione transponder:

- Texas® codice fisso
- Texas® Crypto
- Texas® 80-bit
- Philips® codice fisso
- Philips® Crypto di prima generazione*
- Philips® Crypto di seconda generazione
- Megamos® codice fisso
- Megamos® Crypto** (da attivare con TKM. Xtreme Kit)
- Megamos® Crypto (per Kia, Chevrolet - Daewoo, Pontiac)
- Keyline Keyless Kit
- Keyline RFD100

TECHNICAL FEATURES

Power Supply	5V
External Connections	USB
Absorption	500mA
Connectivity	USB
Dimensions	Width: 120 mm / Depth: 100 mm / Height: 90 mm
Weight	200 gr

CARATTERISTICHE TECNICHE

Alimentazione	5V
Connessioni Esterne	USB
Assorbimento	500mA
Connettività	USB
Dimensioni	Larghezza: 120 mm / Profondità: 100 mm / Altezza: 90 mm
Peso	200 gr

All the brands and trade marks mentioned here are the exclusive property of the respective car manufacturers or groups.
 * Regarding first generation Philips® Crypto transponder, 884 Decryptor Mini can clone some PH1A; but not PH1D and also Keyline RK50 remote controls.
 ** In order to clone TKM-supported Megamos® Crypto transponders, the 884 Decryptor Mini must be activated through the TKM. Xtreme Kit. For a complete list of models that can be cloned to date, please consult the TKM. Xtreme Kit page. To get information on prices, please contact your area sales agent or the nearest distributor.

Tutti i marchi e i marchi di fabbrica qui pubblicati sono marchi registrati e di esclusiva proprietà delle rispettive case o gruppi automobilistici.
 * Circa i transponder Philips® Crypto di prima generazione 884 Decryptor Mini è in grado di clonare alcuni transponder PH1A; non sono clonabili transponder PH1D e i radiocomandi Keyline RK50.
 ** Per effettuare la clonazione dei transponder Megamos® Crypto supportati da TKM, 884 Decryptor Mini deve essere attivata tramite TKM. Xtreme Kit. Per consultare la lista completa di modelli ad ora clonabili si veda la pagina di TKM. Xtreme Kit. Per essere informati sui prezzi, si prega di rivolgersi direttamente al proprio agente di zona o al distributore più vicino.

BLUETOOTH & POWER ADAPTOR

For 884 Decryptor Mini / Per 884 Decryptor Mini



- STABLE AND LONG-LASTING CHARGE
- WIRELESS CLONING SERVICE
- IMMEDIATELY USABLE WITH THE KEYLINE CLONING TOOL APP FOR IOS AND ANDROID
- CHARGING VIA PC CONNECTION OR THROUGH BATTERY CHARGER
- CARICA STABILE E DI LUNGA DURATA
- SERVIZIO DI CLONAZIONE WIRELESS
- UTILIZZO IMMEDIATO CON LA APP KEYLINE CLONING TOOL PER IOS E ANDROID
- RICARICA TRAMITE CONNESSIONE A PC O TRAMITE CARICA BATTERIA DA RETE

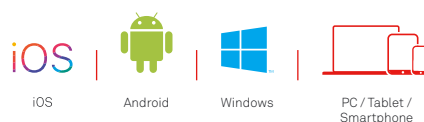

Keyline **Bluetooth & Power Adaptor** is the next-generation rechargeable battery with Bluetooth technology to use 884 Decryptor Mini wirelessly, without the aid of connecting cables. With Bluetooth & Power Adaptor, 884 Decryptor Mini can be managed from any smartphone and tablet*, Android and iOS.

* 884 Decryptor Mini with Bluetooth & Power Adaptor can also be used with PC (Windows).

Bluetooth & Power Adaptor di Keyline è la batteria ricaricabile di ultima generazione con tecnologia Bluetooth per utilizzare 884 Decryptor Mini in modalità wireless, senza l'ausilio dei cavi di connessione.

Con Bluetooth & Power Adaptor, 884 Decryptor Mini può essere gestita da qualsiasi PC Windows, smartphone e tablet*, sia Android che iOS.

* 884 Decryptor Mini con Bluetooth & Power Adaptor può essere utilizzata anche con PC (Windows).



884 DECRYPTOR ULTEGRA

For electronic keys, remote controls and keyless systems /
Per chiavi elettroniche, telecomandi e sistemi keyless



- INTUITIVE MULTI-LANGUAGE GRAPHIC DISPLAY
- DISPLAY GRAFICO INTUITIVO E MULTILINGUA
- VIRTUALLY UNLIMITED POSSIBILITIES OF EXPANSION
- POSSIBILITÀ DI ESPANSIONE VIRTUALMENTE ILLIMITATE
- EXTREMELY FAST DUPLICATION
- ESTREMA VELOCITÀ DI DUPLICAZIONE

The **884 Decryptor Ultegra** device is Keyline's solution for the cloning of electronic keys and remote controls.

Its advanced computing power, ease of use and versatility guaranteed by easy and quick updates, make this the ideal choice for specialists in the automotive technology sector.

Il dispositivo **884 Decryptor Ultegra** è la soluzione Keyline per la clonazione delle chiavi elettroniche e telecomandi.

La sua estrema potenza di calcolo, unita alla grande semplicità d'uso e alla versatilità garantita da una facile e veloce procedura di aggiornamento, la rendono la scelta ideale per lo specialista nel campo dell'automotive technology.

* All the brands and trade marks mentioned here are the exclusive property of the respective car manufacturers or groups.
** In order to clone Texas® 80-bit transponders, the 884 Decryptor Ultegra requires internet connection.
*** In order to clone TKM-supported Megamos® Crypto transponders the 884 Decryptor Ultegra requires internet connection and must be activated through the TKM. Xtreme Kit.

* Tutti i marchi e i marchi di fabbrica qui pubblicati sono marchi registrati e di esclusiva proprietà delle rispettive case o gruppi automobilistici.
** Per effettuare la clonazione dei transponder Texas® 80 bit, 884 Decryptor Ultegra deve essere connessa a internet.
*** Per effettuare la clonazione dei transponder Megamos® Crypto supportati da TKM, 884 Decryptor Ultegra deve essere attivata tramite TKM. Xtreme Kit e connessa a internet.



Transponder cloning*

- Stand-alone cloning for Philips® Crypto 1st Generation transponders.
- Cloning in stand alone mode for fixed code transponders.
- Stand-alone cloning for Texas® Crypto transponders using Keyline TK100 electronic heads, GK100 glass chips or CK100 carbon chips.
- Cloning of a part of the Texas® 80-bit** transponders using TK100 electronic heads or CKG carbon chips.
- Stand-alone cloning for Philips® Crypto 1st Generation transponders ID45 VAG-Ford, ID 4W Peugeot, ID42 Volkswagen and Seat.
- Stand-alone cloning for Philips® Crypto 2nd Generation transponder using TK100, GK100 or CK100.
- Cloning for Megamos® Crypto*** transponders using TKM electronic heads or GKM glass chips.
- Programming of fixed code transponder through the manual entry of ID.
- Automatic generation of some codes for fixed code transponder.
- Stand-alone cloning for Megamos® Crypto transponders for Kya, Chevrolet-Daewoo and Pontiac.

Remote control cloning

- Built-in radio frequency station for cloning Philips® Crypto 2nd generation remote control through the RK60, the new Keyline electronic head equipped with remote control. The RK60 is fully compatible with all Keyline horseshoe blades that are used with Philips® Crypto 2nd generation equipped vehicles.
- RFD100 and RFD80 models for Ford remote keys. Clonable with the 884 Decryptor Ultegra (RFD100) or entirely on-board programmable (RFD80), they guarantee perfect synchronization with the original Ford remote without altering the functionality.

Other functions

- Multi-functional alphanumeric keypad.
- RS232 & USB connection.
- Graphical display.
- Self antenna for all transponder types.
- 12V cigarette lighter adaptor for use directly in the vehicle.

TECHNICAL FEATURES

Power Supply	DC 12V; power adapter included
External Connections	RS232 and USB serial ports
Absorption	20W
Dimensions	Width: 220 mm / Depth: 130 mm / Height: 70 mm
Weight	1 Kg

Clonazione transponder*

- Clonazione di transponder Philips® Crypto di prima generazione.
- Clonazione di tutti i tipi di transponder a codice fisso.
- Clonazione di transponder Texas® Crypto tramite il TK100, il GK100 o il CK100.
- Clonazione di parte dei transponder Texas® 80 bit** tramite TK100 o CKG.
- Clonazione di transponder Philips® Crypto di prima generazione ID45 VAG-Ford, ID 4W Peugeot, ID42 Volkswagen e Seat.
- Clonazione di transponder Philips® Crypto di seconda generazione tramite il TK100, il GK100 o il CK100.
- Clonazione di transponder Megamos® Crypto*** tramite il TKM o il GKM.
- Programmazione transponder a codice fisso tramite inserimento manuale ID.
- Generazione automatica di alcuni codici per transponder a codice fisso.
- Clonazione di transponder Megamos® Crypto per Kya, Chevrolet-Daewoo e Pontiac.

Clonazione telecomandi

- Stazione radio incorporata per clonazioni di telecomandi dei veicoli equipaggiati con transponder Philips® Crypto di II generazione tramite RK60, la nuova testa elettronica Keyline dotata di telecomando. RK60 è compatibile con tutti gli Horseshoe Keyline impiegati nei veicoli equipaggiati con transponder Philips® Crypto di II generazione.
- Modelli RFD100 e RFD80 per telecomandi Ford. Clonabili con 884 Decryptor Ultegra (RFD100) o programmabile a bordo veicolo (RFD80), garantiscono la sincronizzazione perfetta con il telecomando Ford originale, senza alterarne il funzionamento.

Altre funzioni

- Tastiera alfanumerica multifunzione.
- Connessioni RS232 e USB.
- Display grafico multilingua.
- Stessa antenna per tutti i tipi di transponder.
- Adattatore per alimentazione nel veicolo tramite presa accendisigari.

CARATTERISTICHE TECNICHE

Alimentazione	DC 12V; alimentatore universale incluso
Connessioni Esterne	Porta USB e seriale RS232
Assorbimento	20W
Dimensioni	Larghezza: 220 mm / Profondità: 130 mm / Altezza: 70 mm
Peso	1 Kg

KEYLINE KEYLESS SYSTEMS

Thanks to its proven technology for Megamos® Crypto (ID48) transponder cloning and TK100, the universal electronic head, Keyline leads the way towards Keyless Systems.

The coupling of an electronic head and a mechanical key makes it possible to duplicate the BMW, Volvo, Volkswagen, Toyota, Kia, Hyundai, Nissan, Infiniti, Jeep, Ram, Chrysler and Dodge systems easily and accurately. Keyline's research and development innovation is at the roots of these products that enhance the Keyline range in the field of automotive technology.



BMW Kit

Code: **BM100KIT**



MODEL	FROM	TO
SERIES 1	2007	2010
SERIES 3	2005	2011
SERIES 5	2004	2010
SERIES 6	2004	2010
X1	2009	2011
X5	2007	2011



Volvo Kit

Code: **VL100KIT**



MODEL	FROM	TO
V70	2008	2011
XC70	2008	2011
S80	2008	2011

Keyline, grazie alla consolidata tecnologia Keyline per la clonazione dei transponder Megamos® Crypto, e del TK100, la testa elettronica universale, apre la nuova frontiera dei sistemi Keyless.

L'accoppiata di testa elettronica e chiave meccanica permette di duplicare i sistemi BMW, Volvo, Volkswagen, Toyota, Kia, Hyundai, Nissan, Infiniti, Jeep, Ram, Chrysler e Dodge con facilità e precisione. L'innovazione nella ricerca e nello sviluppo di Keyline è alla base di questi prodotti, che arricchiscono la gamma di Keyline nell'ambito dell'automotive technology.



Toyota Prius Kit

Code: **TR100KIT**



MODEL	FROM	TO
PRIUS	2004	2009

Toyota Yaris Kit

Code: **TRY100KIT**



MODEL	FROM	TO
YARIS*	2010	2012

*Available only for certain fittings.
*Disponibile solo per alcuni allestimenti.



All brands and trademarks published here are exclusive property of the relevant car makers or groups. Tutti i marchi e i marchi di fabbrica qui pubblicati sono di esclusiva proprietà delle rispettive case o gruppi automobilistici.

KEYLINE KEYLESS SYSTEMS

Universal Kit Code: UNIVERSAL100KIT



The new Universal Kit has crossed the threshold of automotive duplication. Actually, the kit has been devised for universal use, as for instance, entrance control systems in the home environment, so that the end user can enjoy a remarkable degree of utilization flexibility. This new kit can be utilized in any type of application featuring a transponder that can be cloned with Keyline's 884 Decryptor Mini and 884 Decryptor Ultegra machines. The kit comes in a practical format featuring the TK100UN device and a handy key-ring.

Con il nuovo Universal Kit sono stati superati i confini della duplicazione automotive. Questo kit infatti è stato ideato per usi generici, permettendo così all'utente finale una versatilità di utilizzo notevole. In qualsiasi tipo di applicazione in cui è presente un transponder clonabile con 884 Decryptor Mini o con 884 Decryptor Ultegra potete utilizzare questo nuovo kit. Lo potete ricevere in un pratico formato che include il dispositivo TK100UN e un comodo anello portachiavi.



New Volvo Kit Code: VLMKIT*



MODEL	FROM	TO
C30	2008	Today
S40	2008	Today
S80	1999	Today
V40	2012	Today
V50	2004	Today

*For this Kit, the Keyline cloning device must be activated through the TKM. Xtreme Kit.
*Per questo Kit, è necessario attivare i dispositivi di clonazione Keyline con TKM. Xtreme Kit.



Kia and Hyundai Kit Code: KIHY100KIT



MAKE	MODEL	FROM	TO
Kia	SORENTO	2010	2012
	SPORTAGE	2010	2012
	CEED*	2011	Today
	SOUL*	2011	Today
Hyundai	SANTA FE	2011	2012
	SONATA	2011	Today

*Available only for certain fittings.
*Disponibile solo per alcuni allestimenti.



Chrysler, Dodge, Jeep, Ram Kit Code: **Y100KIT**



MAKE	MODEL	FROM	TO
Chrysler	300, 300C	2008	2010
	TOWN & COUNTRY	2008	2013



Dodge	CHALLENGER	2008	2012
	CHARGER	2008	2010
	DART	2013	2013
	DURANGO	2011	2012
	GRAND CARAVAN	2008	2013



Jeep	COMMANDER	2013	2013
	GRAND CHEROKEE	2006	2007
	GRAND CHEROKEE	2008	2010



Ram	1500	2011	2012
	2500, 3500 HEAVY DUTY	2006	2010
	3500, 4500, 5500 CHASSIS CAB	2011	2011



Nissan Kit Code: **NS100KIT**



MAKE	MODEL	FROM	TO
Infiniti	EX35	2008	2012
	FX35	2009	2012
	FX50	2009	2012
	G25	2011	2012
	G37 2DR	2008	2011
	G37 4DR	2009	2012
	JX35	2013	2013
	M35	2006	2007
	M35	2006	2007
	M35	2008	2010
	M37	2011	2012
	M45	2006	2010



Nissan	370Z	2009	2013
	ALTIMA 2DR	2007	2013
	ALTIMA 4DR	2007	2012
	ALTIMA 4DR	2013	2013
	CUBE	2009	2011
	JUKE	2011	2013
	LEAF	2011	2013
	MAXIMA	2009	2013
	MURANO	2009	2012
	PATHFINDER	2013	2013
	QUEST	2013	2013
	SENTRA	2013	2013



Volkswagen Kit Code: **VWMKIT***



MODEL	FROM	TO
PASSAT	2006	2013

*For this Kit, the Keyline cloning device must be activated through the TKM. Xtreme Kit.
*Per questo Kit, è necessario attivare i dispositivi di clonazione Keyline con TKM. Xtreme Kit.

KEYLINE TV

The channel dedicated to locksmiths on the Keyline website /
Sul sito Keyline la televisione dedicata ai locksmiths

It's the TV channel dedicated to Keyline's world, with stories from five continents, interviews and news. All the tutorials of the key cutting machines and the cloning devices are available on a dedicated page.

It's a real online training with lots of videos that show in a clear and precise way all the procedures.

To access Keyline TV you just need to visit the page with the same name on the website or the YouTube channel.

È il canale TV dedicato al mondo Keyline, con servizi dai cinque continenti, interviste e notizie. E sull'apposita pagina, sono disponibili tutti i tutorial delle macchine duplicatrici e dei dispositivi di clonazione.

È una vera e propria formazione online con tantissimi video che mostrano in modo chiaro e preciso tutte le procedure.

Per accedere a Keyline TV basta visitare l'omonima pagina del sito o il canale YouTube.



The video archive of key cutting machines and cloning devices tutorials is online
Online la videoteca dei tutorial sulle duplicatrici e sui dispositivi di clonazione



<https://www.keyline.it/it/keyline-tv>

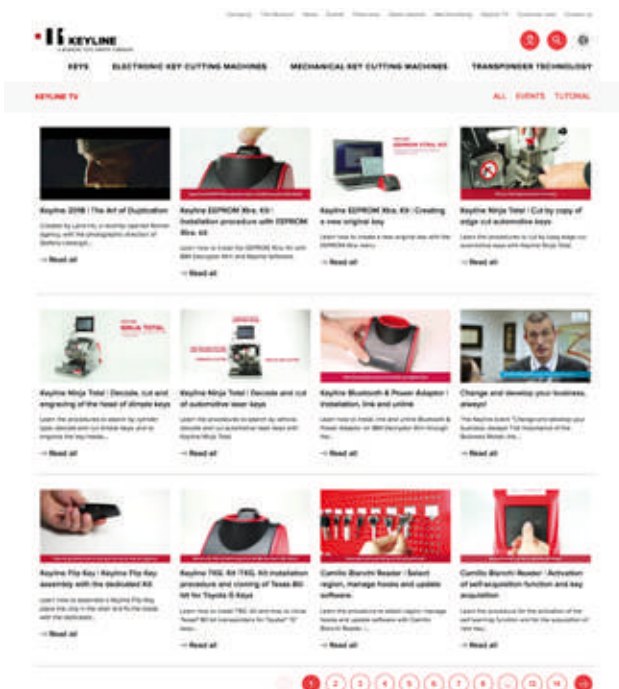

KEYCENTER



SINGLE PIECES

KC201	Varnished piece of furniture with 5 drawers
KC101-EU	Hook panel with new led light and EU plug
KC101-USA-JAP	Hook panel with new led light and USA/JAP plug
KC101-AUS	Hook panel with new led light and AUS plug
KC101-UK	Hook panel with new led light and UK plug
KC301	Varnished piece of furniture with a hinged door and a drawer
KC301/S	Varnished piece of furniture with a hinged door and a drawer with lock
KC102	Display window
KC025	Riser for key cutting machines
KC010	Handle with screws
GA070	Single nickel hook 70 mm (box 50 pcs)
GA090	Single nickel hook 90 mm (box 50 pcs)

PEZZI SINGOLI

KC201	Modulo con 5 cassetti
KC101-EU	Pannello ganci con luci a LED e presa EU
KC101-USA-JAP	Pannello ganci con luci a LED e presa USA-JAP
KC101-AUS	Pannello ganci con luci a LED e presa AUS
KC101-UK	Pannello ganci con luci a LED e presa UK
KC301	Modulo con cassetto e anta
KC301/S	Modulo con cassetto e anta con serratura
KC102	Vetrina
KC025	Piattaforma rialzata per duplicatrici
KC010	Maniglia di ricambio con viti
GA070	Gancio nichelato da 70 mm
GA090	Gancio nichelato da 90 mm

Keycenter is the ideal furnishing solution for your shop. Its modular design makes it possible for you to choose your furnishings according to your needs. You can choose between preassembled kits and individual modules: support structures for your key cutting machines, halogen lights to brighten the work area, panels with hooks and cabinets and drawer units to keep your keys and work tools in order.

Keycenter è la soluzione d'arredo ideale per il vostro punto vendita. La sua natura modulabile permette di comporre il vostro mobile sulla base delle vostre esigenze. Potete scegliere tra kit preassemblati o singoli moduli: piani d'appoggio per le vostre duplicatrici, faretto alogeni per illuminare la zona di lavoro, pannelli con ganci e mobili ad ante e con cassetti per ordinare le vostre chiavi e i vostri strumenti di lavoro.

Examples of modularity
Esempi di composizione

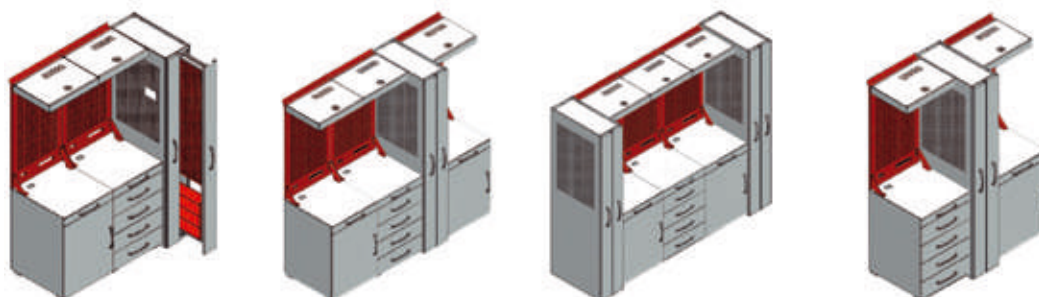

To get information on the dimensions, please consult the Keycenter page on the www.keyline.it website
Per essere informati sulle dimensioni, si veda la pagina dei Keycenter sul sito www.keyline.it

MODULAR KITS







KC100	KEYCENTER 1 - Stock piece of furniture with 4 shelves in the lower part and drilled walls
KC200-EU	KEYCENTER 2 - Modular kit composed of a piece of furniture with 5 drawers and a hook panel with new led light and EU plug (KC101-EU + KC 201)
KC200-USA-JAP	KEYCENTER 2 - Modular kit composed of a piece of furniture with 5 drawers and a hook panel with new led light and USA/JAP plug (KC101-USA-JAP + KC 201)
KC200-AUS	KEYCENTER 2 - Modular kit composed of a piece of furniture with 5 drawers and a hook panel with new led light and AUS plug (KC101-AUS + KC 201)
KC200-UK	KEYCENTER 2 - Modular kit composed of a piece of furniture with 5 drawers and a hook panel with new led light and UK plug (KC101-UK + KC 201)
KC300-EU	KEYCENTER 3 - Modular kit composed of a piece of furniture with a drawer, a hinged door and a hook panel with new led light and EU plug (KC101-EU + KC 301)
KC300-USA-JAP	KEYCENTER 3 - Modular kit composed of a piece of furniture with a drawer, a hinged door and a hook panel with new led light and USA/JAP plug (KC101-USA-JAP + KC 301)
KC300-AUS	KEYCENTER 3 - Varnished preassembled kit composed of a piece of furniture with a drawer, a hinged door, and a hook panel with new led light and AUS plug (KC101-AUS + KC 301)
KC300-UK	KEYCENTER 3 - Modular kit composed of a piece of furniture with a drawer, a hinged door and a hook panel with new led light and UK plug (KC101-UK + KC 301)
KC210	Varnished preassembled kit composed of a piece of furniture with 5 drawers and an upper display window (KC102 + KC201)
KC310	Varnished preassembled kit composed of a piece of furniture with drawer, hinged door and upper display window (KC102 + KC301)

KIT PREASSEMBLATI

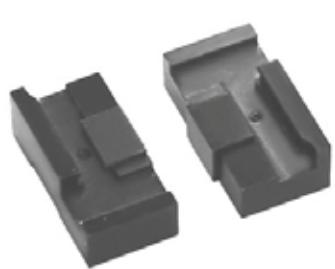
KC100	KEYCENTER 1 - Modulo di stoccaggio con 4 mensole nella parte inferiore e pareti esterne forate
KC200-EU	KEYCENTER 2 Kit preassemblato in metallo verniciato composto da modulo con 5 cassetti, pannello ganci con luci a LED e presa EU (KC101-EU + KC 201)
KC200-USA-JAP	KEYCENTER 2 Kit preassemblato in metallo verniciato composto da modulo con 5 cassetti, pannello ganci con luci a LED e presa USA-JAP (KC101-USA-JAP + KC 201)
KC200-AUS	KEYCENTER 2 Kit preassemblato in metallo verniciato composto da modulo con 5 cassetti, pannello ganci con luci a LED e presa AUS (KC101-AUS + KC 201)
KC200-UK	KEYCENTER 2 Kit preassemblato in metallo verniciato composto da modulo con 5 cassetti, pannello ganci con luci a LED e presa UK (KC101-UK + KC 201)
KC300-EU	KEYCENTER 3 Kit preassemblato in metallo verniciato composto da modulo con cassetto, anta e pannello ganci con luci a LED e presa EU (KC101-EU + KC 301)
KC300-USA-JAP	KEYCENTER 3 Kit preassemblato in metallo verniciato composto da modulo con cassetto, anta e pannello ganci con luci a LED e presa USA-JAP (KC101-USA-JAP + KC 301)
KC300-AUS	KEYCENTER 3 Kit preassemblato in metallo verniciato composto da modulo con cassetto, anta e pannello ganci con luci a LED e presa AUS (KC101-AUS + KC 301)
KC300-UK	KEYCENTER 3 Kit preassemblato in metallo verniciato composto da modulo con cassetto, anta e pannello ganci con luci a LED e presa UK (KC101-UK + KC 301)
KC210	Kit preassemblato composto da modulo con 5 cassetti e vetrina superiore (KC102 + KC201)
KC310	Kit preassemblato composto da modulo con anta e cassetto e vetrina superiore (KC102 + KC301)

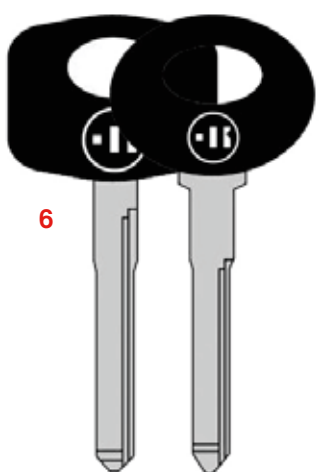
To get information on the dimensions, please consult the Keycenter page on the www.keyline.it website
Per essere informati sulle dimensioni, si veda la pagina dei Keycenter sul sito www.keyline.it

TECHNICAL ILLUSTRATIONS AND SYMBOLS | ILLUSTRAZIONI TECNICHE E SEGNI CONVENZIONALI

TO FIT :		1 MERCEDES (D)				
<p>OPTIONAL 2</p> <p>MM 3 Morsetti per chiavi Mercedes Jaws for Mercedes keys Spannbacken für Mercedes-Schlüssel Étaux pour clés Mercedes Mordazas para llaves Mercedes</p> 		<p>5</p> <p>T-REX T-REX ADVANCE</p>  <p>PUNTO</p> 		<p>6</p>  <p>7</p> <p>MB57P MB54P MB41P</p>  <p>8</p> <p>PROTECTED SYSTEM</p> 		
<p>STANDARD 2</p> <p>4</p> <p>RIC01810B Fresino HC011 Cutter HC011 Fräser HC011 Fraise HC011 Fresa HC011</p>  <p>2.5 mm</p> <p>RIC01811B Tastatore C011 Tracer Point C011 Taster C011 Palpeur C011 Palpador C011</p> 						

1
 Marca principale
 Main brand
 Hauptmarke
 Marque principale
 Marca principal

2
 Attrezzatura (di serie/non di serie) per la duplicazione
 Equipment (standard/optional) for the duplication
 Gerät (standard/optionale) für die Kopie
 Équipement (standard/optionnel) pour la duplication
 Equipo (de serie/opcionales) para la duplicación

3
 Codice e descrizione accessorio
 Accessory code and description
 Artikelnr. und Zubehörsbeschreibung
 Code et description de l'accessoire
 Código y descripción del accesorio

4
 Caratteristiche fresa
 Cutter specifications
 Fräuserspezifikation
 Caractéristiques de la fraise
 Datos fresa

5
 Macchine duplicatrici
 Key cutting machines
 Schlüsselkopiermaschinen
 Machines à tailler
 Máquinas duplicadoras

6
 Chiave
 Key
 Schlüssel
 Clé
 Llave

7
 Articolo
 Article
 Artikel
 Article
 Artículo

8
 Sistema protetto
 Protected system
 Geschütztes System
 Système protégé
 Sistema protegido

SYMBOLS | SIMBOLOGIE

OPTIONAL Accessorio/accessori non di serie
Optional accessory/accessories
Optionale Zubehör/Zubehöre
Accessoire/accessoires optionaux
Accesorio/accesorios opcionales

STANDARD Accessorio/accessori di serie
Standard accessory/accessories
Standard Zubehör/Zubehöre
Accessoire /accessoires standard
Accesorio/accesorios de serie



Chiavi cilindro
Cylinder keys
Zylinderschlüssel
Clés pour cylindres
Llaves cilindro



Chiavi auto e accessori
Car keys and accessories
Auto-Schlüssel und Zubehör
Accessoires et clés pour voitures
Llaves para auto y accesorios



Chiavi per camion e accessori
Truck keys and accessories
LKW-Schlüssel und Zubehör
Accessoires et clés pour camion
Llaves para camión y accesorios



Chiavi patent
Cold forged keys
Patentschlüssel
Clés à patent
Llaves patent



Chiavi a doppia mappa e pompa
Double bit and pump keys
Doppelbart-Pumpenschlüssel
Clés à double panneton et pompe
Llaves a doble paletón y pompa



Chiavi a croce
Cruciform keys
Kreuzbartschlüssel
Clés cruciformes
Llaves a cruz



Chiavi per casellari postali
Mail box keys
Kastenschlüssel
Clés pour casiers
Llaves de buzón



Guida veloce ai sistemi chiavi laser
Quick guide to laser key systems
Kurzanleitung für Laser-Schlüssel Systeme
Guide rapide des systemes de clés laser
Guía rápida a los sistemas llaves láser



Frese
Cutters
Fräser
Fraises
Fresas



Fresino a punta
Angle tip cutter
Spitzfräser
Fraise pointu
Fresa de punto



Fresino gambo cilindrico
Cylindrical milling cutter
Bahnenfräser
Fraise cylindrique
Fresa cilíndrica

CHIAVI CILINDRO

CYLINDER KEYS

ZYLINDERSCHLÜSSEL

CLÉS POUR SERRURES À CYLINDRE

LLAVES PARA CERRADURAS A CILINDRO



TO FIT: **ABLOY (S)**



AB1

AB1P



Abloy Profile

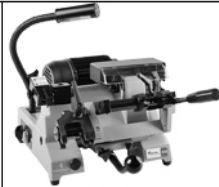

202



203



**POWER LYNX
SIGMA PRO**

OPTIONAL

CSA

*Carrello per chiavi Abloy
Carriage for Abloy keys
Schlitten für Abloy-Schlüssel
Chariot pour clés Abloy
Carro para llaves de Abloy*



T3P

*Tastatore 3 posizioni
3 position tracer
3 Positions-Taster
Palpeur 3 positions
Palpador 3 posiciones*



T3P/COD

*Tastatore 3 posizioni a codice
3 position code cutting tracer
Verstellbarer 3 Positionen Taster
Palpeur 3 positions à code
Palpador de 3 posiciones con código*



OPTIONAL

OPZ05311B

*Morsetto 09 per chiavi Abloy
Jaw 09 for Abloy keys
Spannbacke 09 für Abloy-Schlüssel
Étau 09 pour clés Abloy
Mordaza 09 para llaves Abloy*

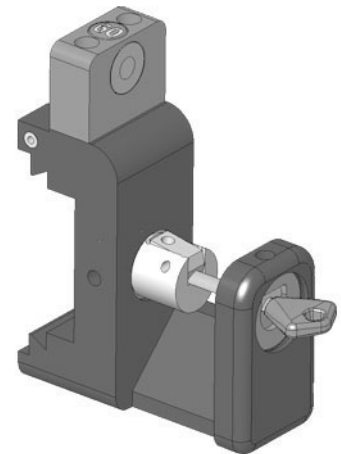

TO FIT: **ABLOY (S)**



AB1P



FALCON

OPTIONAL

OPZ08773B

*Morsetto 03 per chiavi Abloy
Jaw 03 for Abloy keys
Spannbacke 03 für Abloy Schlüssel
Étau 03 pour clés Abloy
Mordaza 03 para llaves Abloy*



TO
FIT :

ABLOY (S)

OPZ08120B
Morsetto C17
Jaw C17
Spannbacke C17
Étau C17
Mordaza C17
OPTIONAL



VERSA

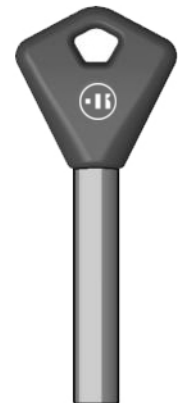

AB1P

2.50 mm
RIC05048B
Fresino V003
Cutter V003
Fräser V003
Fraise V003
Fresa V003
STANDARD

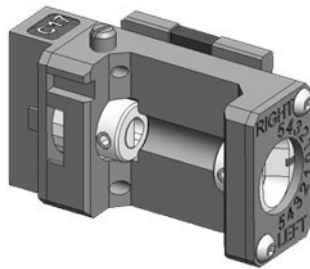

TO
FIT :

ABLOY (S)

OPTIONAL

OPZ09416B
Morsetto 04 per chiavi Abloy
Jaw 04 for Abloy keys
Spannbacke 04 für Abloy-Schlüssel
Étau 04 pour clés Abloy
Mordaza 04 para llaves Abloy

RIC01868B
Fresa HSSG10
Cutter HSSG10
Fräser HSSG10
Fraise HSSG10
Fresa HSSG10

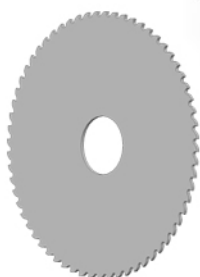

FALCON

EXEC



TO
FIT: **ABLOY (S)**

**Protec
Protec 2**

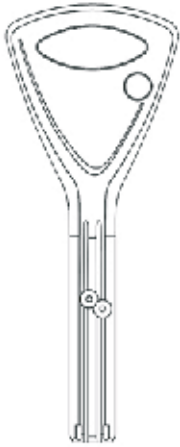

SIGMA PRO

OPTIONAL



RIC06716B
*Fresa WSPL
Cutter WSPL
Fräser WSPL
Fraise WSPL
Fresa WSPL*

OPZ10432B
*Morsetto 17
Jaw 17
Spannbacke 17
Étau 17
Mordaza 17*

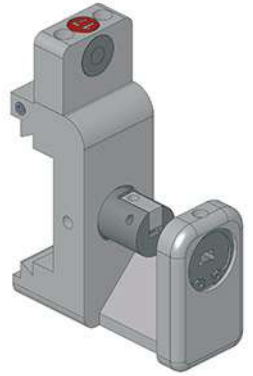

TO
FIT: **ABLOY (S)**

Novel

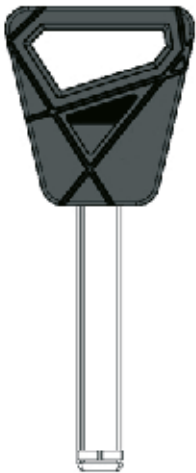

SIGMA PRO

OPTIONAL



RIC06716B
*Fresa WSPL
Cutter WSPL
Fräser WSPL
Fraise WSPL
Fresa WSPL*

OPZ10433B
*Morsetto 18
Jaw 18
Spannbacke 18
Étau 18
Mordaza 18*

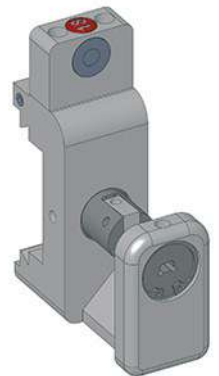

OPTIONAL

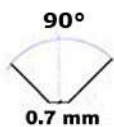

RIC01791B
Fresino HB001
Cutter HB001
Fräser HB001
Fraise HB001
Fresa HB001



RIC01792B
Tastatore B001
Tracer Point B001
Taster B001
Palpeur B001
Palpador B001

STANDARD



RIC01793B
Fresino HB020
Cutter HB020
Fräser HB020
Fraise HB020
Fresa HB020



RIC01794B
Tastatore B020
Tracer Point B020
Taster B020
Palpeur B020
Palpador B020



303/304/305



**T-REX
T-REX ADVANCE**



PUNTO

Extra Classe



CA48

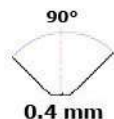

RIC05044B
Fresino V001
Cutter V001
Fräser V001
Fraise V001
Fresa V001
STANDARD



OR

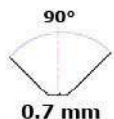

RIC05618B
Fresino V013
Cutter V013
Fräser V013
Fraise V013
Fresa V013
OPTIONAL

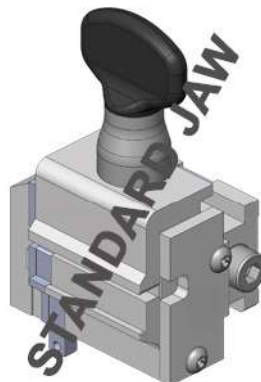

NINJA TOTAL



NINJA VORTEX



VERSA

TO FIT: **ABUS (D)**

TS/TSX

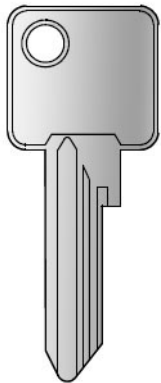

→ CISA



DEZMO

OPTIONAL

OPZ08624B
 Morsetto Z21 per chiavi SP-TSP
 Jaw Z21 for SP-TSP keys
 Spannbacke Z21 für SP-TSP Schlüssel
 Étau Z21 pour clés SP-TSP
 Mordaza Z21 para llaves SP-TSP



TO FIT: **ABUS (D)**

DX6-DX8

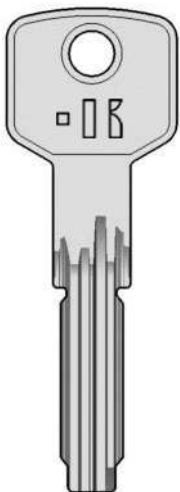

CA70

→ CISA



303/304/305



**T-REX
T-REX ADVANCE**



PUNTO

OPTIONAL

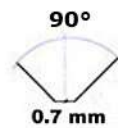

RIC01791B
 Fresino HB001
 Cutter HB001
 Fräser HB001
 Fraise HB001
 Fresa HB001



RIC01792B
 Tastatore B001
 Tracer Point B001
 Taster B001
 Palpeur B001
 Palpador B001

STANDARD

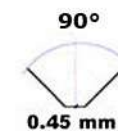

RIC01793B
 Fresino HB020
 Cutter HB020
 Fräser HB020
 Fraise HB020
 Fresa HB020



RIC01794B
 Tastatore B020
 Tracer Point B020
 Taster B020
 Palpeur B020
 Palpador B020

TO
FIT :

ABUS (D)

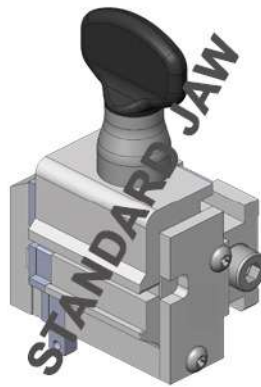
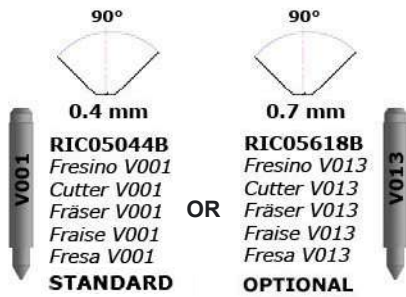

NINJA TOTAL



NINJA VORTEX



VERSA

DX6-DX8

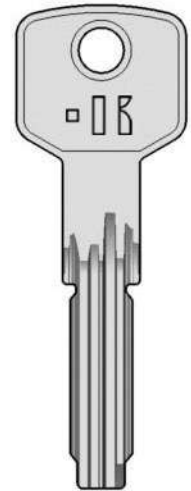

CA70



→ CISA

TO
FIT :

ABUS (D)

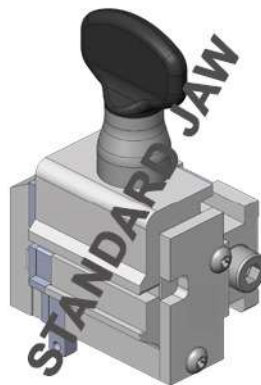
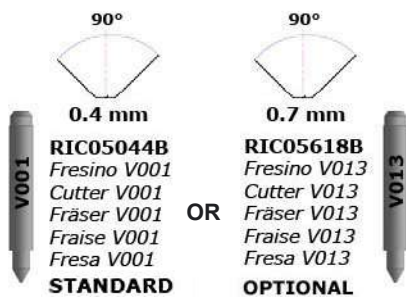

NINJA TOTAL



NINJA VORTEX



VERSA

XP2

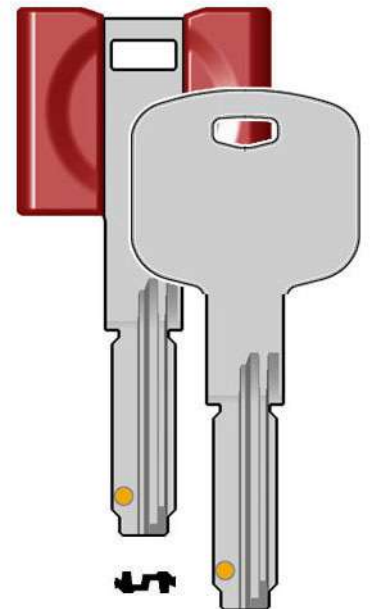

→ CISA



PROTECTED
SYSTEM

TO
FIT: **ABUS (D)**

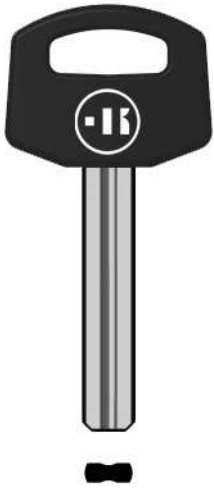

ABU12P

PLUS



**POWER LYNX
SIGMA PRO**

OPTIONAL

OPZ05313B

*Morsetto 08 per chiavi Abus Plus
Jaw 08 for Abus Plus keys
Spannbacke 08 für Abus Plus-Schlüssel
Étau 08 pour clés Abus Plus
Mordaza 08 para llaves Abus Plus*

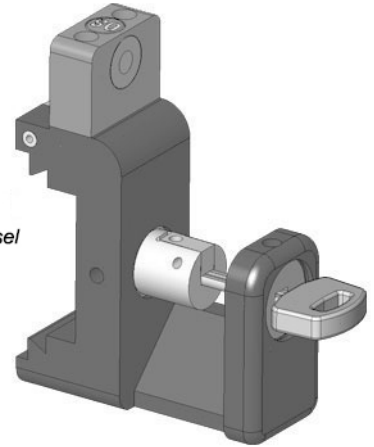

FALCON

OPTIONAL

OPZ08763B

*Morsetto 02 per chiavi Abus
Jaw 02 for Abus keys
Spannbacke 02 für Abus Schlüssel
Étau 02 pour clés Abus
Mordaza 02 para llaves Abus*



TO
FIT: **ABUS (D)**



GRANIT



**POWER LYNX
SIGMA PRO**

OPTIONAL

OPZ05315B

*Morsetto 07 per chiavi Abus Granit
Jaw 07 for Abus Granit keys
Spannbacke 07 für Abus Granit-Schlüssel
Étau 07 pour clés Abus Granit
Mordaza 07 para llaves Abus Granit*

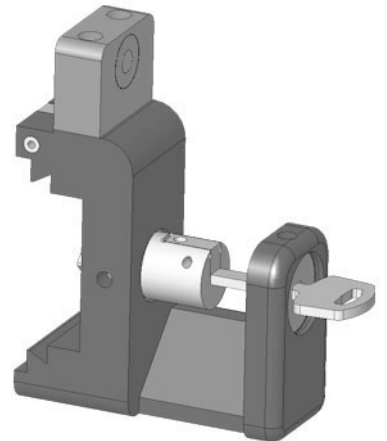

OPTIONAL

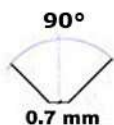

RIC01791B
Fresino HB001
Cutter HB001
Fräser HB001
Fraise HB001
Fresa HB001



RIC01792B
Tastatore B001
Tracer Point B001
Taster B001
Palpeur B001
Palpador B001

STANDARD

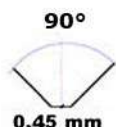

RIC01793B
Fresino HB020
Cutter HB020
Fräser HB020
Fraise HB020
Fresa HB020



RIC01794B
Tastatore B020
Tracer Point B020
Taster B020
Palpeur B020
Palpador B020



303/304/305



**T-REX
T-REX ADVANCE**



PUNTO

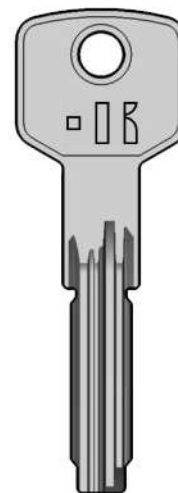

ABU48

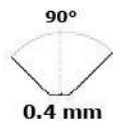

RIC05044B
Fresino V001
Cutter V001
Fräser V001
Fraise V001
Fresa V001
STANDARD



OR

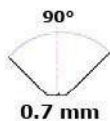

RIC05618B
Fresino V013
Cutter V013
Fräser V013
Fraise V013
Fresa V013
OPTIONAL

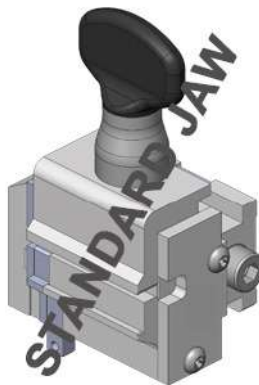

NINJA TOTAL



NINJA VORTEX



VERSA

BRAVUS

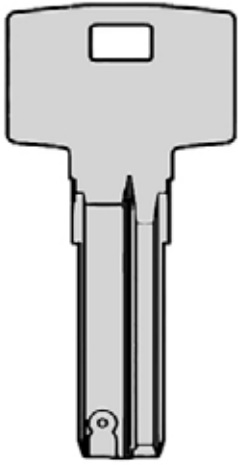

NINJA TOTAL



NINJA VORTEX



VERSA

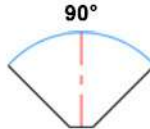

0.2 mm



RIC09442B
 Fresino V044
 Cutter V044
 Fräser V044
 Fraise V044
 Fresa V044
OPTIONAL

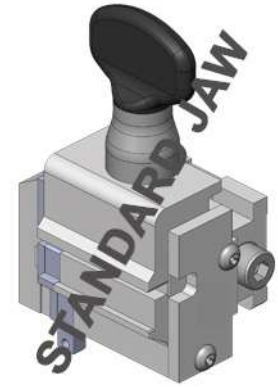

VITESS



DEZMO

OPTIONAL

OPZ08431B
 Morsetto Z19 per chiavi Pfaffenhain
 Jaw Z19 for Pfaffenhain keys
 Spannbacke Z19 für Pfaffenhain Schlüssel
 Étau Z19 pour clés Pfaffenhain
 Mordaza Z19 para llaves Pfaffenhain

FOR EDGE CUT



NINJA TOTAL



NINJA NINJA DARK

OPTIONAL

OPZ09531B
 Morsetto N25
 Jaw N25
 Spannbacke N25
 Étau N25
 Mordaza N25

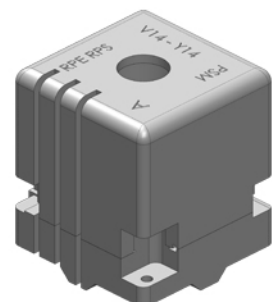

TO
FIT :

ABUS (D)

OPTIONAL

OPZ08343B
Morsetto 13
Jaw 13
Spannbacke 13
Étau 13
Mordaza 13

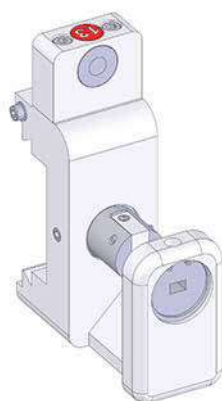

SIGMA PRO

X-Plus

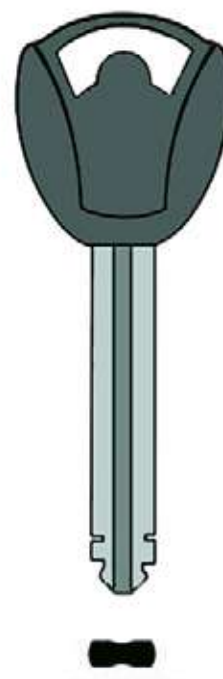

TO
FIT :

ABUS (D)

OPTIONAL

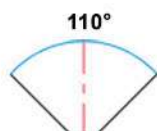

110°

0.3 mm



RIC05270B
Fresino V010
Cutter V010
Fräser V010
Fraise V010
Fresa V010

OPZ06039B
Morsetto C08
Jaw C08
Spannbacke C08
Étau C08
Mordaza C08



NINJA VORTEX



VERSA

Zolit



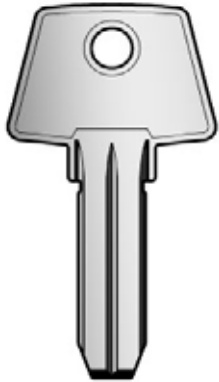

7/9



303/304/305



**T-REX
T-REX ADVANCE**



PUNTO



NINJA TOTAL



NINJA VORTEX



VERSA

OPTIONAL

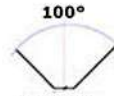

0.7 mm

RIC01789B
Fresino HB042
Cutter HB042
Fräser HB042
Fraise HB042
Fresa HB042



RIC01790B
Tastatore B042
Tracer Point B042
Taster B042
Palpeur B042
Palpador B042

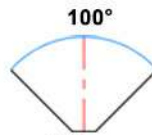

0.4 mm

RIC05264B
Fresino V007
Cutter V007
Fräser V007
Fraise V007
Fresa V007
OPTIONAL

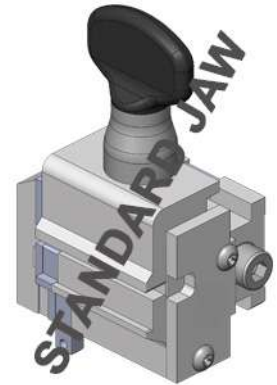

STANDARD

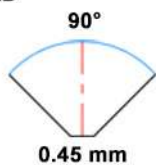

0.45 mm

RIC01793B
Fresino HB020
Cutter HB020
Fräser HB020
Fraise HB020
Fresa HB020



RIC01794B
Tastatore B020
Tracer Point B020
Taster B020
Palpeur B020
Palpador B020

OPTIONAL

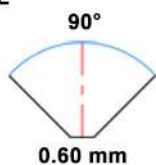

0.60 mm

RIC01785B
Fresino HB039
Cutter HB039
Fräser HB039
Fraise HB039
Fresa HB039



RIC01786B
Tastatore B039
Tracer Point B039
Taster B039
Palpeur B039
Palpador B039



303/304/305



**T-REX
T-REX ADVANCE**



PUNTO

SCUDO 5000

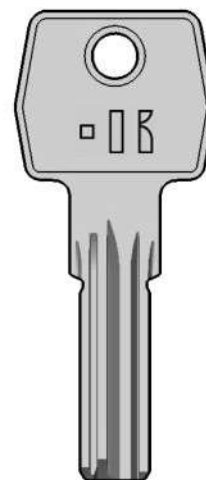

**HNH
AGB6**

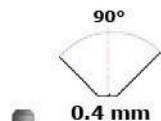

0.4 mm

RIC05044B
Fresino V001
Cutter V001
Fräser V001
Fraise V001
Fresa V001
STANDARD

OR

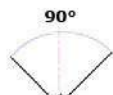

0.6 mm

RIC05612B
Fresino V014
Cutter V014
Fräser V014
Fraise V014
Fresa V014
OPTIONAL

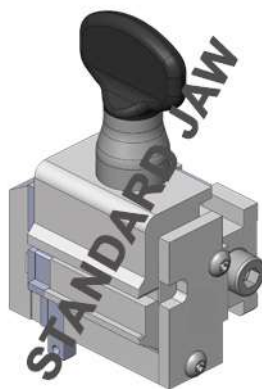

NINJA TOTAL



NINJA VORTEX



VERSA

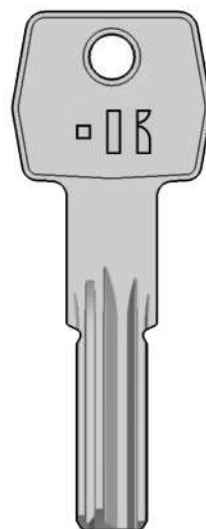

**HNH
AGB8**

SCUDO 9000

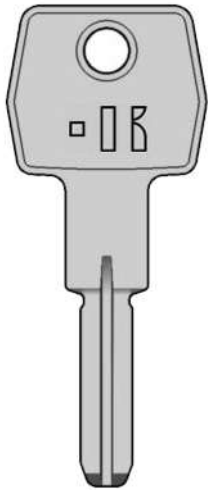

AGB1



303/304/305

**T-REX
T-REX ADVANCE**

PUNTO



NINJA TOTAL



NINJA VORTEX



VERSA

OPTIONAL

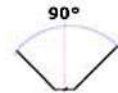

0.6 mm

RIC01785B
Fresino HB039
Cutter HB039
Fräser HB039
Fraise HB039
Fresa HB039



RIC01786B
Tastatore B039
Tracer Point B039
Taster B039
Palpeur B039
Palpador B039

STANDARD

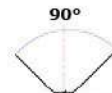

0.4 mm

RIC05044B
Fresino V001
Cutter V001
Fräser V001
Fraise V001
Fresa V001

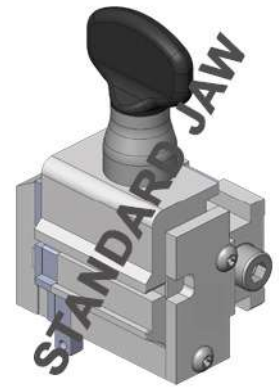

TO
FIT :

ASSA (S)

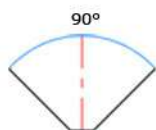

0.40 mm



RIC05044B
Fresino V001
Cutter V001
Fräser V001
Fraise V001
Fresa V001
STANDARD

OR

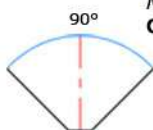

0.70 mm



RIC05618B
Fresino V013
Cutter V013
Fräser V013
Fraise V013
Fresa V013
OPTIONAL

OPZ06039B
Morsetto C08
Jaw C08
Spannbacke C08
Étau C08
Mordaza C08
OPTIONAL



NINJA VORTEX



VERSA

Flexcore
Guideline
Twin
Serie 600



TO
FIT :

ASSA (S)

OPTIONAL

OPZ08363B
Morsetto Z16 per chiavi ASSA d-12
Jaw Z16 for ASSA d-12 keys
Spannbacke Z16 für ASSA d-12 Schlüssel
Étau Z16 pour clés ASSA d-12
Mordaza Z16 para llaves ASSA d-12

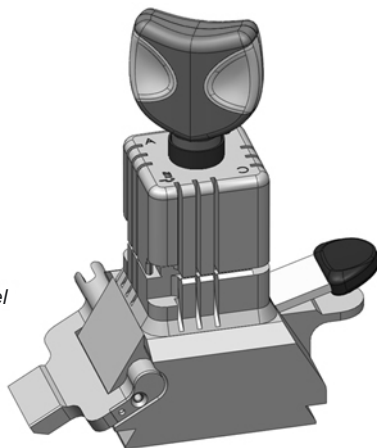

DEZMO

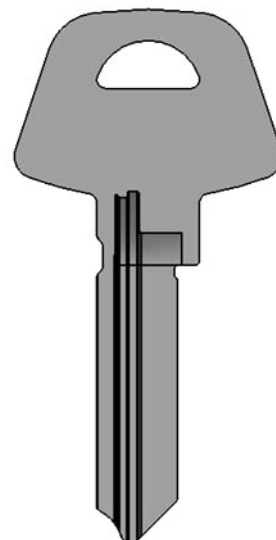

OPTIONAL

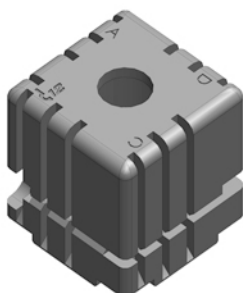

OPZ08362B
Morsetto 4 facce per Assa d-12
Jaw 4 sides for Assa d-12 keys
Spannbacke 4 seiten für Assa d-12 Schlüssel
Étau 4 faces pour clés Assa d-12
Mordaza 4 lados para llaves Assa d-12



CARAT/106



d-12

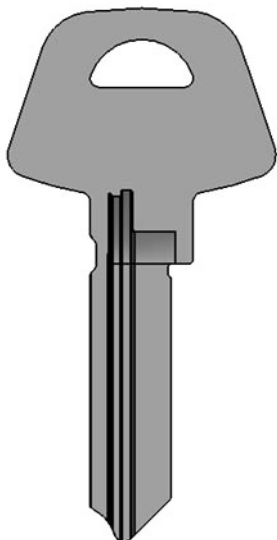

DROMO

OPTIONAL

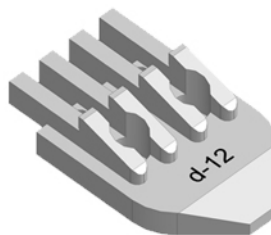

OPZ08526B
Adattatore Dromo per Assa d-12
Dromo Adaptor for Assa d-12 keys
Dromo Adapter für Assa d-12 Schlüssel
Adaptateur Dromo pour clés Assa d-12
Adaptador Dromo para llaves Assa d-12

Per i Dromo con matricola inferiore a 17810009999, contattare Keyline.
For Dromos with SN before 17810009999, please contact Keyline.
Für Dromo mit Seriennummer unter Nummer 17810009999, setzen Sie sich mit Keyline in Verbindung.
Pour le Dromo avec matricule inférieure à 17810009999, nous vous prions de contacter Keyline.
Para los Dromo con matricula inferior a 17810009999, contactar Keyline.



NINJA VORTEX



VERSA

OPTIONAL

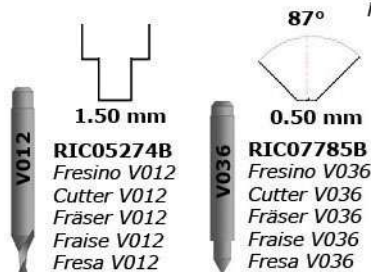

V012
RIC05274B
Fresino V012
Cutter V012
Fräser V012
Fraise V012
Fresa V012

V036
RIC07785B
Fresino V036
Cutter V036
Fräser V036
Fraise V036
Fresa V036

OPZ08254B
Morsetto C18
Jaw C18
Spannbacke C18
Étau C18
Mordaza C18

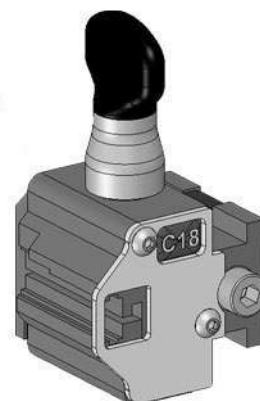

NINJA LASER



NINJA TOTAL



**NINJA
NINJA DARK**

OPTIONAL

OPZ09125B
Morsetto N16 per chiavi ASSA d-12
Jaw N16 for ASSA d-12 keys
Spannbacke N16 für ASSA d-12 Schlüssel
Étau N16 pour clés ASSA d-12
Mordaza N16 para llaves ASSA d-12

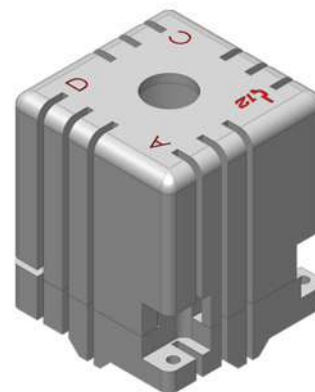

TO
FIT :

ASSA (S)

OPZ06039B
Morsetto C08
Jaw C08
Spannbacke C08
Étau C08
Mordaza C08
OPTIONAL



NINJA VORTEX



VERSA

ASSA DP

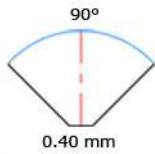
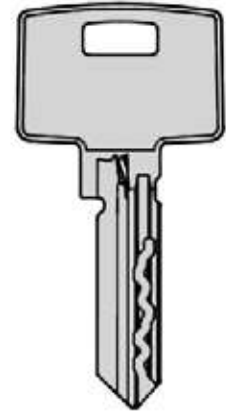

0.40 mm



RIC05044B
Fresino V001
Cutter V001
Fräser V001
Fraise V001
Fresa V001
STANDARD

OR

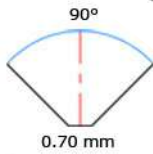

0.70 mm



RIC05618B
Fresino V013
Cutter V013
Fräser V013
Fraise V013
Fresa V013
OPTIONAL

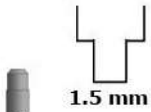

1.5 mm



RIC05274B
Fresino V012
Cutter V012
Fräser V012
Fraise V012
Fresa V012
OPTIONAL

TO
FIT :

ASSA (S)

OPTIONAL

OPZ06039B
Morsetto C08
Jaw C08
Spannbacke C08
Étau C08
Mordaza C08

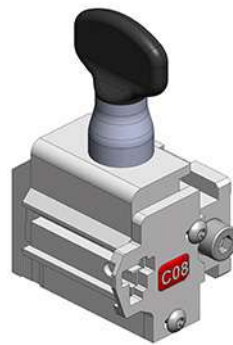

NINJA VORTEX



VERSA

Serie 500
Serie 700

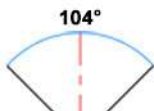
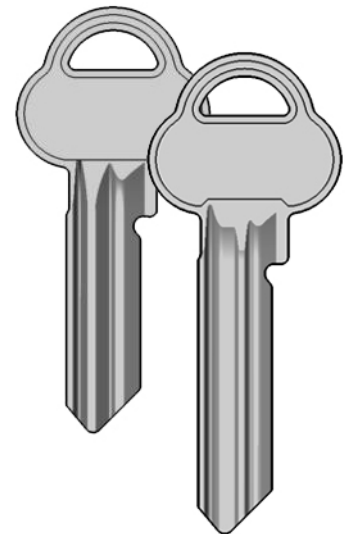

0.40 mm



RIC06370B
Fresino V025
Cutter V025
Fräser V025
Fraise V025
Fresa V025

TO FIT: ASSA (S)

Guideline



NINJA TOTAL



NINJA VORTEX



VERSA

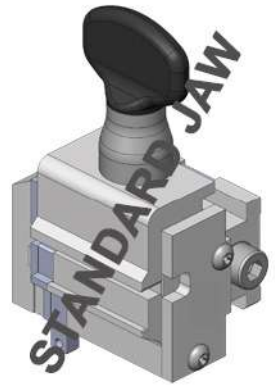
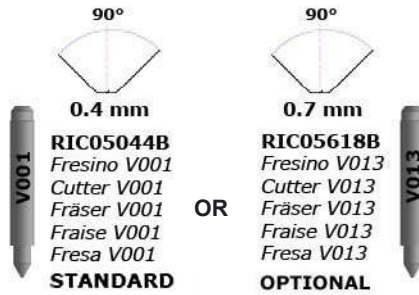

TO FIT: ASSA (S)

K100



NINJA TOTAL



NINJA VORTEX



VERSA

OPTIONAL



OPZ10427B
Morsetto C39
Jaw C39
Spannbacke C39
Étau C39
Mordaza C39



TO
FIT :

ATRA (I)

OPTIONAL

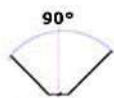

0.6 mm

RIC01785B

*Fresino HB039
Cutter HB039
Fräser HB039
Fraise HB039
Fresa HB039*



RIC01786B

*Tastatore B039
Tracer Point B039
Taster B039
Palpeur B039
Palpador B039*



303/304/305



**T-REX
T-REX ADVANCE**



PUNTO

Power

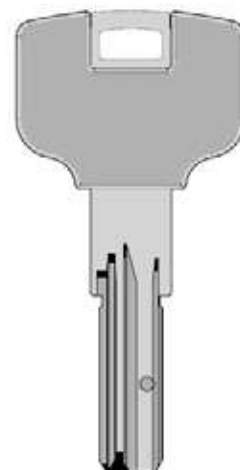

HNH



TO
FIT :

ATRA (I)

STANDARD

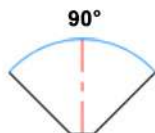

0.45 mm

RIC01793B

*Fresino HB020
Cutter HB020
Fräser HB020
Fraise HB020
Fresa HB020*



RIC01794B

*Tastatore B020
Tracer Point B020
Taster B020
Palpeur B020
Palpador B020*



303/304/305



**T-REX
T-REX ADVANCE**



PUNTO

**NEOS
BOSS**

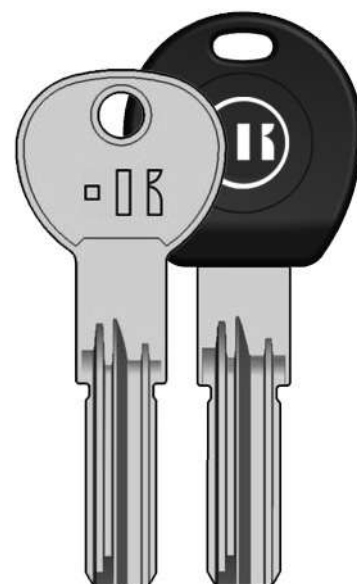

HNH

ISE14

ISE15

ISE17

HNH

ISE14P

ISE15P

ISE17P

OPTIONAL

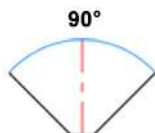

0.60 mm

RIC01785B

*Fresino HB039
Cutter HB039
Fräser HB039
Fraise HB039
Fresa HB039*



RIC01786B

*Tastatore B039
Tracer Point B039
Taster B039
Palpeur B039
Palpador B039*

TO FIT: ATRA (I)

NEOS
BOSS

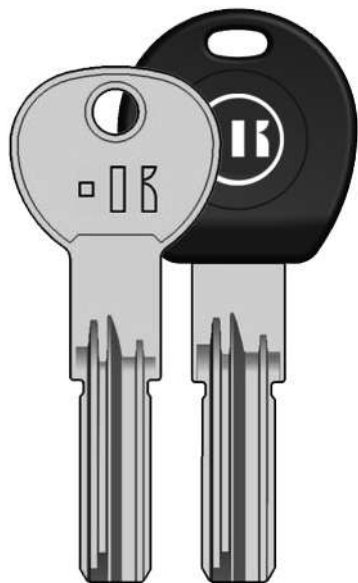

HNH **HNH**
ISE14 ISE14P
ISE15 ISE15P
ISE17 ISE17P



NINJA TOTAL



NINJA VORTEX



VERSA

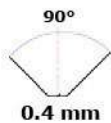

0.4 mm



RIC05044B
Fresino V001
Cutter V001
Fräser V001
Fraise V001
Fresa V001
STANDARD

OR

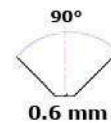

0.6 mm

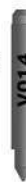

RIC05612B
Fresino V014
Cutter V014
Fräser V014
Fraise V014
Fresa V014
OPTIONAL

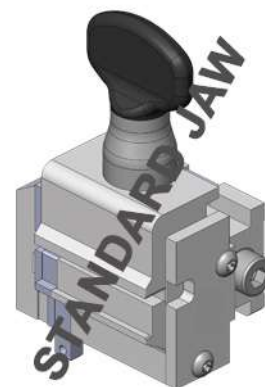

TO FIT: ATRA (I)

NEW POWER

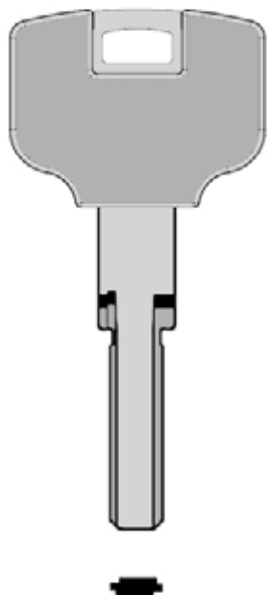

303/304/305



**T-REX
T-REX ADVANCE**



PUNTO

STANDARD

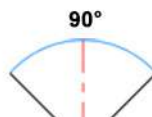

0.45 mm



RIC01793B
Fresino HB020
Cutter HB020
Fräser HB020
Fraise HB020
Fresa HB020



RIC01794B
Tastatore B020
Tracer Point B020
Taster B020
Palpeur B020
Palpador B020

OPTIONAL



2,0 mm



RIC01816B
Fresino HC044
Cutter HC044
Fräser HC044
Fraise HC044
Fresa HC044



RIC01817B
Tastatore C044
Tracer Point C044
Taster C044
Palpeur C044
Palpador C044

OPTIONAL



2 mm

RIC01816B
Fresino HC044
Cutter HC044
Fräser HC044
Fraise HC044
Fresa HC044



RIC01817B
Tastatore C044
Tracer Point C044
Taster C044
Palpeur C044
Palpador C044



303/304/305



**T-REX
T-REX ADVANCE**



PUNTO

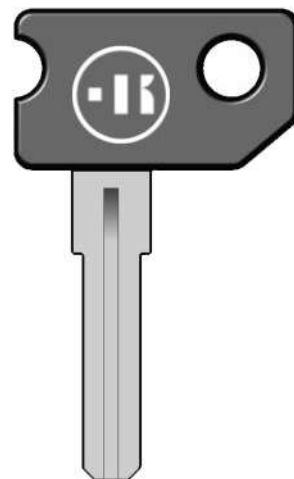

AXA1P

OPTIONAL



2.3 mm



RIC05506B
Fresino V016
Cutter V016
Fräser V016
Fraise V016
Fresa V016



OPZ06511B
Adattatore AV06 per chiavi Axa
Adaptor AV06 for Axa keys
Adapter AV06 für Axa-Schlüssel
Adaptateur AV06 pour clés Axa
Adaptador AV06 para llaves Axa

OPZ04875B
Morsetto A03
Jaw A03
Spannbacke A03
Étau A03
Mordaza A03

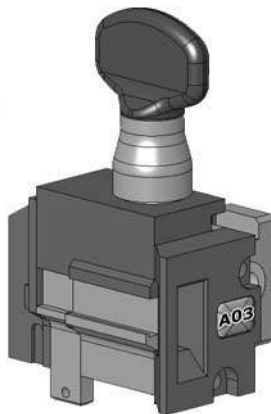

NINJA TOTAL



NINJA VORTEX



VERSA

TO FIT: **AZBE (E)**

HS3/4

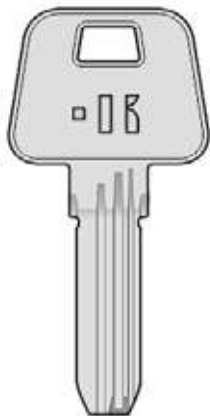

LHT
AZ6



NINJA TOTAL



NINJA VORTEX



VERSA

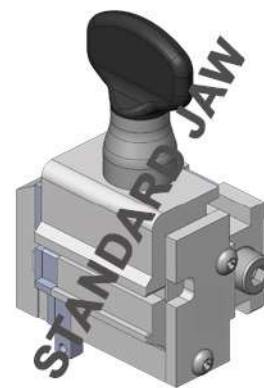
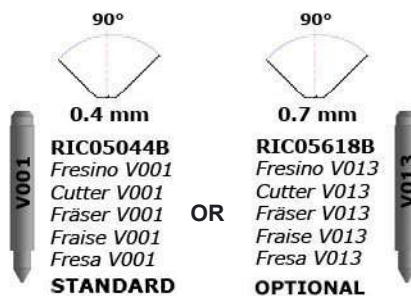

TO FIT: **AZBE (E)**

HS3/HS4
HS6/HS7

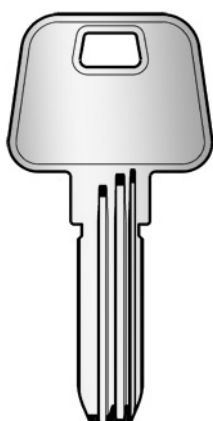

LHT



303/304/305



**T-REX
T-REX ADVANCE**



PUNTO

STANDARD

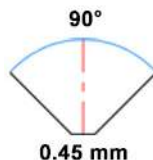

RIC01793B
Fresino HB020
Cutter HB020
Fräser HB020
Fraise HB020
Fresa HB020



RIC01794B
Tastatore B020
Tracer Point B020
Taster B020
Palpeur B020
Palpador B020

OPTIONAL

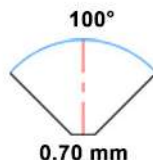

RIC01789B
Fresino HB042
Cutter HB042
Fräser HB042
Fraise HB042
Fresa HB042



RIC01790B
Tastatore B042
Tracer Point B042
Taster B042
Palpeur B042
Palpador B042

TO
FIT :

AZBE (E)

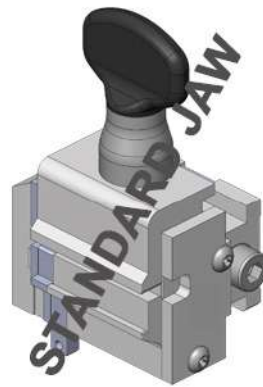
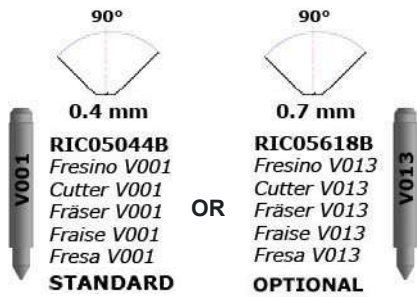

NINJA TOTAL



NINJA VORTEX



VERSA

HS3/HS4
HS6/HS7

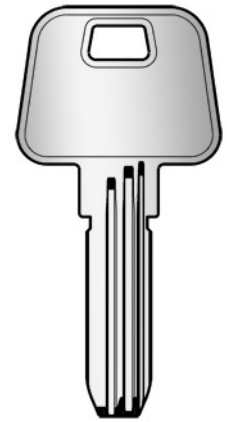

LIT

TO
FIT :

BASI (D)

STANDARD

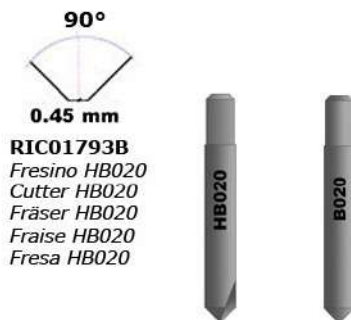

RIC01794B
Tastatore B020
Tracer Point B020
Taster B020
Palpeur B020
Palpador B020



303/304/305



**T-REX
T-REX ADVANCE**



PUNTO

CX6

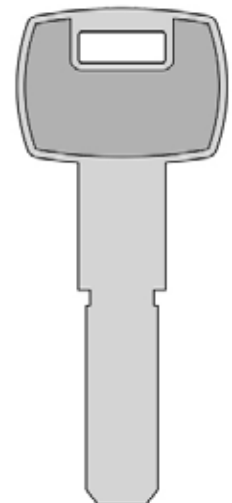

TO FIT: **BASI (D)**

CX6

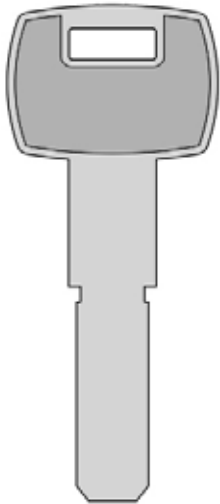

NINJA TOTAL



NINJA VORTEX



VERSA

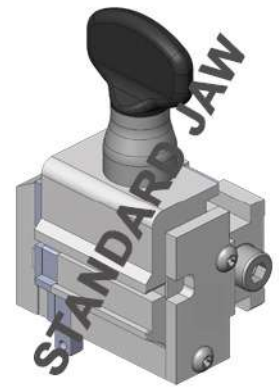
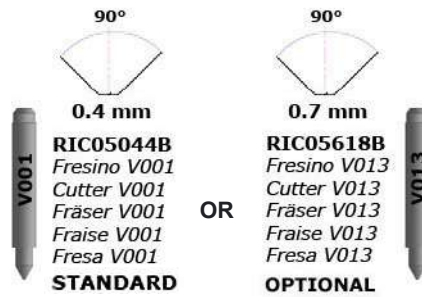

TO FIT: **BASI (D)**



BA1



NINJA VORTEX



VERSA

OPTIONAL



OPZ06039B
Morsetto C08
Jaw C08
Spannbacke C08
Étau C08
Mordaza C08



TO
FIT :

BKS (D)

OPTIONAL



3 mm

RIC05750B
Fresino V017
Cutter V017
Fräser V017
Fraise V017
Fresa V017



OPZ05765B
Morsetto C05
Jaw C05
Spannbacke C05
Étau C05
Mordaza C05

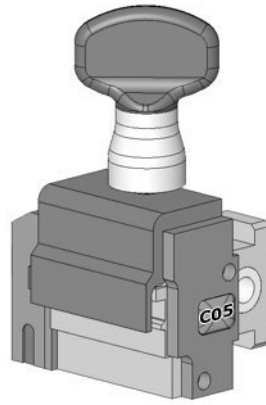

NINJA TOTAL



NINJA VORTEX



VERSA

WS50

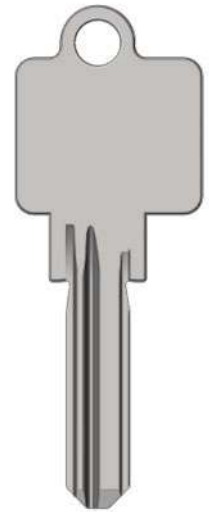

TO
FIT :

BKS (D)

OPTIONAL



3 mm

RIC05750B
Fresino V017
Cutter V017
Fräser V017
Fraise V017
Fresa V017



OPZ05767B
Morsetto C06
Jaw C06
Spannbacke C06
Étau C06
Mordaza C06

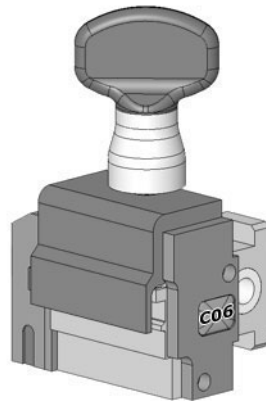

NINJA TOTAL



NINJA VORTEX



VERSA

WS50 MK

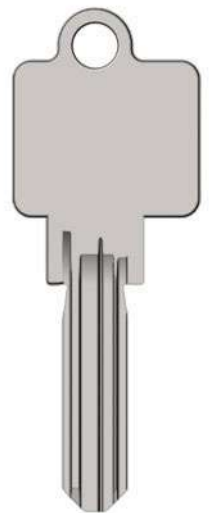

TO FIT: **BRICARD (F)**



JIT
BD16
BD13
BD21



OPTIONAL

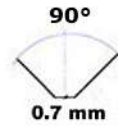

RIC01791B
*Fresino HB001
Cutter HB001
Fräser HB001
Fraise HB001
Fresa HB001*



RIC01792B
*Tastatore B001
Tracer Point B001
Taster B001
Palpeur B001
Palpador B001*

STANDARD

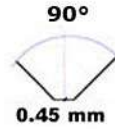

RIC01793B
*Fresino HB020
Cutter HB020
Fräser HB020
Fraise HB020
Fresa HB020*



RIC01794B
*Tastatore B020
Tracer Point B020
Taster B020
Palpeur B020
Palpador B020*

TO FIT: **BRICARD (F)**

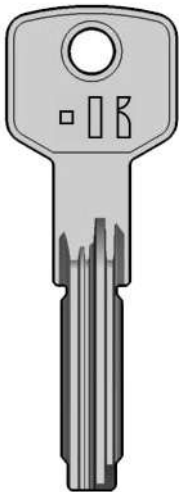

JIT
BD20



STANDARD

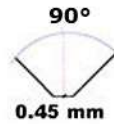

RIC01793B
*Fresino HB020
Cutter HB020
Fräser HB020
Fraise HB020
Fresa HB020*



RIC01794B
*Tastatore B020
Tracer Point B020
Taster B020
Palpeur B020
Palpador B020*

TO
FIT :

BRICARD (F)

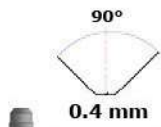

0.4 mm

RIC05044B
Fresino V001
Cutter V001
Fräser V001
Fraise V001
Fresa V001
STANDARD

OR

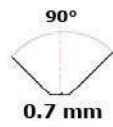

0.7 mm

RIC05618B
Fresino V013
Cutter V013
Fräser V013
Fraise V013
Fresa V013
OPTIONAL

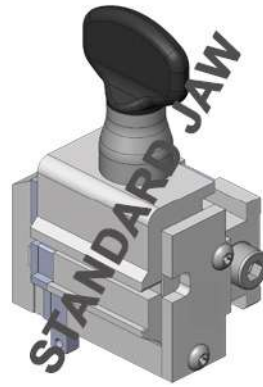

NINJA TOTAL



NINJA VORTEX



VERSA

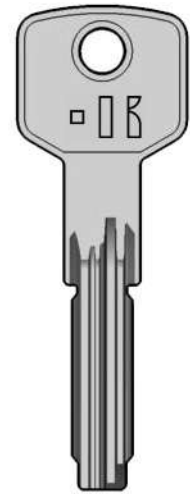

BD20

TO
FIT :

BRIDGESTONE (J)

OPTIONAL

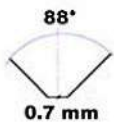

0.7 mm

RIC01792B
Tastatore B001
Tracer Point B001
Taster B001
Palpeur B001
Palpador B001



RIC08487B
Fresino WB001
Cutter WB001
Fräser WB001
Fraise WB001
Fresa WB001



304/305



**T-REX
T-REX ADVANCE**



PUNTO



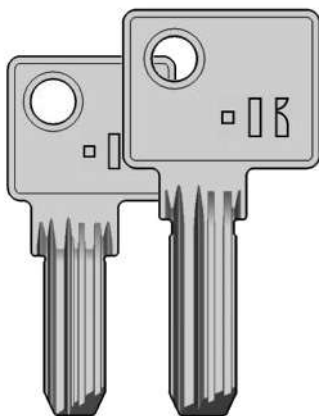

BU12 **BU13**



303/304/305

**T-REX
T-REX ADVANCE**

PUNTO

OPTIONAL

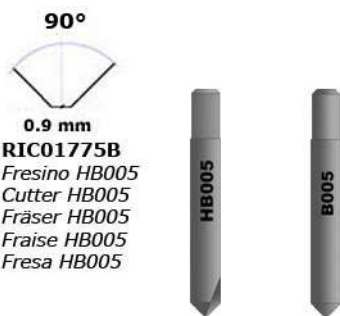

90°
0.9 mm
RIC01775B
*Fresino HB005
Cutter HB005
Fräser HB005
Fraise HB005
Fresa HB005*

RIC01776B
*Tastatore B005
Tracer Point B005
Taster B005
Palpeur B005
Palpador B005*

STANDARD

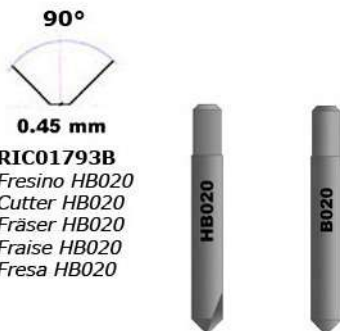

90°
0.45 mm
RIC01793B
*Fresino HB020
Cutter HB020
Fräser HB020
Fraise HB020
Fresa HB020*

RIC01794B
*Tastatore B020
Tracer Point B020
Taster B020
Palpeur B020
Palpador B020*



NINJA TOTAL

NINJA VORTEX

VERSA

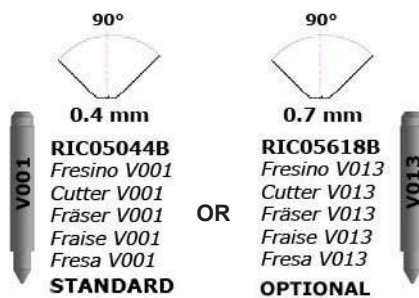

90°
0.4 mm
RIC05044B
*Fresino V001
Cutter V001
Fräser V001
Fraise V001
Fresa V001*
STANDARD

OR

90°
0.7 mm
RIC05618B
*Fresino V013
Cutter V013
Fräser V013
Fraise V013
Fresa V013*
OPTIONAL

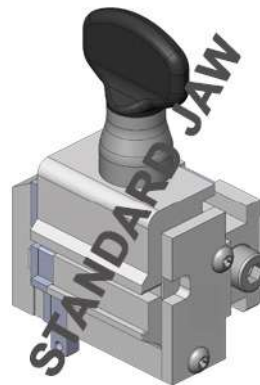

OPTIONAL

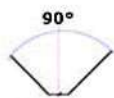

0.6 mm
RIC01785B
Fresino HB039
Cutter HB039
Fräser HB039
Fraise HB039
Fresa HB039



RIC01786B
Tastatore B039
Tracer Point B039
Taster B039
Palpeur B039
Palpador B039



303/304/305



T-REX
T-REX ADVANCE



PUNTO

WS

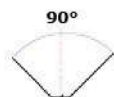

0.4 mm
RIC05044B
Fresino V001
Cutter V001
Fräser V001
Fraise V001
Fresa V001
STANDARD



OR

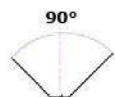

0.6 mm
RIC05612B
Fresino V014
Cutter V014
Fräser V014
Fraise V014
Fresa V014
OPTIONAL

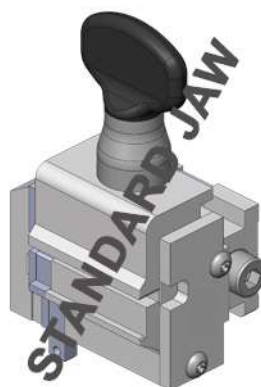

NINJA TOTAL



NINJA VORTEX



VERSA

PSM
UDM

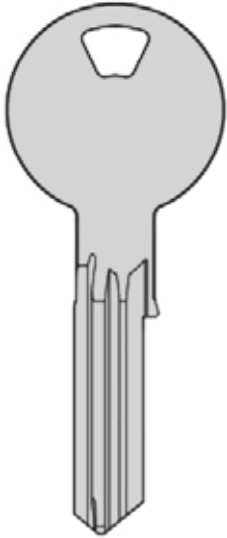

NINJA LASER



NINJA TOTAL



**NINJA
NINJA DARK**

OPTIONAL

OPZ09531B
Morsetto N25
Jaw N25
Spannbacke N25
Étau N25
Mordaza N25

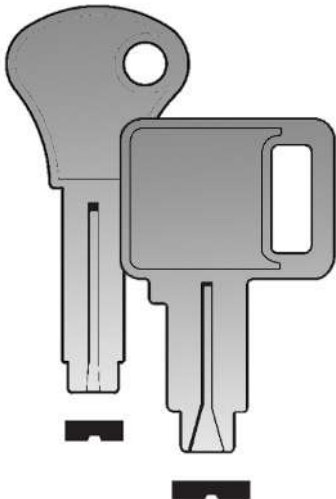
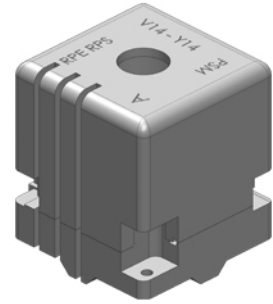

206

OPTIONAL

OPZ06365B
Morsetti per chiavi CHUBB
Jaws for CHUBB keys
Spannbacken für CHUBB
Étaux pour clés CHUBB
Mordazas para CHUBB

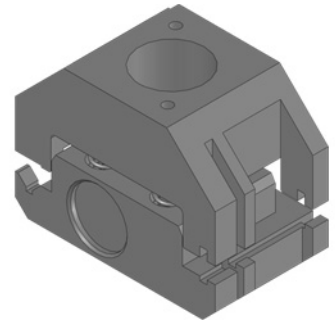

TO
FIT :

CHUBB (GB)

OPTIONAL

OPZ08389B
Morsetto 14
Jaw 14
Spannbacke 14
Étau 14
Mordaza 14

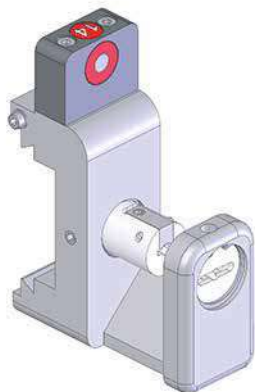

SIGMA PRO

Ava



TO
FIT :

CISA (I)

OPTIONAL

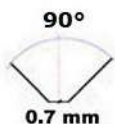

0.7 mm

RIC01791B
Fresino HB001
Cutter HB001
Fräser HB001
Fraise HB001
Fresa HB001



RIC01792B
Tastatore B001
Tracer Point B001
Taster B001
Palpeur B001
Palpador B001

STANDARD

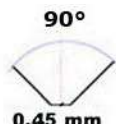

0.45 mm

RIC01793B
Fresino HB020
Cutter HB020
Fräser HB020
Fraise HB020
Fresa HB020



RIC01794B
Tastatore B020
Tracer Point B020
Taster B020
Palpeur B020
Palpador B020



303/304/305



PUNTO

Astral Tekno

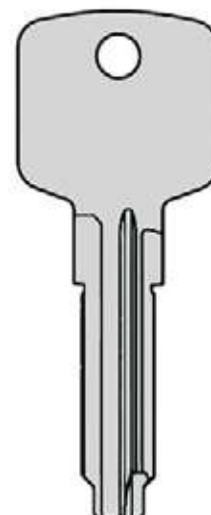

OPZ10656B

Adattatore AD07 per chiavi Cisa Astral Tekno
Adaptor AD07 for Cisa Astral Tekno keys
Adapter AD07 für Cisa Astral Tekno-Schlüssel
Adaptateur AD07 pour clés Cisa Astral Tekno
Adaptador AD07 para llaves Cisa Astral Tekno

OPTIONAL



Astral Tekno

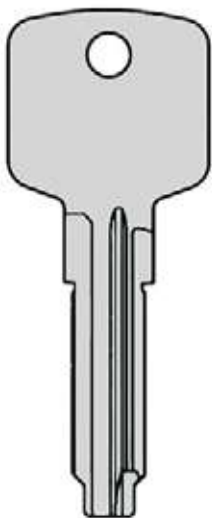

**T-REX
T-REX ADVANCE**

OPTIONAL

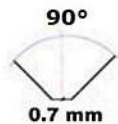

RIC01791B
Fresino HB001
Cutter HB001
Fräser HB001
Fraise HB001
Fresa HB001



RIC01792B
Tastatore B001
Tracer Point B001
Taster B001
Palpeur B001
Palpador B001

STANDARD

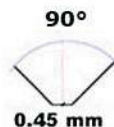

RIC01793B
Fresino HB020
Cutter HB020
Fräser HB020
Fraise HB020
Fresa HB020



RIC01794B
Tastatore B020
Tracer Point B020
Taster B020
Palpeur B020
Palpador B020



NINJA TOTAL



NINJA VORTEX



VERSA

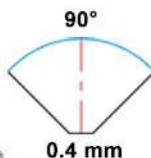

RIC05044B
Fresino V001
Cutter V001
Fräser V001
Fraise V001
Fresa V001
STANDARD

OR

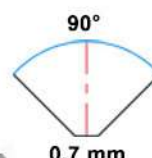

RIC05618B
Fresino V013
Cutter V013
Fräser V013
Fraise V013
Fresa V013
OPTIONAL

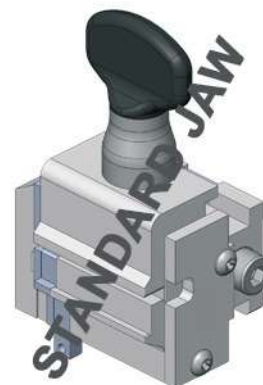

OPZ10271B
Adattatore AV09 per chiavi Cisa
Adaptor AV09 for Cisa keys
Adapter AV09 für Cisa-Schlüssel
Adaptateur AV09 pour clés Cisa
Adaptador AV09 para llaves Cisa
OPTIONAL



TO
FIT :

CISA (I)

OPTIONAL

OPZ08624B

Morsetto Z21 per chiavi SP-TSP
Jaw Z21 for SP-TSP keys
Spannbacke Z21 für SP-TSP Schlüssel
Étau Z21 pour clés SP-TSP
Mordaza Z21 para llaves SP-TSP

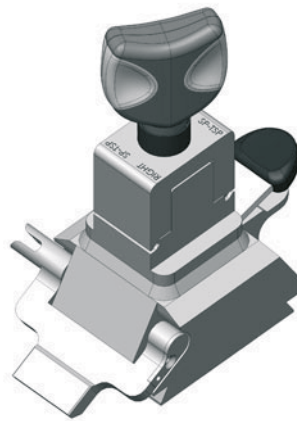

DEZMO

SP/TSP

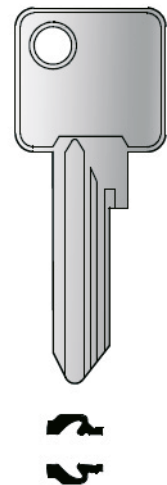

TO
FIT :

CISA (I)

OPTIONAL

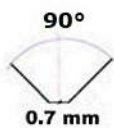

RIC01791B
Fresino HB001
Cutter HB001
Fräser HB001
Fraise HB001
Fresa HB001



RIC01792B
Tastatore B001
Tracer Point B001
Taster B001
Palpeur B001
Palpador B001

STANDARD

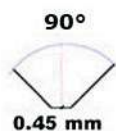

RIC01793B
Fresino HB020
Cutter HB020
Fräser HB020
Fraise HB020
Fresa HB020



RIC01794B
Tastatore B020
Tracer Point B020
Taster B020
Palpeur B020
Palpador B020



303/304/305



**T-REX
T-REX ADVANCE**



PUNTO

NEW ASTRAL

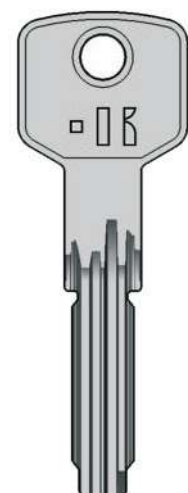

CA62

NEW ASTRAL

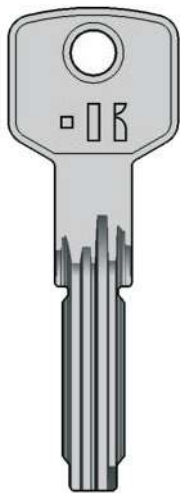

CA62



NINJA TOTAL



NINJA VORTEX



VERSA

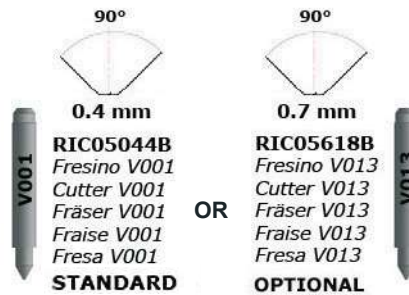

RIC05044B
Fresino V001
Cutter V001
Fräser V001
Fraise V001
Fresa V001
STANDARD

OR

RIC05618B
Fresino V013
Cutter V013
Fräser V013
Fraise V013
Fresa V013
OPTIONAL

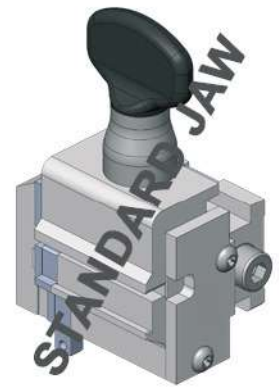

AXIS

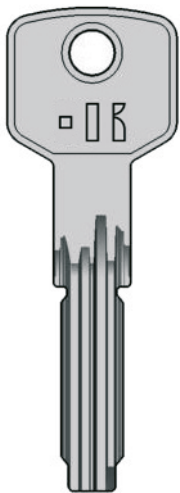

CA70



303/304/305



**T-REX
T-REX ADVANCE**



PUNTO

OPTIONAL

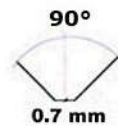

RIC01791B
Fresino HB001
Cutter HB001
Fräser HB001
Fraise HB001
Fresa HB001



RIC01792B
Tastatore B001
Tracer Point B001
Taster B001
Palpeur B001
Palpador B001

STANDARD

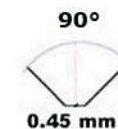

RIC01793B
Fresino HB020
Cutter HB020
Fräser HB020
Fraise HB020
Fresa HB020



RIC01794B
Tastatore B020
Tracer Point B020
Taster B020
Palpeur B020
Palpador B020

TO
FIT :

CISA (I)

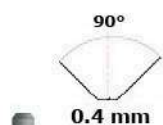

0.4 mm

RIC05044B
Fresino V001
Cutter V001
Fräser V001
Fraise V001
Fresa V001
STANDARD

OR

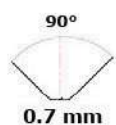

0.7 mm

RIC05618B
Fresino V013
Cutter V013
Fräser V013
Fraise V013
Fresa V013
OPTIONAL

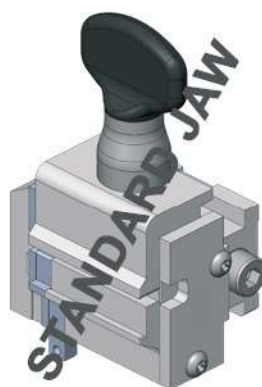

NINJA TOTAL



NINJA VORTEX



VERSA

AXIS

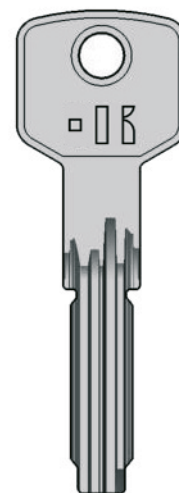

CA70

TO
FIT :

CISA (I)

OPTIONAL

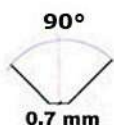

0.7 mm

RIC01791B
Fresino HB001
Cutter HB001
Fräser HB001
Fraise HB001
Fresa HB001



RIC01792B
Tastatore B001
Tracer Point B001
Taster B001
Palpeur B001
Palpador B001

STANDARD

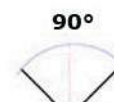

0.45 mm

RIC01793B
Fresino HB020
Cutter HB020
Fräser HB020
Fraise HB020
Fresa HB020



RIC01794B
Tastatore B020
Tracer Point B020
Taster B020
Palpeur B020
Palpador B020



303/304/305



**T-REX
T-REX ADVANCE**



PUNTO

AP3/AP4

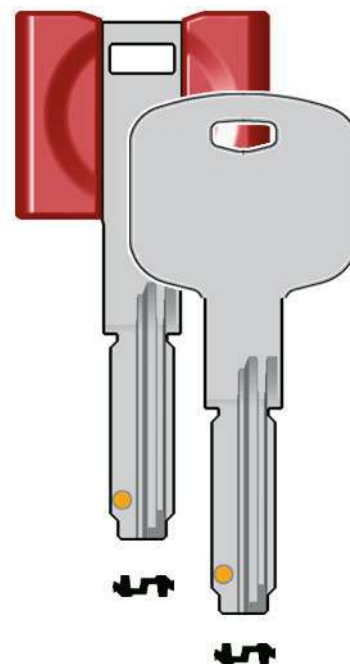

TO FIT: CISA (I)

AP3/AP4

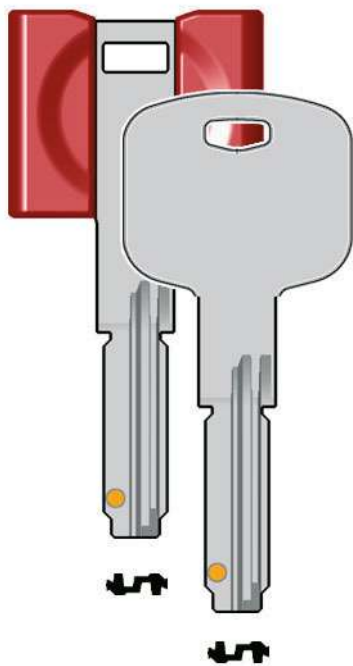

NINJA TOTAL



NINJA VORTEX



VERSA

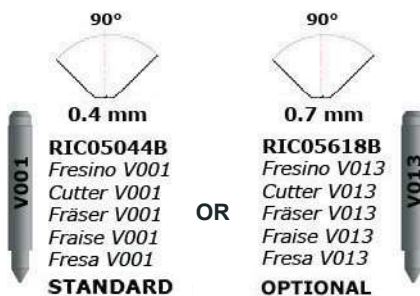

RIC05044B
Fresino V001
Cutter V001
Fräser V001
Fraise V001
Fresa V001
STANDARD

OR

RIC05618B
Fresino V013
Cutter V013
Fräser V013
Fraise V013
Fresa V013
OPTIONAL

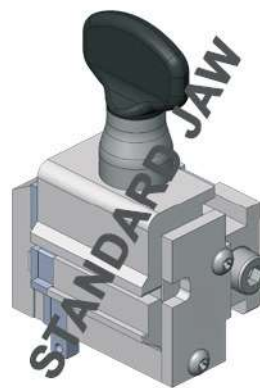

TO FIT: CISA (I)

ASTRAL

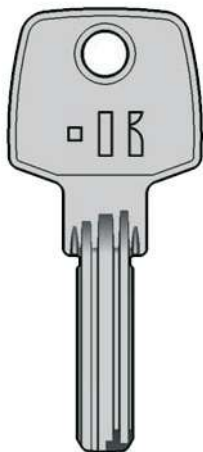

CA48



303/304/305



T-REX
T-REX ADVANCE



PUNTO

OPTIONAL

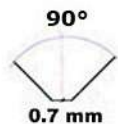

RIC01791B
Fresino HB001
Cutter HB001
Fräser HB001
Fraise HB001
Fresa HB001



RIC01792B
Tastatore B001
Tracer Point B001
Taster B001
Palpeur B001
Palpador B001

STANDARD

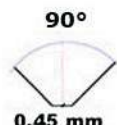

RIC01793B
Fresino HB020
Cutter HB020
Fräser HB020
Fraise HB020
Fresa HB020



RIC01794B
Tastatore B020
Tracer Point B020
Taster B020
Palpeur B020
Palpador B020

TO
FIT :

CISA (I)

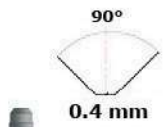

0.4 mm

RIC05044B
Fresino V001
Cutter V001
Fräser V001
Fraise V001
Fresa V001
STANDARD

OR

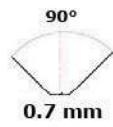

0.7 mm

RIC05618B
Fresino V013
Cutter V013
Fräser V013
Fraise V013
Fresa V013
OPTIONAL

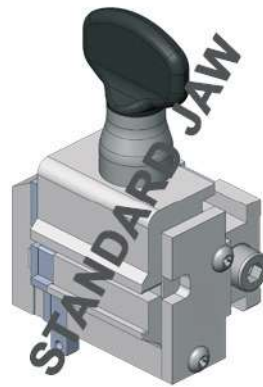

NINJA TOTAL



NINJA VORTEX



VERSA

ASTRAL

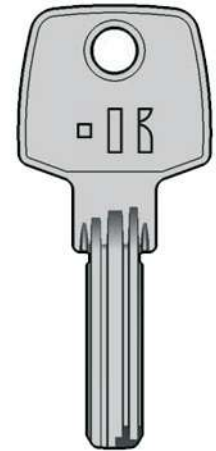

CA48

TO
FIT :

CITY (F)

OPTIONAL

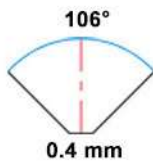

0.4 mm

RIC05266B
Fresino V008
Cutter V008
Fräser V008
Fraise V008
Fresa V008



OPZ06039B
Morsetto C08
Jaw C08
Spannbacke C08
Étau C08
Mordaza C08



NINJA VORTEX



VERSA



ISE5S

TO FIT: **CODEM (F)**



FTH12



OPTIONAL

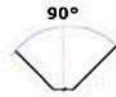

0.9 mm

RIC01775B
*Fresino HB005
 Cutter HB005
 Fräser HB005
 Fraise HB005
 Fresa HB005*



RIC01776B
*Tastatore B005
 Tracer Point B005
 Taster B005
 Palpeur B005
 Palpador B005*

TO FIT: **CORBIN (I)**

Euroval

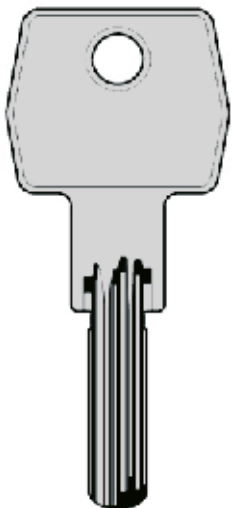

OPTIONAL

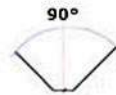

0.9 mm

RIC01775B
*Fresino HB005
 Cutter HB005
 Fräser HB005
 Fraise HB005
 Fresa HB005*



RIC01776B
*Tastatore B005
 Tracer Point B005
 Taster B005
 Palpeur B005
 Palpador B005*

TO
FIT :

CORBIN (I)

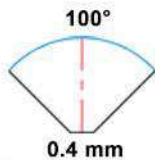

RIC05264B
Fresino V007
Cutter V007
Fräser V007
Fraise V007
Fresa V007
OPTIONAL

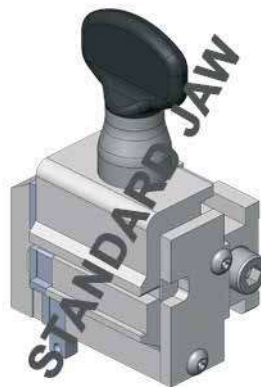

NINJA TOTAL



NINJA VORTEX



VERSA

Goldstar



ML13P

TO
FIT :

CORBIN (I)

STANDARD

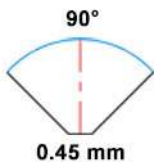

RIC01793B
Fresino HB020
Cutter HB020
Fräser HB020
Fraise HB020
Fresa HB020

RIC01794B
Tastatore B020
Tracer Point B020
Taster B020
Palpeur B020
Palpador B020



303/304/305



**T-REX
T-REX ADVANCE**



PUNTO

EUROSTAR

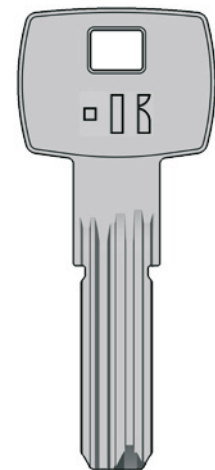

COR87

OPTIONAL

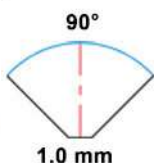

RIC01822B
Fresino HB043
Cutter HB043
Fräser HB043
Fraise HB043
Fresa HB043

RIC01823B
Tastatore B043
Tracer Point B043
Taster B043
Palpeur B043
Palpador B043

TO FIT: **CORBIN (I)**

EUROSTAR

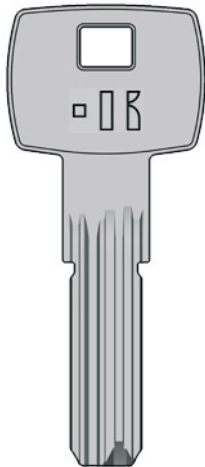

COR87



NINJA TOTAL



NINJA VORTEX



VERSA

90°  90°

0.4 mm
RIC05044B
Fresino V001
Cutter V001
Fräser V001
Fraise V001
Fresa V001
STANDARD

OR

0.7 mm
RIC05618B
Fresino V013
Cutter V013
Fräser V013
Fraise V013
Fresa V013
OPTIONAL



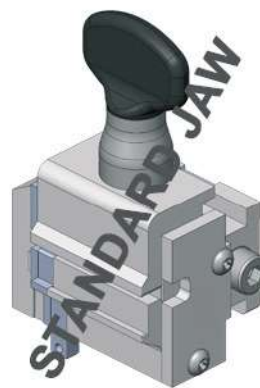

TO FIT: **CORNI (I)**

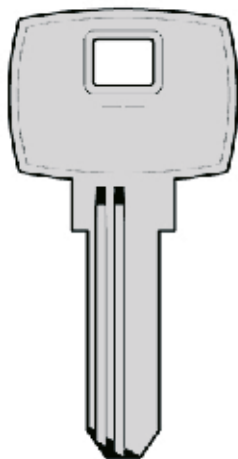

FB



303/304/305



T-REX
T-REX ADVANCE



PUNTO

OPTIONAL

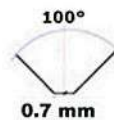

RIC01789B
Fresino HB042
Cutter HB042
Fräser HB042
Fraise HB042
Fresa HB042



RIC01790B
Tastatore B042
Tracer Point B042
Taster B042
Palpeur B042
Palpador B042

STANDARD

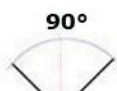

0.45 mm

RIC01793B
Fresino HB020
Cutter HB020
Fräser HB020
Fraise HB020
Fresa HB020



RIC01794B
Tastatore B020
Tracer Point B020
Taster B020
Palpeur B020
Palpador B020



303/304/305



**T-REX
T-REX ADVANCE**



PUNTO

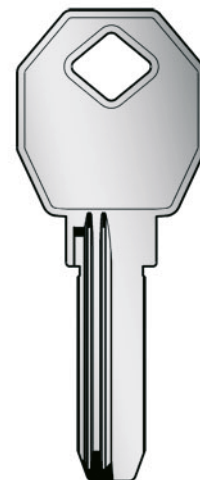

KEYLINE

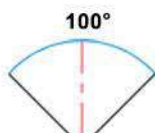

0.4 mm

RIC05264B
Fresino V007
Cutter V007
Fräser V007
Fraise V007
Fresa V007
OPTIONAL

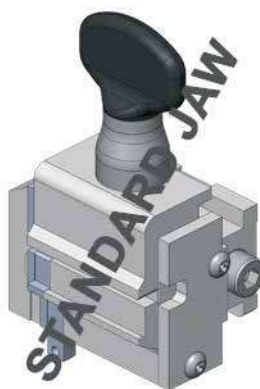

NINJA TOTAL



NINJA VORTEX



VERSA



AS37HH



NINJA VORTEX



VERSA

OPTIONAL

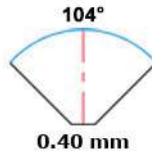

RIC06370B
 Fresino V025
 Cutter V025
 Fräser V025
 Fraise V025
 Fresa V025

OPZ06039B
 Morsetto C08
 Jaw C08
 Spannbacke C08
 Étau C08
 Mordaza C08

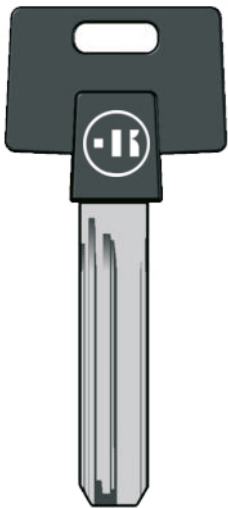

ML4P



303/304/305



T-REX
 T-REX ADVANCE



PUNTO

STANDARD

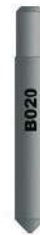
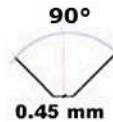

RIC01793B
 Fresino HB020
 Cutter HB020
 Fräser HB020
 Fraise HB020
 Fresa HB020

RIC01794B
 Tastatore B020
 Tracer Point B020
 Taster B020
 Palpeur B020
 Palpador B020

TO
FIT :

DEFEND LOCK (CZ)

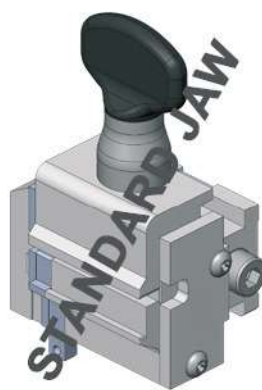
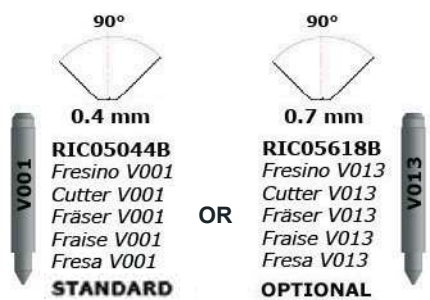

NINJA TOTAL



NINJA VORTEX



VERSA

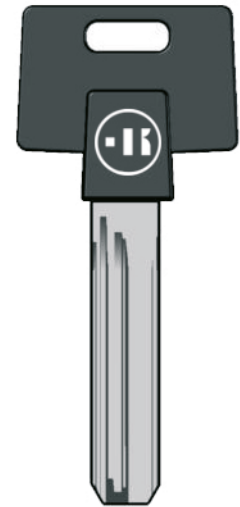

TO
FIT :

DELCA (GR)

OPTIONAL

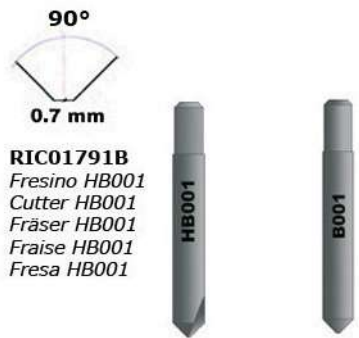

RIC01791B
 Fresino HB001
 Cutter HB001
 Fräser HB001
 Fraise HB001
 Fresa HB001

RIC01792B
 Tastatore B001
 Tracer Point B001
 Taster B001
 Palpeur B001
 Palpador B001

STANDARD



RIC01793B
 Fresino HB020
 Cutter HB020
 Fräser HB020
 Fraise HB020
 Fresa HB020

RIC01794B
 Tastatore B020
 Tracer Point B020
 Taster B020
 Palpeur B020
 Palpador B020



303/304/305



**T-REX
T-REX ADVANCE**



PUNTO

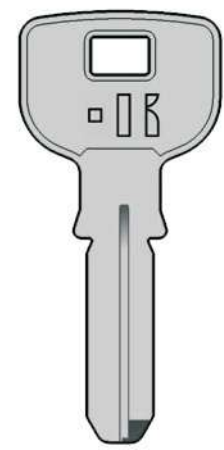

TO FIT: **DIERRE (I)**

NEW POWER

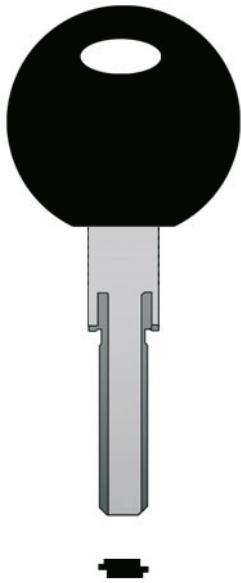

NINJA TOTAL



NINJA VORTEX



VERSA

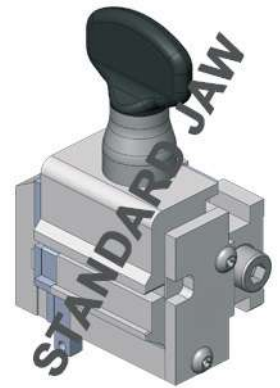
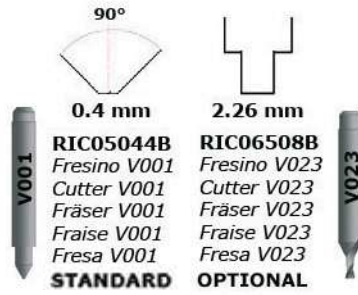

TO FIT: **DOM (D)**

IXDAS



NINJA TOTAL



NINJA VORTEX



VERSA

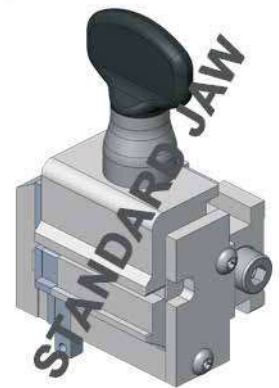

OPTIONAL

OPZ09553B

Morsetto Z23 per chiavi DOM
Jaw Z23 for DOM Keys
Spannbacke Z23 für DOM-Schlüssel
Étau Z23 pour clés DOM
Mordaza Z23 para llaves DOM

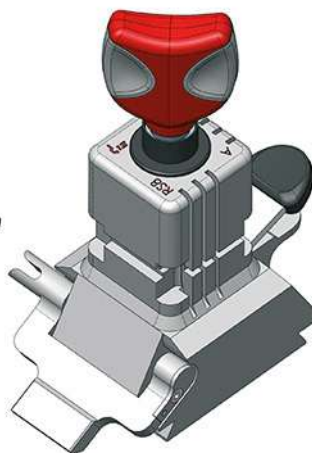

DEZMO

RS8

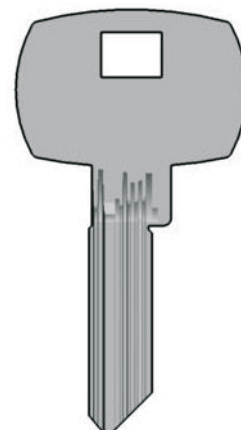

OPTIONAL

OPZ07332B

Morsetto C14
Jaw C14
Spannbacke C14
Étau C14
Mordaza C14

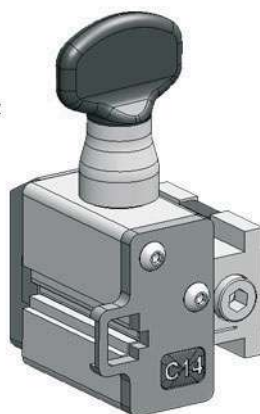

96°



0.4 mm



RIC05262B

Fresino V006
Cutter V006
Fräser V006
Fraise V006
Fresa V006



NINJA TOTAL



NINJA VORTEX



VERSA



TO FIT: **DOM (D)**

IXEZ

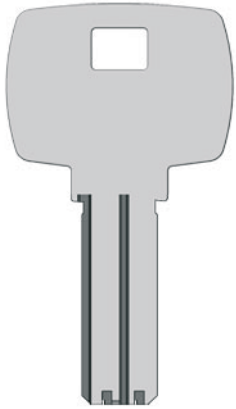

 (51)



NINJA TOTAL



NINJA VORTEX



VERSA

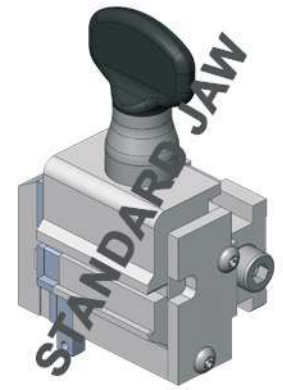
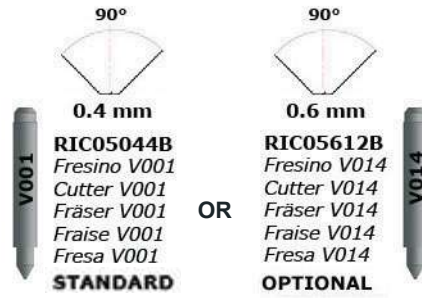

TO FIT: **DOM (D)**

IX6 SR

IX5DAS

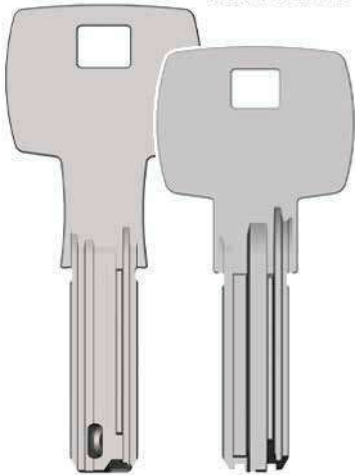

(132)  (038)
 (232) 
 (233)

(038) (132)
 (061) (230)
 (101) (234)
 (115) (240)
 (128) (241)
 (130)



NINJA TOTAL



NINJA VORTEX



VERSA

OPTIONAL



OPZ05701B
 Morsetto C03
 Jaw C03
 Spannbacke C03
 Étau C03
 Mordaza C03

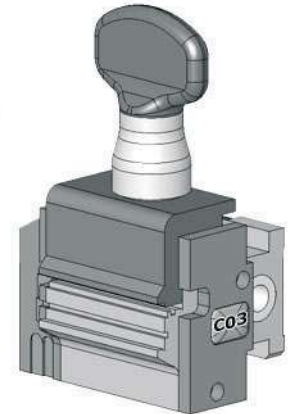

OPTIONAL

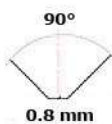

RIC01781B
Fresino HB015
Cutter HB015
Fräser HB015
Fraise HB015
Fresa HB015



RIC01782B
Tastatore B015
Tracer Point B015
Taster B015
Palpeur B015
Palpador B015

STANDARD

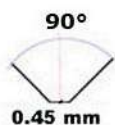

RIC01793B
Fresino HB020
Cutter HB020
Fräser HB020
Fraise HB020
Fresa HB020



RIC01794B
Tastatore B020
Tracer Point B020
Taster B020
Palpeur B020
Palpador B020



303/304/305





**T-REX
T-REX ADVANCE**

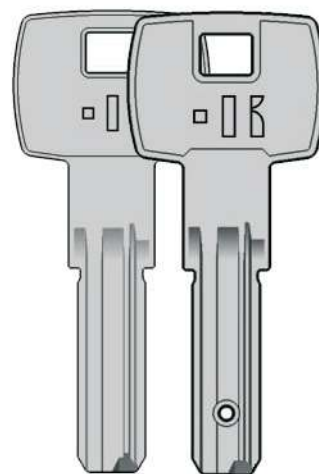

PUNTO

**IX 5
IX5 KG**



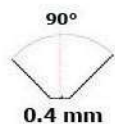

DO120 DO100

DO24 DO100X

prof. 048,069,100,102

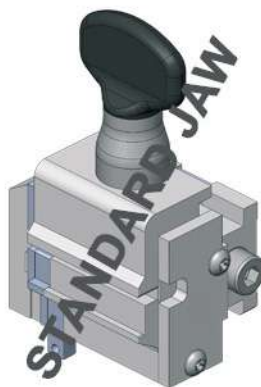

RIC05044B
Fresino V001
Cutter V001
Fräser V001
Fraise V001
Fresa V001
STANDARD



NINJA TOTAL



NINJA VORTEX



VERSA

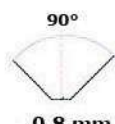

RIC06104B
Fresino V021
Cutter V021
Fräser V021
Fraise V021
Fresa V021
OPTIONAL

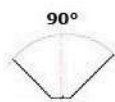

RIC06368B
Fresino V022
Cutter V022
Fräser V022
Fraise V022
Fresa V022
OPTIONAL



TO FIT: **DOM (D)**

**SIGMA
SIGMA Plus**

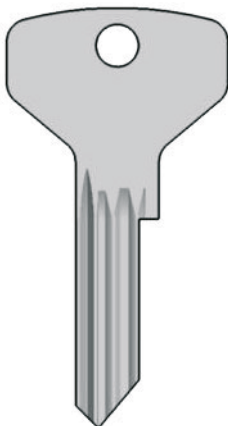

(145)



NINJA TOTAL



NINJA VORTEX



VERSA

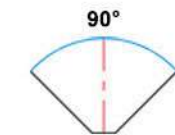

0.4 mm



RIC05044B
Fresino V001
Cutter V001
Fräser V001
Fraise V001
Fresa V001
STANDARD

OR

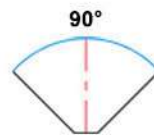

0.7 mm



RIC05618B
Fresino V013
Cutter V013
Fräser V013
Fraise V013
Fresa V013
OPTIONAL

FOR EDGE CUT

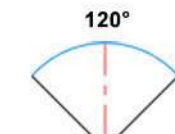

0.3 mm



RIC05272B
Fresino V011
Cutter V011
Fräser V011
Fraise V011
Fresa V011
OPTIONAL

OR

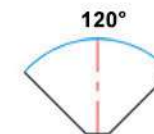

0.8 mm



RIC07726B
Fresino V034
Cutter V034
Fräser V034
Fraise V034
Fresa V034
OPTIONAL

FOR DIMPLE CUT

OPZ07204B
Morsetto C12
Jaw C12
Spannbacke C12
Étau C12
Mordaza C12
OPTIONAL



TO FIT: **DOM (D)**

**IX 6
IX 6KG 3A**



(121)
(102)
(093)



303/304/305



**T-REX
T-REX ADVANCE**



PUNTO

OPTIONAL

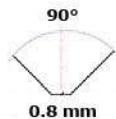

0.8 mm

RIC01781B
Fresino HB015
Cutter HB015
Fräser HB015
Fraise HB015
Fresa HB015



RIC01782B
Tastatore B015
Tracer Point B015
Taster B015
Palpeur B015
Palpador B015



OPZ03712B
Adattatori per chiavi DOM
Adaptors for DOM keys
Adapters für DOM Schlüssel
Adaptateurs pour clés DOM
Adaptadores para llaves DOM

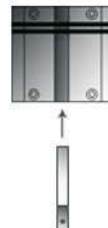

TO
FIT :

DOM (D)

OPTIONAL

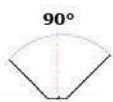

90°
0.8 mm

RIC06104B
Fresino V021
Cutter V021
Fräser V021
Fraise V021
Fresa V021



OPZ05611B
Morsetto C02
Jaw C02
Spannbacke C02
Étau C02
Mordaza C02

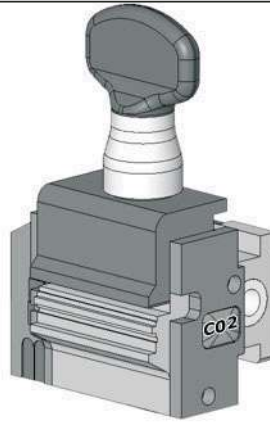

NINJA TOTAL



NINJA VORTEX



VERSA

IX 6
IX 6KG 3A

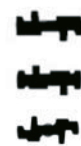



(121)
(102)
(093)

TO
FIT :

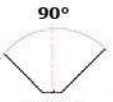

DOM (D)

OPTIONAL



90°
0.8 mm

RIC01781B
Fresino HB015
Cutter HB015
Fräser HB015
Fraise HB015
Fresa HB015



RIC01782B
Tastatore B015
Tracer Point B015
Taster B015
Palpeur B015
Palpador B015

STANDARD

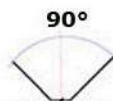

90°
0.45 mm

RIC01793B
Fresino HB020
Cutter HB020
Fräser HB020
Fraise HB020
Fresa HB020

RIC01794B
Tastatore B020
Tracer Point B020
Taster B020
Palpeur B020
Palpador B020



303/304/305





**T-REX
T-REX ADVANCE**



PUNTO

DS10
DS15

IX10

TO FIT: DOM (D)

DS10
DS15



IX10



NINJA TOTAL



NINJA VORTEX



VERSA

STANDARD

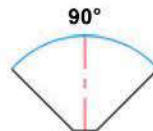

0.4 mm

RIC05044B
Fresino V001
Cutter V001
Fräser V001
Fraise V001
Fresa V001

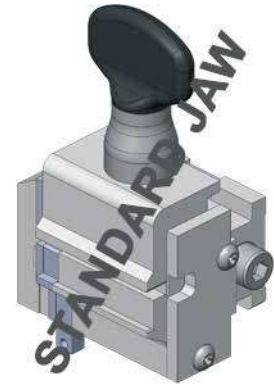

TO FIT: DOM (D)

IXGAMMA

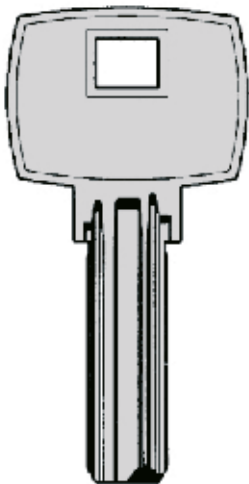

prof. 153, 154, 155
WN 6454



NINJA VORTEX



VERSA

OPTIONAL

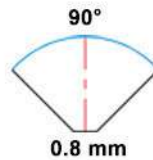

0.8 mm



RIC06104B
Fresino V021
Cutter V021
Fräser V021
Fraise V021
Fresa V021

OPZ07800B
Morsetto C15
Jaw C15
Spannbacke C15
Étau C15
Mordaza C15



TO
FIT :

DOM (D)

OPTIONAL



RIC06104B
Fresino V021
Cutter V021
Fräser V021
Fraise V021
Fresa V021

OPZ10401B
Morsetto C36
Jaw C36
Spannbacke C36
Étau C36
Mordaza C36



NINJA TOTAL



NINJA VORTEX



VERSA

IXGAMMA

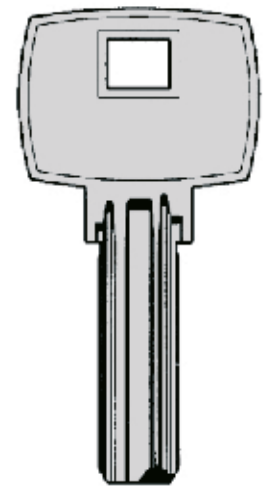

prof. 153, 154, 155
WN 6454



TO
FIT :

DOM (D)

OPTIONAL



RIC05266B
Fresino V008
Cutter V008
Fräser V008
Fraise V008
Fresa V008

OPZ06039B
Morsetto C08
Jaw C08
Spannbacke C08
Étau C08
Mordaza C08



NINJA VORTEX



VERSA

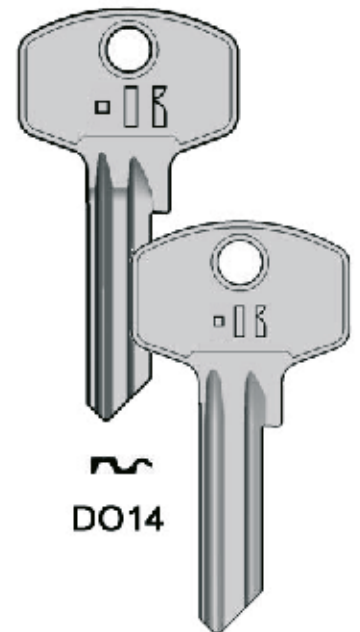

DO14

DO220

TO FIT: **DOM (D)**

IX SAT

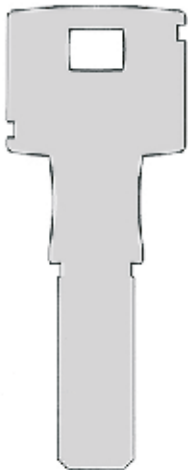

prof. 169,170,171,172



NINJA TOTAL



NINJA VORTEX



VERSA

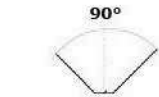

0.8 mm



RIC06104B
Fresino V021
Cutter V021
Fräser V021
Fraise V021
Fresa V021
OPTIONAL

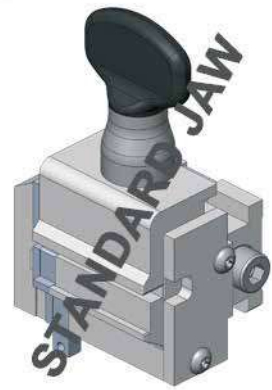

TO FIT: **DOMUS (GR)**

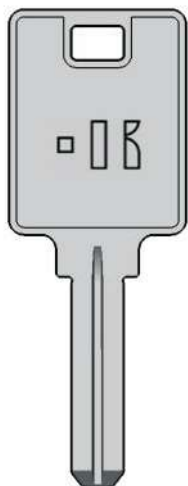

DS1



303/304/305



T-REX
T-REX ADVANCE



PUNTO

STANDARD

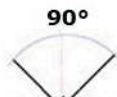

0.45 mm

RIC01793B
Fresino HB020
Cutter HB020
Fräser HB020
Fraise HB020
Fresa HB020



RIC01794B
Tastatore B020
Tracer Point B020
Taster B020
Palpeur B020
Palpador B020

TO
FIT :

DOMUS (GR)

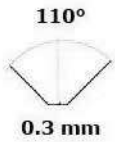

RIC05270B
 Fresino V010
 Cutter V010
 Fräser V010
 Fraise V010
 Fresa V010
OPTIONAL

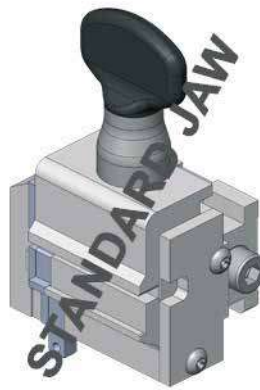

NINJA TOTAL



NINJA VORTEX



VERSA

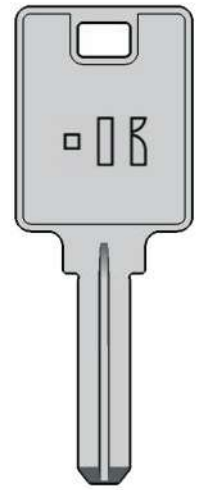

DS1

TO
FIT :

ELZETT (H)

OPTIONAL

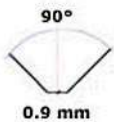

RIC01775B
 Fresino HB005
 Cutter HB005
 Fräser HB005
 Fraise HB005
 Fresa HB005



RIC01776B
 Tastatore B005
 Tracer Point B005
 Taster B005
 Palpeur B005
 Palpador B005



303/304/305



**T-REX
T-REX ADVANCE**



PUNTO



ELZETT

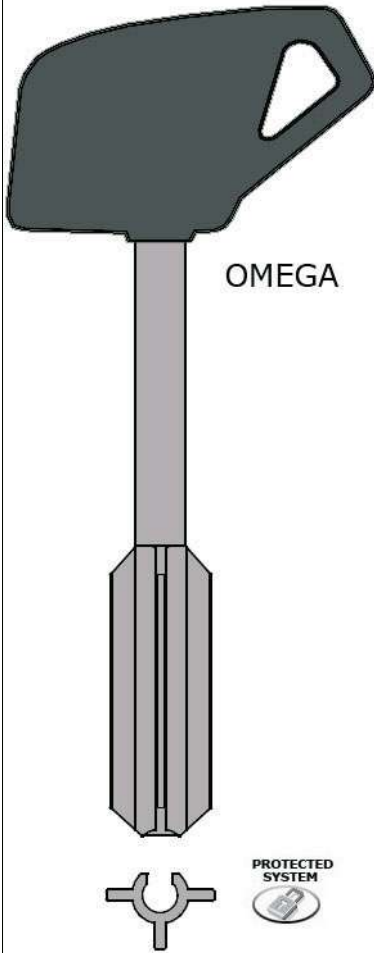

NINJA VORTEX



VERSA



DEZMO



NINJA LASER



NINJA TOTAL



NINJA NINJA DARK

OPTIONAL

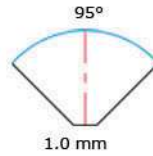

RIC08161B
*Fresino V039
 Cutter V039
 Fräser V039
 Fraise V039
 Fresa V039*

OPZ08107B
*Morsetto C16
 Jaw C16
 Spannbacke C16
 Étau C16
 Mordaza C16*



OPTIONAL

OPZ09456B
*Adattatore B14 per chiavi Esety
 Adaptor B14 for Esety keys
 Adapter B14 für Esety-Schlüssel
 Adaptateur B14 pour clés Esety
 Adaptador B14 para llaves Esety*



OPTIONAL



2 mm

RIC01816B
Fresino HC044
Cutter HC044
Fräser HC044
Fraise HC044
Fresa HC044



RIC01817B
Tastatore C044
Tracer Point C044
Taster C044
Palpeur C044
Palpador C044



303/304/305



**T-REX
T-REX ADVANCE**



PUNTO



EU8

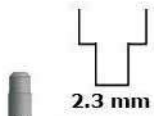

2.3 mm

RIC05506B
Fresino V016
Cutter V016
Fräser V016
Fraise V016
Fresa V016
OPTIONAL

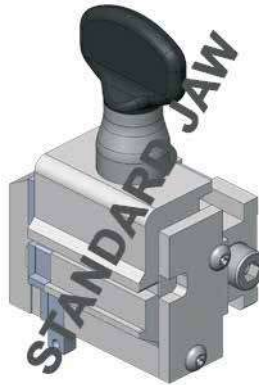

NINJA TOTAL



NINJA VORTEX



VERSA

ICS

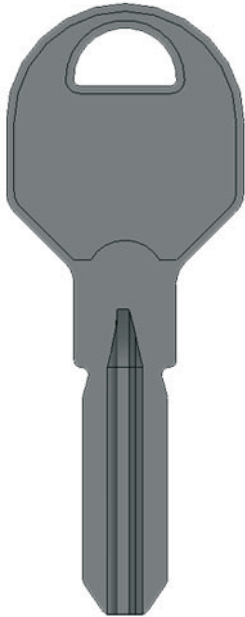

303/304/305



**T-REX
T-REX ADVANCE**



PUNTO



NINJA TOTAL



NINJA VORTEX



VERSA

OPTIONAL



2 mm

RIC01816B
Fresino HC044
Cutter HC044
Fräser HC044
Fraise HC044
Fresa HC044



RIC01817B
Tastatore C044
Tracer Point C044
Taster C044
Palpeur C044
Palpador C044



2.00 mm

RIC07786B
Fresino V037
Cutter V037
Fräser V037
Fraise V037
Fresa V037
OPTIONAL

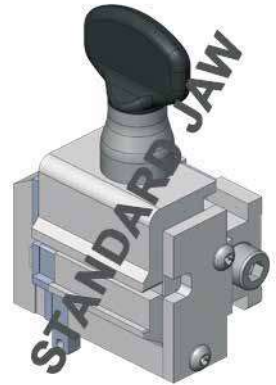

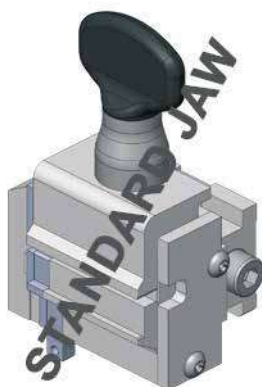

NINJA TOTAL



NINJA VORTEX



VERSA



VERSA

3KS
4KS

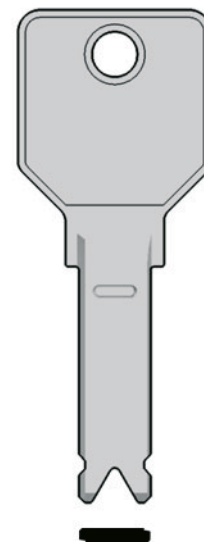

OPTIONAL

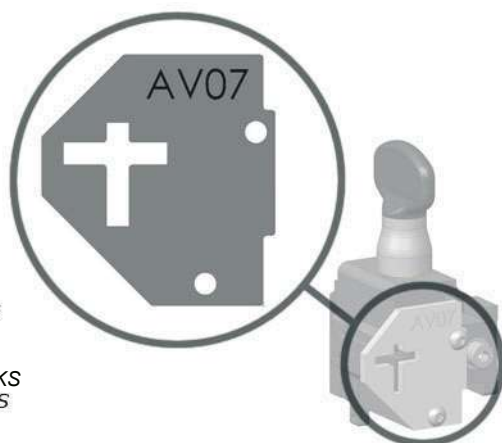

OPZ08843B
Adattatore AV07 per EVVA 3KS
Adaptor AV07 for EVVA 3KS
Adapter AV07 für EVVA 3KS
Adaptateur AV07 pour EVVA 3KS
Adaptador AV07 para EVVA 3KS

DPI/DPS
DPX/EPS



NINJA VORTEX



VERSA

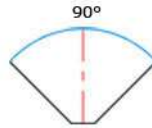

0.40 mm



RIC05044B
Fresino V001
Cutter V001
Fräser V001
Fraise V001
Fresa V001
STANDARD

OR

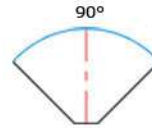

0.70 mm



RIC05618B
Fresino V013
Cutter V013
Fräser V013
Fraise V013
Fresa V013
OPTIONAL

OPZ06039B
Morsetto C08
Jaw C08
Spannbacke C08
Étau C08
Mordaza C08
OPTIONAL



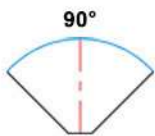

0.4 mm

RIC05044B
Fresino V001
Cutter V001
Fräser V001
Fraise V001
Fresa V001

STANDARD



OPZ06039B
Morsetto C08
Jaw C08
Spannbacke C08
Étau C08
Mordaza C08

OPTIONAL



NINJA VORTEX



VERSA

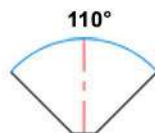

0.3 mm

RIC05270B
Fresino V010
Cutter V010
Fräser V010
Fraise V010
Fresa V010

OPTIONAL

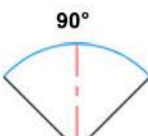

0.7 mm

RIC05618B
Fresino V013
Cutter V013
Fräser V013
Fraise V013
Fresa V013

OPTIONAL



EV69-A
EV10-A
EV11-A
EV5-A
EV22S-A
EV15-A
EV13-A
EV12-A



EV8S



EV10-FJ
EV10-F
EV5-F
EV69-F

DS-15 2A

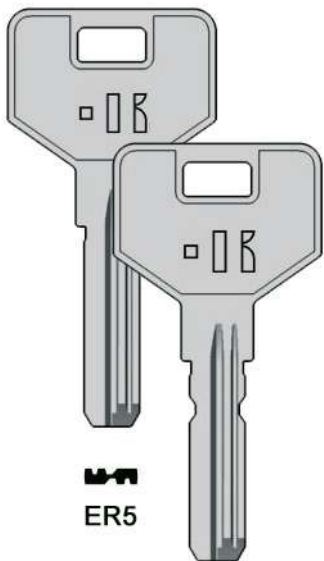

ER5

ER4



303/304/305



**T-REX
T-REX ADVANCE**



PUNTO



NINJA TOTAL



NINJA VORTEX



VERSA

OPTIONAL

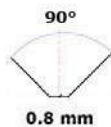

0.8 mm

RIC01783B
Fresino HB026
Cutter HB026
Fräser HB026
Fraise HB026
Fresa HB026



RIC01784B
Tastatore B026
Tracer Point B026
Taster B026
Palpeur B026
Palpador B026

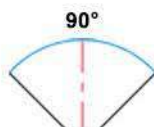

0.4 mm

RIC05044B
Fresino V001
Cutter V001
Fräser V001
Fraise V001
Fresa V001
STANDARD



OR

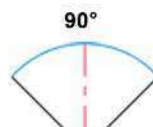

0.6 mm

RIC05612B
Fresino V014
Cutter V014
Fräser V014
Fraise V014
Fresa V014
OPTIONAL

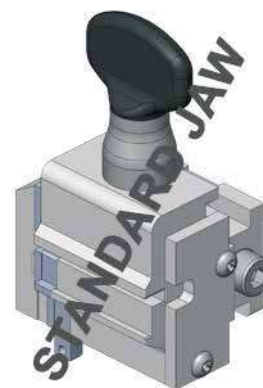

OPTIONAL

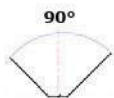

0.8 mm

RIC01783B
Fresino HB026
Cutter HB026
Fräser HB026
Fraise HB026
Fresa HB026



RIC01784B
Tastatore B026
Tracer Point B026
Taster B026
Palpeur B026
Palpador B026



303/304/305



**T-REX
T-REX ADVANCE**



PUNTO

DS10
DS15

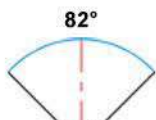
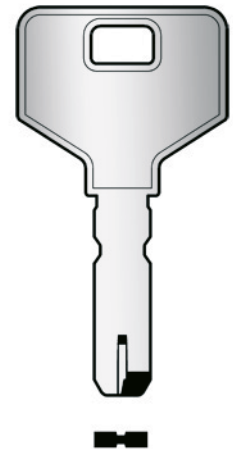

0.5 mm

RIC05084B
Fresino V004
Cutter V004
Fräser V004
Fraise V004
Fresa V004
OPTIONAL

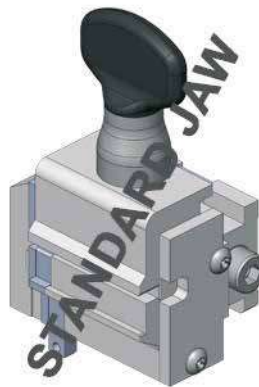

NINJA TOTAL



NINJA VORTEX



VERSA

FAB RS 200

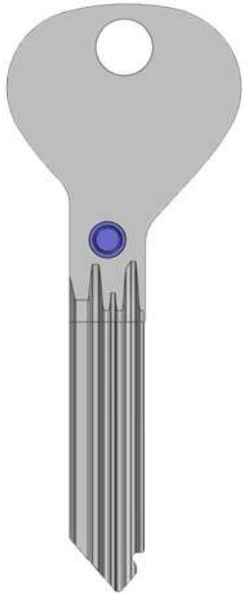

DEZMO

OPTIONAL

OPZ09241B

Morsetto Z22 per chiavi Fab
Jaw Z22 for Fab keys
Spannbacke Z22 für Fab Schlüssel
Étau Z22 pour clés Fab
Mordaza Z22 para llaves Fab

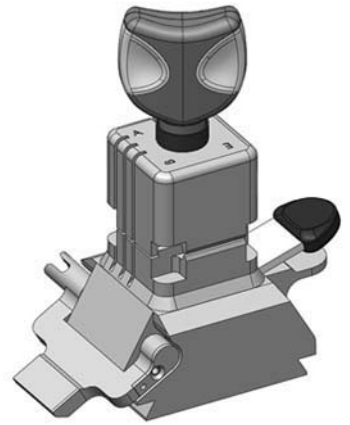

DROMO

OPTIONAL

OPZ09427B

Kit adattatore Dromo per Fab RS 200
Dromo Adaptor Kit for Fab RS 200
Dromo Adapter Kit für Fab RS 200 Schlüssel
Kit adaptateur Dromo pour clés Fab RS 200
Kit adaptador Dromo para llaves Fab RS 200

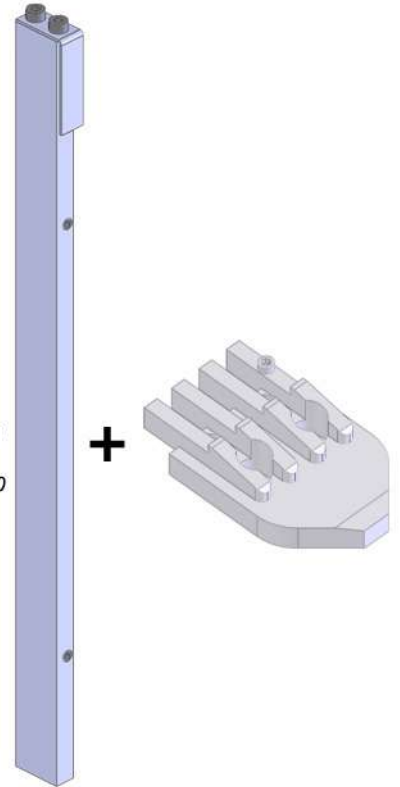

Per i Dromo con matricola inferiore a 17810009999, contattare Keyline.
For Dromos with SN before 17810009999, please contact Keyline.
Für Dromo mit Seriennummer unter Nummer 17810009999, setzen Sie sich mit Keyline in Verbindung.
Pour le Dromo avec matricule inférieure à 17810009999, nous vous prions de contacter Keyline.
Para los Dromo con matricula inferior a 17810009999, contactar Keyline.

OPTIONAL

OPZ09330B

Morsetto N22 per chiavi Fab
Jaw N22 for Fab keys
Spannbacke N22 für Fab Schlüssel
Étau N22 pour clés Fab
Mordaza N22 para llaves Fab



NINJA LASER



NINJA TOTAL



**NINJA
NINJA DARK**

FAB RS 200

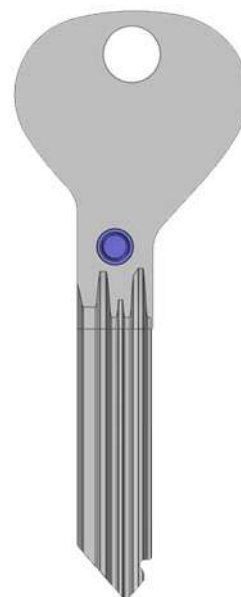

TO
FIT: **FAB (CZ)**



NINJA TOTAL



NINJA VORTEX



VERSA

OPTIONAL



0.8 mm

RIC06368B
Fresino V022
Cutter V022
Fräser V022
Fraise V022
Fresa V022

OPZ10427B

Morsetto C39
Jaw C39
Spannbacke C39
Étau C39
Mordaza C39



TO
FIT: **FAC (E)**

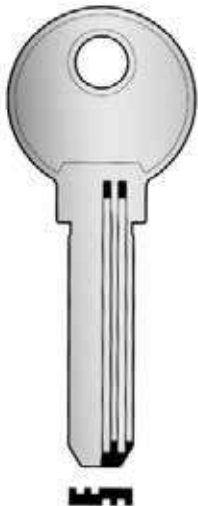

303/304/305



T-REX
T-REX ADVANCE



PUNTO

STANDARD

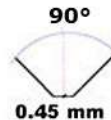

0.45 mm

RIC01793B
Fresino HB020
Cutter HB020
Fräser HB020
Fraise HB020
Fresa HB020



RIC01794B
Tastatore B020
Tracer Point B020
Taster B020
Palpeur B020
Palpador B020

TO
FIT :

FAC (E)

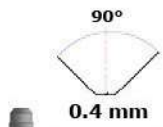

0.4 mm

RIC05044B
Fresino V001
Cutter V001
Fräser V001
Fraise V001
Fresa V001
STANDARD

OR

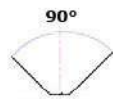

0.7 mm

RIC05618B
Fresino V013
Cutter V013
Fräser V013
Fraise V013
Fresa V013
OPTIONAL

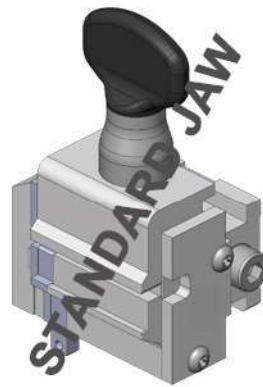

NINJA TOTAL



NINJA VORTEX



VERSA



TO
FIT :

FAYN (TR)

OPTIONAL

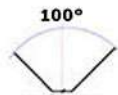

0.7 mm

RIC01789B
Fresino HB042
Cutter HB042
Fräser HB042
Fraise HB042
Fresa HB042



RIC01790B
Tastatore B042
Tracer Point B042
Taster B042
Palpeur B042
Palpador B042



303/304/305



**T-REX
T-REX ADVANCE**



PUNTO



TO FIT: FAYN (TR)



NINJA TOTAL



NINJA VORTEX



VERSA

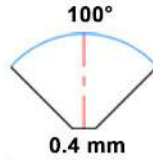

RIC05264B
Fresino V007
Cutter V007
Fräser V007
Fraise V007
Fresa V007
OPTIONAL

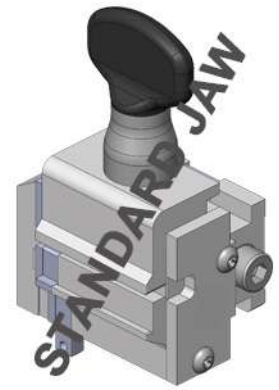

TO FIT: FCV (D)

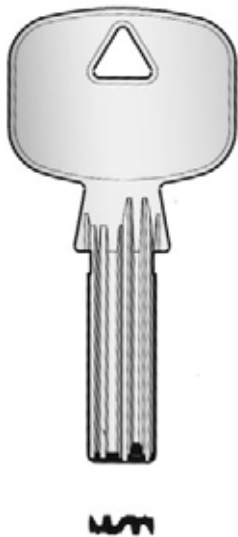

303/304/305



**T-REX
T-REX ADVANCE**



PUNTO

STANDARD

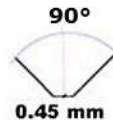

RIC01793B
Fresino HB020
Cutter HB020
Fräser HB020
Fraise HB020
Fresa HB020



RIC01794B
Tastatore B020
Tracer Point B020
Taster B020
Palpeur B020
Palpador B020

TO
FIT :

FCV (D)

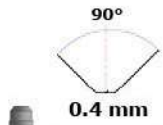

0.4 mm

RIC05044B
Fresino V001
Cutter V001
Fräser V001
Fraise V001
Fresa V001
STANDARD

OR

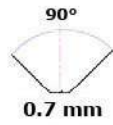

0.7 mm

RIC05618B
Fresino V013
Cutter V013
Fräser V013
Fraise V013
Fresa V013
OPTIONAL

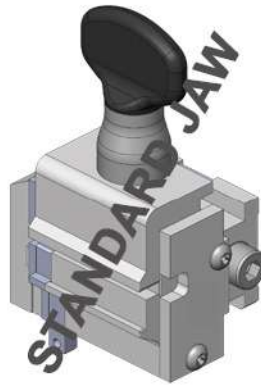

NINJA TOTAL



NINJA VORTEX



VERSA

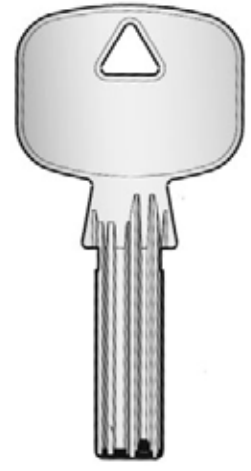

W

TO
FIT :

FIAM (I)

OPTIONAL

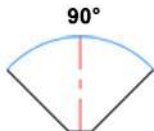

1,0 mm

RIC01822B
Fresino HB043
Cutter HB043
Fräser HB043
Fraise HB043
Fresa HB043



RIC01823B
Tastatore B043
Tracer Point B043
Taster B043
Palpeur B043
Palpador B043



303/304/305



**T-REX
T-REX ADVANCE**



PUNTO

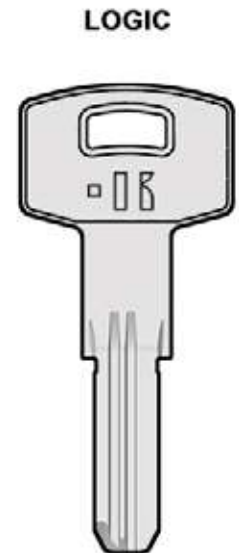

FIA3S

TO FIT: **FIAM (I)**

LOGIC

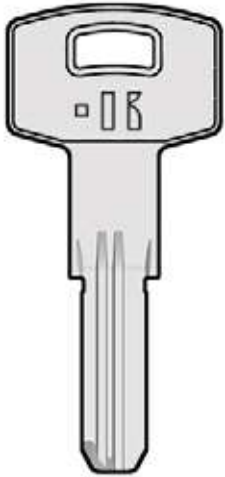

FIA3S



NINJA TOTAL



NINJA VORTEX



VERSA

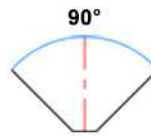

0.4 mm



RIC05044B
Fresino V001
Cutter V001
Fräser V001
Fraise V001
Fresa V001
STANDARD

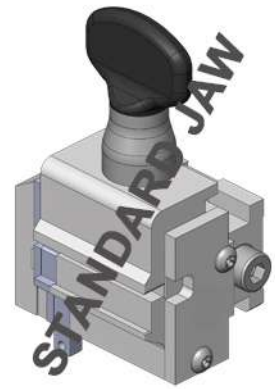

OPZ10584B
Adattatore AV11
Adaptor AV11
Adapter AV11
Adaptateur AV11
Adaptador AV11
OPTIONAL



TO FIT: **FICHET (F)**

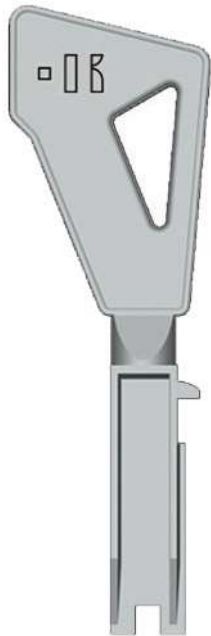

FIC3



303/304/305



**T-REX
T-REX ADVANCE**

OPTIONAL



2.5 mm

RIC01810B
Fresino HC011
Cutter HC011
Fräser HC011
Fraise HC011
Fresa HC011



RIC01811B
Tastatore C011
Tracer Point C011
Taster C011
Palpeur C011
Palpador C011



OPZ02653B
Adattatori per chiavi Fichet
Adaptors for Fichet keys
Adapters für Fichet-Schlüssel
Adaptateurs pour clés Fichet
Adapadores para llaves Fichet

STANDARD

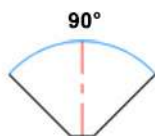

0.45 mm

RIC01793B

*Fresino HB020
Cutter HB020
Fräser HB020
Fraise HB020
Fresa HB020*



RIC01794B

*Tastatore B020
Tracer Point B020
Taster B020
Palpeur B020
Palpador B020*

OPTIONAL

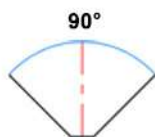

0.9 mm

RIC01775B

*Fresino HB005
Cutter HB005
Fräser HB005
Fraise HB005
Fresa HB005*



RIC01776B

*Tastatore B005
Tracer Point B005
Taster B005
Palpeur B005
Palpador B005*



303/304/305



**T-REX
T-REX ADVANCE**



PUNTO

**ATLANTIC
TRANSIT**

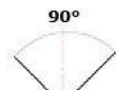
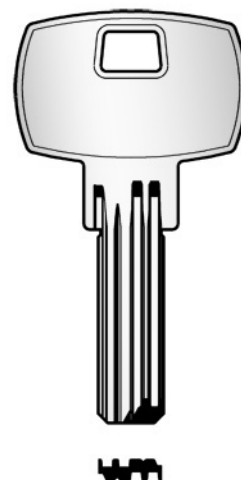

0.4 mm

RIC05044B
*Fresino V001
Cutter V001
Fräser V001
Fraise V001
Fresa V001*



OR

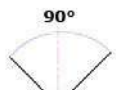

0.6 mm

RIC05612B
*Fresino V014
Cutter V014
Fräser V014
Fraise V014
Fresa V014*

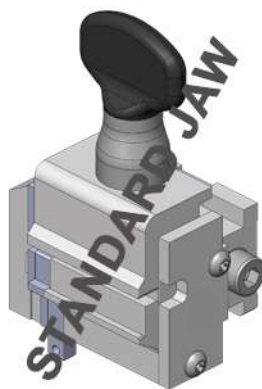

NINJA TOTAL



NINJA VORTEX



VERSA

TO FIT: **GE-GE (A)**

7p Extra SE



NINJA VORTEX



VERSA

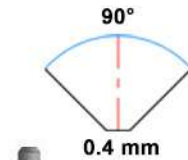

RIC05044B
Fresino V001
Cutter V001
Fräser V001
Fraise V001
Fresa V001
STANDARD
FOR EDGE CUT

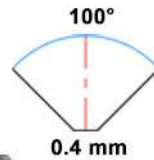

RIC05264B
Fresino V007
Cutter V007
Fräser V007
Fraise V007
Fresa V007
OPTIONAL
FOR DIMPLE CUT

OPZ06039B
Morsetto C08
Jaw C08
Spannbacke C08
Étau C08
Mordaza C08
OPTIONAL



TO FIT: **GERA (D)**

WS
WS X
WS XP



WSG PLUS
WSG X
WSG XP



NINJA TOTAL



NINJA VORTEX



VERSA

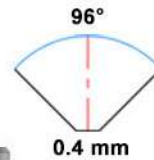

RIC05262B
Fresino V006
Cutter V006
Fräser V006
Fraise V006
Fresa V006
OPTIONAL

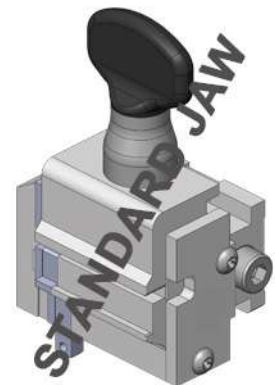

TO
FIT :

GIUSSANI (I)

OPTIONAL



1.5 mm

RIC01820B
Fresino HC003
Cutter HC003
Fräser HC003
Fraise HC003
Fresa HC003



RIC01813B
Tastatore C003
Tracer Point C003
Taster C003
Palpeur C003
Palpador C003

303/304/305



**T-REX
T-REX ADVANCE**



PUNTO



GIS17

TO
FIT :

GOAL (J)

STANDARD



0.45 mm

RIC01793B
Fresino HB020
Cutter HB020
Fräser HB020
Fraise HB020
Fresa HB020



RIC01794B
Tastatore B020
Tracer Point B020
Taster B020
Palpeur B020
Palpador B020

303/304/305



**T-REX
T-REX ADVANCE**



PUNTO

V18
V9



KL109

TO FIT: **GOAL (J)**

V18
V9



KL109



NINJA TOTAL



NINJA VORTEX



VERSA

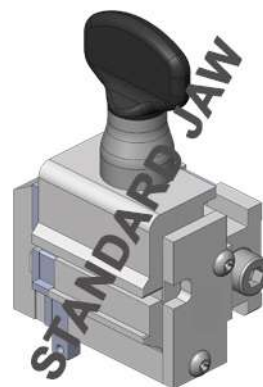

OR



OR



TO FIT: **ICSA (I)**



IC1



303/304/305



**T-REX
T-REX ADVANCE**



PUNTO

STANDARD



RIC01794B
Tastatore B020
Tracer Point B020
Taster B020
Palpeur B020
Palpador B020

OPTIONAL

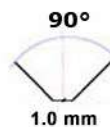

RIC01823B
Tastatore B043
Tracer Point B043
Taster B043
Palpeur B043
Palpador B043

TO
FIT :

ICSA (I)

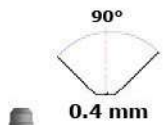

0.4 mm

RIC05044B
Fresino V001
Cutter V001
Fräser V001
Fraise V001
Fresa V001
STANDARD

OR

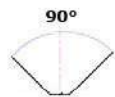

0.7 mm

RIC05618B
Fresino V013
Cutter V013
Fräser V013
Fraise V013
Fresa V013
OPTIONAL

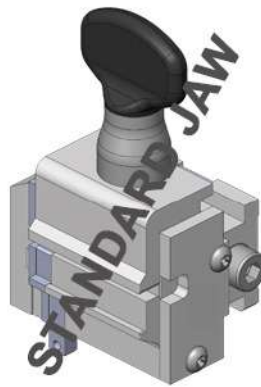

NINJA TOTAL



NINJA VORTEX



VERSA



IC1

TO
FIT :

IFAM (E)

STANDARD



0.45 mm

RIC01793B
Fresino HB020
Cutter HB020
Fräser HB020
Fraise HB020
Fresa HB020



RIC01794B
Tastatore B020
Tracer Point B020
Taster B020
Palpeur B020
Palpador B020



303/304/305



**T-REX
T-REX ADVANCE**



PUNTO



TO FIT: **IFAM (E)**



NINJA TOTAL



NINJA VORTEX



VERSA

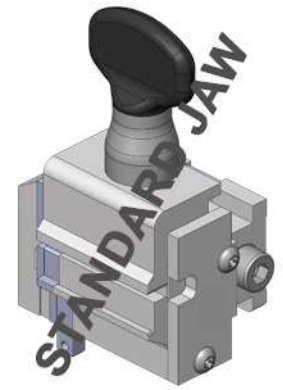
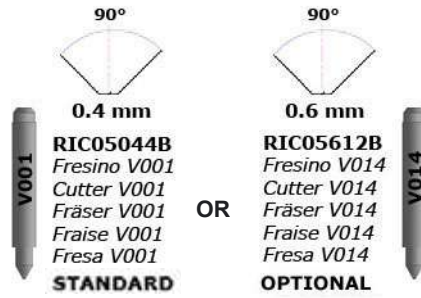

TO FIT: **INAHO (J)**

6+7P



NINJA TOTAL



NINJA VORTEX



VERSA



OPZ07800B
Morsetto C15
Jaw C15
Spannbacke C15
Étau C15
Mordaza C15
OPTIONAL



OPTIONAL

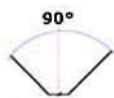

0.6 mm

RIC01785B
Fresino HB039
Cutter HB039
Fräser HB039
Fraise HB039
Fresa HB039



RIC01786B
Tastatore B039
Tracer Point B039
Taster B039
Palpeur B039
Palpador B039



303/304/305



**T-REX
T-REX ADVANCE**



PUNTO

ISR100WEB



4.0 mm

RIC05044B
Fresino V001
Cutter V001
Fräser V001
Fraise V001
Fresa V001
STANDARD



OPZ05701B
Morsetto C03
Jaw C03
Spannbacke C03
Étau C03
Mordaza C03
OPTIONAL



NINJA TOTAL



NINJA VORTEX



VERSA

R6
R7

R11
R50

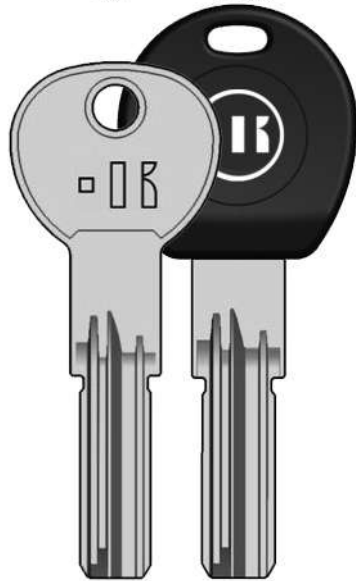

ISE14
ISE15
ISE17



ISE14P
ISE15P
ISE17P



303/304/305



**T-REX
T-REX ADVANCE**



PUNTO

STANDARD

90°



0.45 mm

RIC01793B

*Fresino HB020
Cutter HB020
Fräser HB020
Fraise HB020
Fresa HB020*



RIC01794B

*Tastatore B020
Tracer Point B020
Taster B020
Palpeur B020
Palpador B020*

OPTIONAL

90°



0.6 mm

RIC01785B

*Fresino HB039
Cutter HB039
Fräser HB039
Fraise HB039
Fresa HB039*



RIC01786B

*Tastatore B039
Tracer Point B039
Taster B039
Palpeur B039
Palpador B039*



NINJA TOTAL



NINJA VORTEX



VERSA

90°



0.4 mm

RIC05044B

*Fresino V001
Cutter V001
Fräser V001
Fraise V001
Fresa V001*



STANDARD

90°

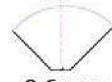

0.6 mm

RIC05612B

*Fresino V014
Cutter V014
Fräser V014
Fraise V014
Fresa V014*



OPTIONAL

OR

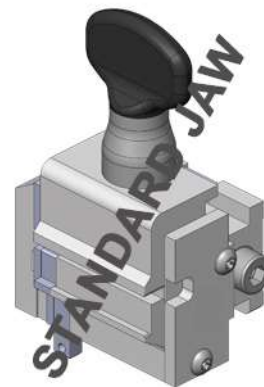

TO
FIT :

ISEO (I)

OPTIONAL

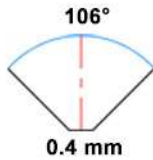

RIC05266B
Fresino V008
Cutter V008
Fräser V008
Fraise V008
Fresa V008

OPZ06039B
Morsetto C08
Jaw C08
Spannbacke C08
Étau C08
Mordaza C08



NINJA VORTEX



VERSA



5 pin
ISE5D
ISE5S
ISE5SM
ISE51
ISE31
ISE2

4 pin
ISE41D
ISE41S
ISE4D
ISE4S

3 pin
ISE3D
ISE3S

TO
FIT :

ITO (TR)

OPTIONAL

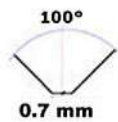

RIC01789B
Fresino HB042
Cutter HB042
Fräser HB042
Fraise HB042
Fresa HB042



RIC01790B
Tastatore B042
Tracer Point B042
Taster B042
Palpeur B042
Palpador B042



303/304/305



**T-REX
T-REX ADVANCE**



PUNTO

I01

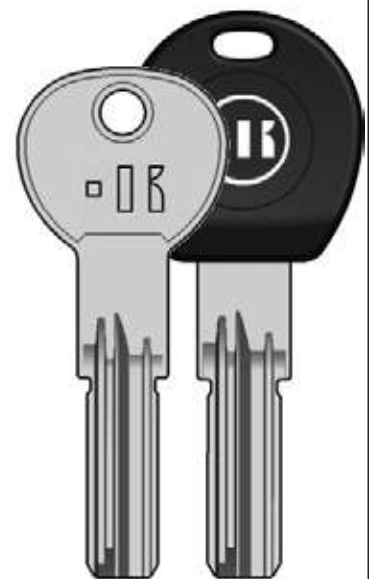

ISE17 ISE17P

TO FIT: ITO (TR)

I01



ISE17 ISE17P



NINJA TOTAL



NINJA VORTEX



VERSA

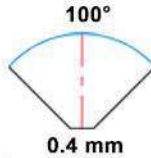

RIC05264B
Fresino V007
Cutter V007
Fräser V007
Fraise V007
Fresa V007
OPTIONAL

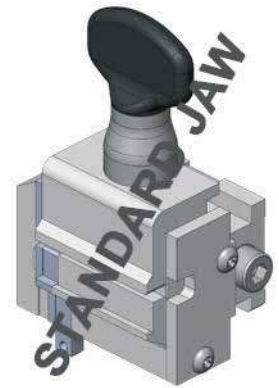

TO FIT: JIS (E)

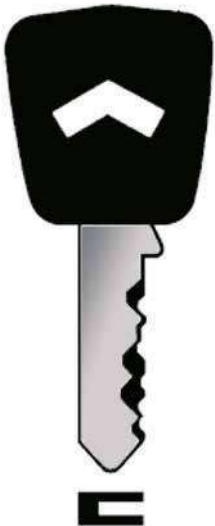

303/304/305



T-REX
T-REX ADVANCE



PUNTO

MJ
Adattatori per chiavi Jis
Adaptors for Jis keys
Adapters für Jis-Schlüssel
Adaptateurs pour clés Jis
Adaptadores para llaves Jis
OPTIONAL



RIC01810B
Fresino HC011
Cutter HC011
Fräser HC011
Fraise HC011
Fresa HC011
STANDARD



RIC01811B
Tastatore C011
Tracer Point C011
Taster C011
Palpeur C011
Palpador C011
STANDARD

OPTIONAL



MK45
Adattatori per chiavi Kaba 45°
Adaptors for Kaba 45° keys
Adapters für Kaba 45°-Schlüssel
Adaptateurs pour clés Kaba 45°
Adaptadores para llaves Kaba 45°



T-REX

KABA 20

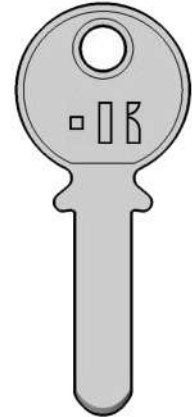

STANDARD



90°

0.45 mm

RIC01793B
Fresino HB020
Cutter HB020
Fräser HB020
Fraise HB020
Fresa HB020



RIC01794B
Tastatore B020
Tracer Point B020
Taster B020
Palpeur B020
Palpador B020

OPTIONAL



90°

0.7 mm

RIC01791B
Fresino HB001
Cutter HB001
Fräser HB001
Fraise HB001
Fresa HB001



RIC01792B
Tastatore B001
Tracer Point B001
Taster B001
Palpeur B001
Palpador B001



303



PUNTO

KA2

OPTIONAL



90°

1.0 mm

RIC01822B
Fresino HB043
Cutter HB043
Fräser HB043
Fraise HB043
Fresa HB043



RIC01823B
Tastatore B043
Tracer Point B043
Taster B043
Palpeur B043
Palpador B043

STANDARD



90°

0.45 mm

RIC01793B
Fresino HB020
Cutter HB020
Fräser HB020
Fraise HB020
Fresa HB020



RIC01794B
Tastatore B020
Tracer Point B020
Taster B020
Palpeur B020
Palpador B020

OPTIONAL



90°

0.7 mm

RIC01791B
Fresino HB001
Cutter HB001
Fräser HB001
Fraise HB001
Fresa HB001



RIC01792B
Tastatore B001
Tracer Point B001
Taster B001
Palpeur B001
Palpador B001



T-REX ADVANCE



304/305

OPTIONAL



90°

1.0 mm

RIC01822B
Fresino HB043
Cutter HB043
Fräser HB043
Fraise HB043
Fresa HB043



RIC01823B
Tastatore B043
Tracer Point B043
Taster B043
Palpeur B043
Palpador B043

KABA 20



KA2



NINJA TOTAL



NINJA VORTEX



VERSA

OPTIONAL

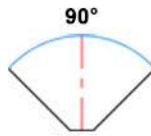

0.8 mm

RIC06368B

*Fresino V022
Cutter V022
Fräser V022
Fraise V022
Fresa V022*



OPZ08506B

*Morsetto C22
Jaw C22
Spannbacke C22
Étau C22
Mordaza C22*

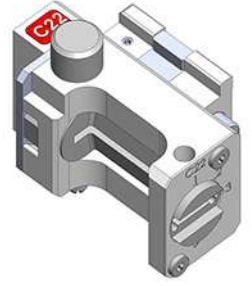

INCLUDED WITH JAW

*Tastatore T005
Tracer Point T005
Taster T005
Palpeur T005
Palpador T005*



OPTIONAL

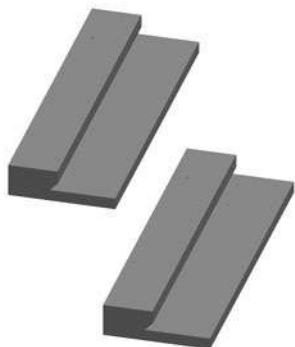

OPZ06644B
Adattatori per Kaba Micro e KYR
Adaptors for Kaba Micro and KYR
Adapters für Kaba Micro und KYR
Adaptateurs pour Kaba Micro et KYR
Adaptadores para Kaba Micro y KYR



303/304/305



**T-REX
T-REX ADVANCE**

KABA MICRO



KA8

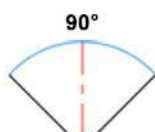

0.4 mm



RIC05044B
Fresino V001
Cutter V001
Fräser V001
Fraise V001
Fresa V001
STANDARD

OPZ07800B
Morsetto C15
Jaw C15
Spannbacke C15
Étau C15
Mordaza C15
OPTIONAL



NINJA TOTAL



NINJA VORTEX



VERSA

KABA 8

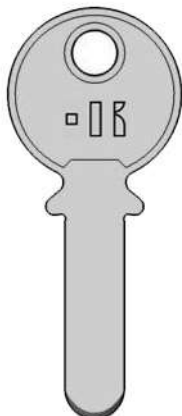

KA1



303/304/305



**T-REX
T-REX ADVANCE**



PUNTO

OPTIONAL

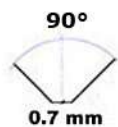

RIC01791B
Fresino HB001
Cutter HB001
Fräser HB001
Fraise HB001
Fresa HB001



RIC01792B
Tastatore B001
Tracer Point B001
Taster B001
Palpeur B001
Palpador B001

STANDARD

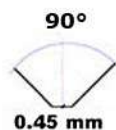

RIC01793B
Fresino HB020
Cutter HB020
Fräser HB020
Fraise HB020
Fresa HB020



RIC01794B
Tastatore B020
Tracer Point B020
Taster B020
Palpeur B020
Palpador B020



NINJA TOTAL



NINJA VORTEX



VERSA

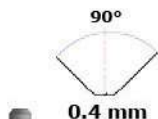

RIC05044B
Fresino V001
Cutter V001
Fräser V001
Fraise V001
Fresa V001
STANDARD



OR

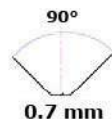

RIC05618B
Fresino V013
Cutter V013
Fräser V013
Fraise V013
Fresa V013
OPTIONAL

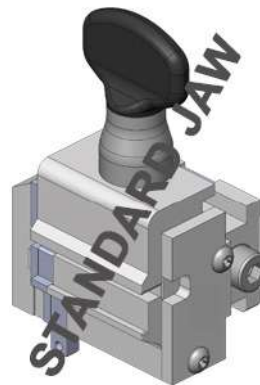

TO
FIT :

KABA (CH)

OPTIONAL

OPZ08505B
Morsetto C21
Jaw C21
Spannbacke C21
Étau C21
Mordaza C21

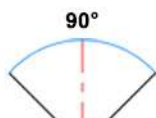
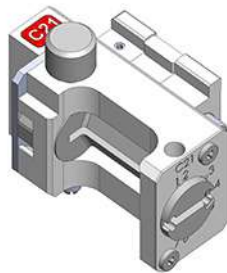

0.56 mm



RIC06581B
Fresino V052
Cutter V052
Fräser V052
Fraise V052
Fresa V052



INCLUDED WITH JAW
Tastatore T005
Tracer Point T005
Taster T005
Palpeur T005
Palpador T005



NINJA TOTAL



NINJA VORTEX



VERSA

EXPER T



TO
FIT :

KABA (CH)

OPTIONAL

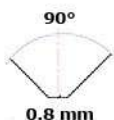

0.8 mm

RIC01781B
Fresino HB015
Cutter HB015
Fräser HB015
Fraise HB015
Fresa HB015



RIC01782B
Tastatore B015
Tracer Point B015
Taster B015
Palpeur B015
Palpador B015

303/304/305



**T-REX
T-REX ADVANCE**



STANDARD

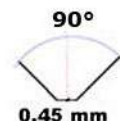

0.45 mm

RIC01793B
Fresino HB020
Cutter HB020
Fräser HB020
Fraise HB020
Fresa HB020



RIC01794B
Tastatore B020
Tracer Point B020
Taster B020
Palpeur B020
Palpador B020



PUNTO



MINI KABA

TO FIT: **KABA (CH)**



MINI KABA



NINJA TOTAL



NINJA VORTEX



VERSA

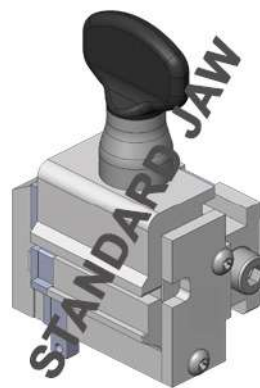
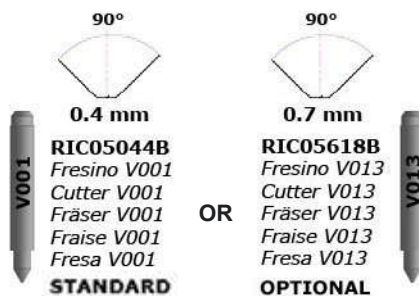

TO FIT: **KABA (CH)**

KABA GEMINI

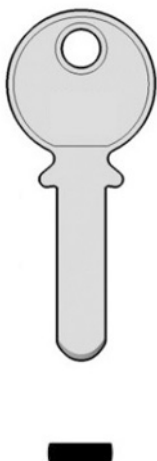

T-REX



303



PUNTO

OPTIONAL



MK15
Adattatori per chiavi Kaba 15°
Adaptors for Kaba 15° keys
Adapters für Kaba 15°-Schlüssel
Adaptateurs pour clés Kaba 15°
Adaptadores para llaves Kaba 15°

STANDARD

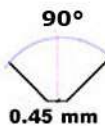

RIC01793B
Fresino HB020
Cutter HB020
Fräser HB020
Fraise HB020
Fresa HB020

RIC01794B
Tastatore B020
Tracer Point B020
Taster B020
Palpeur B020
Palpador B020

OPTIONAL

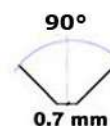

RIC01791B
Fresino HB001
Cutter HB001
Fräser HB001
Fraise HB001
Fresa HB001

RIC01792B
Tastatore B001
Tracer Point B001
Taster B001
Palpeur B001
Palpador B001

OPTIONAL



RIC01791B
Fresino HB001
Cutter HB001
Fräser HB001
Fraise HB001
Fresa HB001

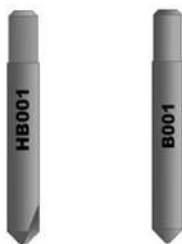

RIC01792B
Tastatore B001
Tracer Point B001
Taster B001
Palpeur B001
Palpador B001

STANDARD



RIC01793B
Fresino HB020
Cutter HB020
Fräser HB020
Fraise HB020
Fresa HB020



RIC01794B
Tastatore B020
Tracer Point B020
Taster B020
Palpeur B020
Palpador B020



T-REX ADVANCE



304/305

KABA GEMINI

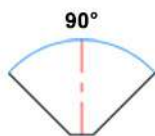

RIC05044B
Fresino V001
Cutter V001
Fräser V001
Fraise V001
Fresa V001



STANDARD

OPZ08505B
Morsetto C21
Jaw C21
Spannbacke C21
Étau C21
Mordaza C21

OPTIONAL

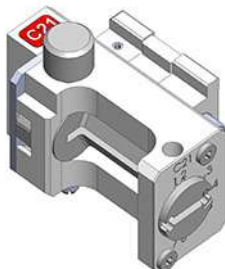

NINJA TOTAL



NINJA VORTEX



VERSA

maTrix

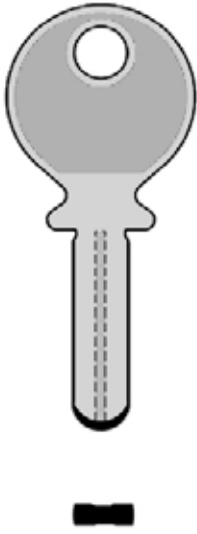

NINJA TOTAL



NINJA VORTEX



VERSA

OPTIONAL



0.56 mm

RIC06581B

Fresino V052
Cutter V052
Fräser V052
Fraise V052
Fresa V052



OPZ08505B

Morsetto C21
Jaw C21
Spannbacke C21
Étau C21
Mordaza C21

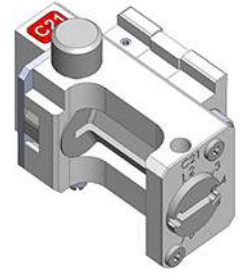

INCLUDED WITH JAW

Tastatore T005
Tracer Point T005
Taster T005
Palpeur T005
Palpador T005



304/305



**T-REX
T-REX ADVANCE**

OPTIONAL



0.7 mm

RIC01792B

Tastatore B001
Tracer Point B001
Taster B001
Palpeur B001
Palpador B001



RIC08487B

Fresino WB001
Cutter WB001
Fräser WB001
Fraise WB001
Fresa WB001

TO
FIT :

KAKEN (J)

OPTIONAL



OPZ07800B
Morsetto C15
Jaw C15
Spannbacke C15
Étau C15
Mordaza C15

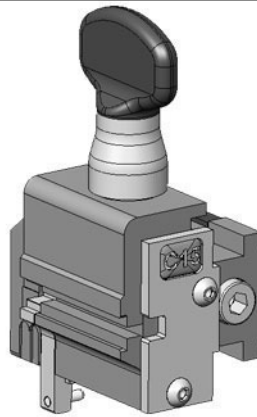

NINJA TOTAL



NINJA VORTEX



VERSA



TO
FIT :

KALE (TR)

STANDARD

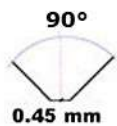

RIC01793B
Fresino HB020
Cutter HB020
Fräser HB020
Fraise HB020
Fresa HB020



RIC01794B
Tastatore B020
Tracer Point B020
Taster B020
Palpeur B020
Palpador B020



303/304/305



**T-REX
T-REX ADVANCE**



PUNTO



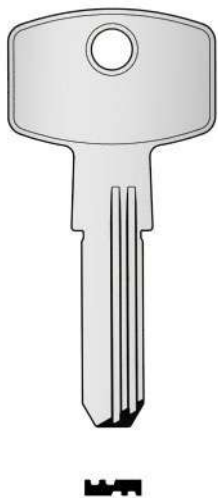

NINJA TOTAL



NINJA VORTEX



VERSA

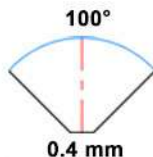

RIC05264B
 Fresino V007
 Cutter V007
 Fräser V007
 Fraise V007
 Fresa V007
OPTIONAL

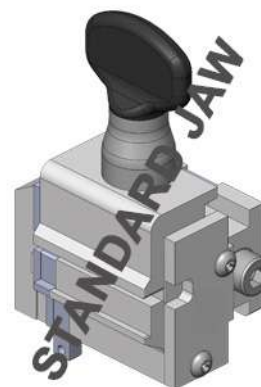

1000

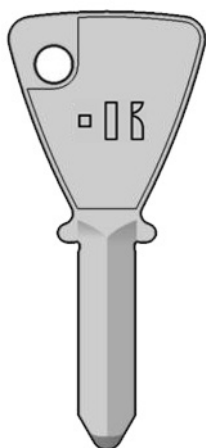

KS1



T-REX



303



PUNTO

OPTIONAL



MK5

Adattatori per chiavi Keso 5°
 Adaptors for Keso 5° keys
 Adapter für Keso 5°-Schlüssel
 Adaptateurs pour clés Keso 5°
 Adaptadores para llaves Keso 5°

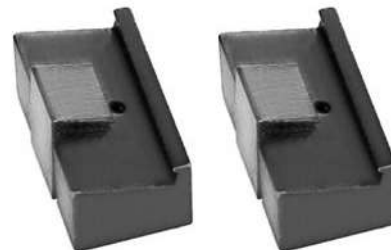

STANDARD



RIC01793B
 Fresino HB020
 Cutter HB020
 Fräser HB020
 Fraise HB020
 Fresa HB020

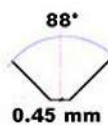

RIC01794B
 Tastatore B020
 Tracer Point B020
 Taster B020
 Palpeur B020
 Palpador B020

OPTIONAL



RIC01791B
 Fresino HB001
 Cutter HB001
 Fräser HB001
 Fraise HB001
 Fresa HB001

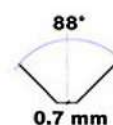

RIC01792B
 Tastatore B001
 Tracer Point B001
 Taster B001
 Palpeur B001
 Palpador B001

OPTIONAL



RIC01787B
 Fresino HB007
 Cutter HB007
 Fräser HB007
 Fraise HB007
 Fresa HB007



RIC01788B
 Tastatore B007
 Tracer Point B007
 Taster B007
 Palpeur B007
 Palpador B007

STANDARD



RIC01793B
Fresino HB020
Cutter HB020
Fräser HB020
Fraise HB020
Fresa HB020

RIC01794B
Tastatore B020
Tracer Point B020
Taster B020
Palpeur B020
Palpador B020

OPTIONAL

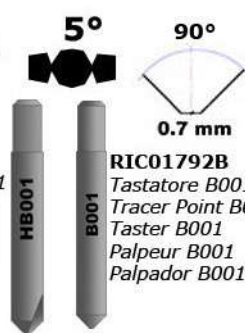

RIC01791B
Fresino HB001
Cutter HB001
Fräser HB001
Fraise HB001
Fresa HB001

RIC01792B
Tastatore B001
Tracer Point B001
Taster B001
Palpeur B001
Palpador B001

OPTIONAL

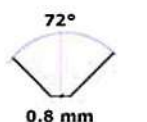

RIC01787B
Fresino HB007
Cutter HB007
Fräser HB007
Fraise HB007
Fresa HB007

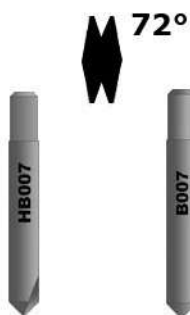

RIC01788B
Tastatore B007
Tracer Point B007
Taster B007
Palpeur B007
Palpador B007



T-REX ADVANCE
304/305

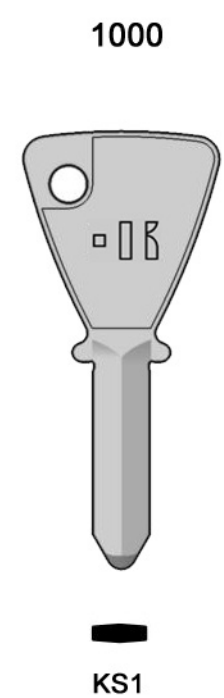

OPZ06711B
Morsetto C11
Jaw C11
Spannbacke C11
Étau C11
Mordaza C11
OPTIONAL

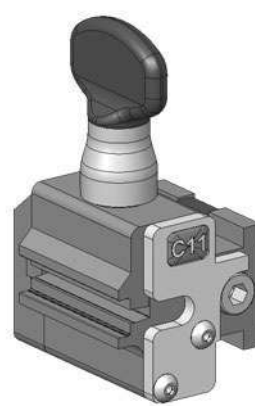

RIC05044B
Fresino V001
Cutter V001
Fräser V001
Fraise V001
Fresa V001
STANDARD



RIC05084B
Fresino V004
Cutter V004
Fräser V004
Fraise V004
Fresa V004
OPTIONAL



NINJA TOTAL
NINJA VORTEX
VERSA

2000

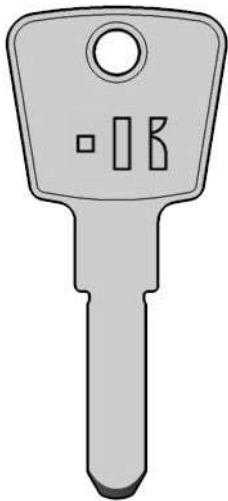

KS13



2500-4000-8000

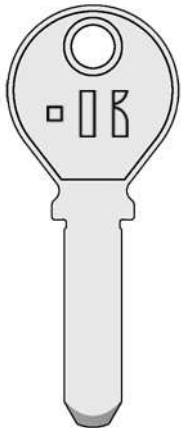

KS2

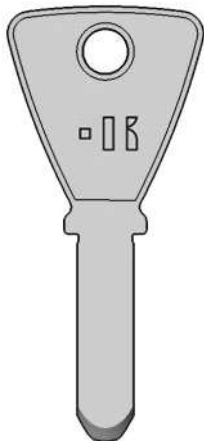

KS3



303/304/305

**T-REX
T-REX ADVANCE**

PUNTO

OPTIONAL

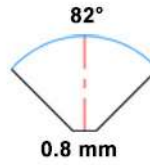

RIC01783B
Fresino HB026
Cutter HB026
Fräser HB026
Fraise HB026
Fresa HB026



RIC01784B
Tastatore B026
Tracer Point B026
Taster B026
Palpeur B026
Palpador B026



NINJA TOTAL

NINJA VORTEX



VERSA

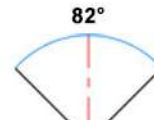

0.5 mm
RIC05084B
Fresino V004
Cutter V004
Fräser V004
Fraise V004
Fresa V004
OPTIONAL

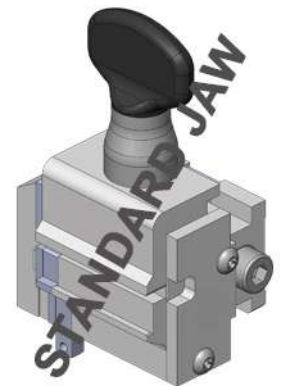

OPTIONAL

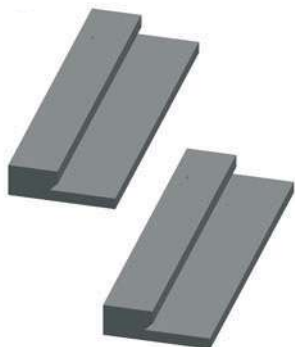

OPZ06644B
Adattatori per Kaba Micro e KYR
Adaptors for Kaba Micro and KYR
Adaptors für Kaba Micro und KYR
Adaptateurs pour Kaba Micro et KYR
Adaptadores para Kaba Micro y KYR



303/304/305



**T-REX
T-REX ADVANCE**



KYR1

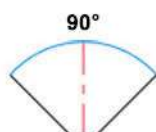

0.4 mm



RIC05044B
Fresino V001
Cutter V001
Fräser V001
Fraise V001
Fresa V001
STANDARD

OPZ07800B
Morsetto C15
Jaw C15
Spannbacke C15
Étau C15
Mordaza C15
OPTIONAL



NINJA TOTAL



NINJA VORTEX



VERSA

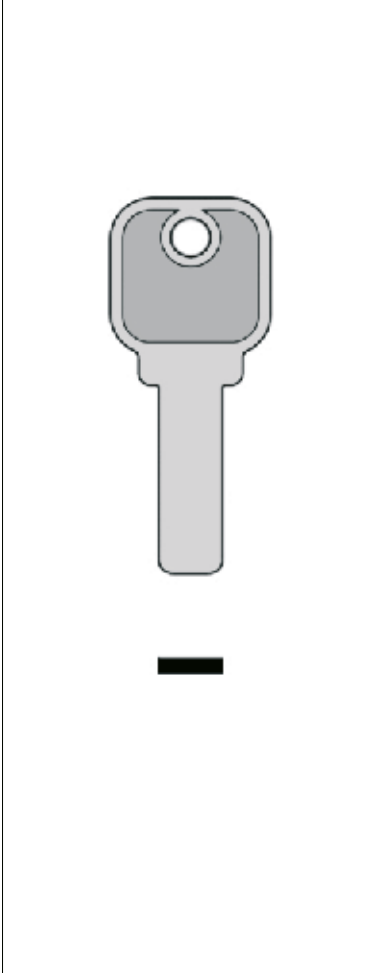

STANDARD

90°

0.45 mm

RIC01793B
Fresino HB020
Cutter HB020
Fräser HB020
Fraise HB020
Fresa HB020

RIC01794B
Tastatore B020
Tracer Point B020
Taster B020
Palpeur B020
Palpador B020



OPTIONAL

3,0 mm

RIC01715B
Fresino HC030
Cutter HC030
Fräser HC030
Fraise HC030
Fresa HC030

RIC01716B
Tastatore C030
Tracer Point C030
Taster C030
Palpeur C030
Palpador C030

STANDARD

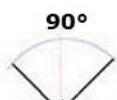

0.45 mm

RIC01793B
Fresino HB020
Cutter HB020
Fräser HB020
Fraise HB020
Fresa HB020



RIC01794B
Tastatore B020
Tracer Point B020
Taster B020
Palpeur B020
Palpador B020



303/304/305



**T-REX
T-REX ADVANCE**



PUNTO

XA/XB/XC
XD/XE

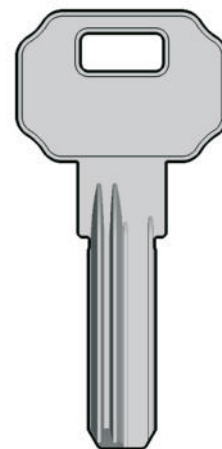

4.0 mm

RIC05044B
Fresino V001
Cutter V001
Fräser V001
Fraise V001
Fresa V001
STANDARD



OPZ05701B
Morsetto C03
Jaw C03
Spannbacke C03
Étau C03
Mordaza C03
OPTIONAL



NINJA TOTAL



NINJA VORTEX



VERSA

2000

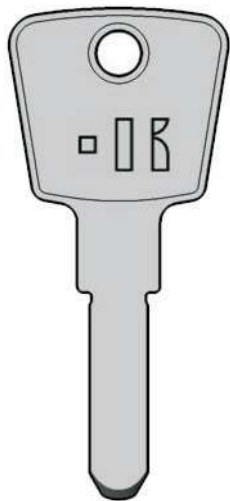

KS13



303/304/305



**T-REX
T-REX ADVANCE**



PUNTO

STANDARD

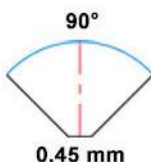

RIC01793B
Fresino HB020
Cutter HB020
Fräser HB020
Fraise HB020
Fresa HB020



RIC01794B
Tastatore B020
Tracer Point B020
Taster B020
Palpeur B020
Palpador B020

OPTIONAL

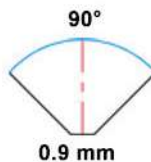

RIC01775B
Fresino HB005
Cutter HB005
Fräser HB005
Fraise HB005
Fresa HB005

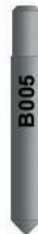

RIC01776B
Tastatore B005
Tracer Point B005
Taster B005
Palpeur B005
Palpador B005

OPTIONAL

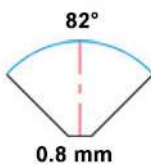

RIC01783B
Fresino HB026
Cutter HB026
Fräser HB026
Fraise HB026
Fresa HB026



RIC01784B
Tastatore B026
Tracer Point B026
Taster B026
Palpeur B026
Palpador B026



NINJA TOTAL



NINJA VORTEX



VERSA

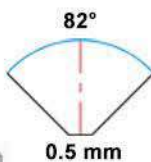

RIC05084B
Fresino V004
Cutter V004
Fräser V004
Fraise V004
Fresa V004
OPTIONAL

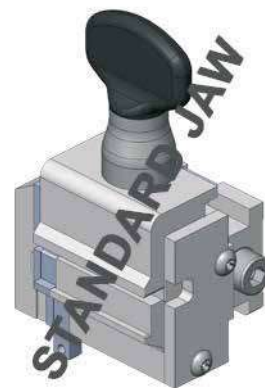

OPTIONAL

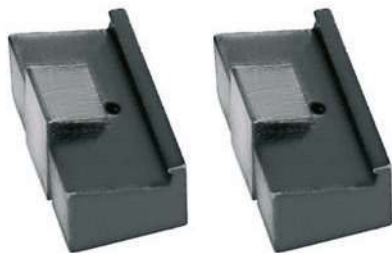

MK5

Adattatori per chiavi Keso 5°
Adaptors for Keso 5° keys
Adapters für Keso 5°-Schlüssel
Adaptateurs pour clés Keso 5°
Adaptadores para llaves Keso 5°



T-REX

STANDARD



RIC01793B
Fresino HB020
Cutter HB020
Fräser HB020
Fraise HB020
Fresa HB020

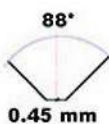

RIC01794B
Tastatore B020
Tracer Point B020
Taster B020
Palpeur B020
Palpador B020



RIC01791B
Fresino HB001
Cutter HB001
Fräser HB001
Fraise HB001
Fresa HB001

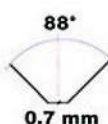

RIC01792B
Tastatore B001
Tracer Point B001
Taster B001
Palpeur B001
Palpador B001



303



PUNTO



L111

OPTIONAL



RIC01787B
Fresino HB007
Cutter HB007
Fräser HB007
Fraise HB007
Fresa HB007



RIC01788B
Tastatore B007
Tracer Point B007
Taster B007
Palpeur B007
Palpador B007

STANDARD



RIC01793B
Fresino HB020
Cutter HB020
Fräser HB020
Fraise HB020
Fresa HB020

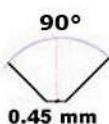

RIC01794B
Tastatore B020
Tracer Point B020
Taster B020
Palpeur B020
Palpador B020



RIC01791B
Fresino HB001
Cutter HB001
Fräser HB001
Fraise HB001
Fresa HB001

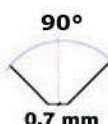

RIC01792B
Tastatore B001
Tracer Point B001
Taster B001
Palpeur B001
Palpador B001



T-REX ADVANCE



304/305

OPTIONAL



RIC01787B
Fresino HB007
Cutter HB007
Fräser HB007
Fraise HB007
Fresa HB007



RIC01788B
Tastatore B007
Tracer Point B007
Taster B007
Palpeur B007
Palpador B007

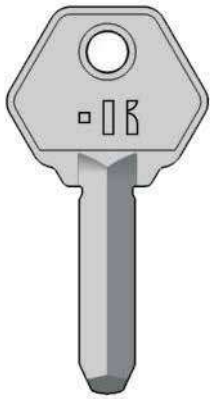

L111



NINJA TOTAL



NINJA VORTEX



VERSA



OPZ06711B
Morsetto C11
Jaw C11
Spannbacke C11
Étau C11
Mordaza C11
OPTIONAL

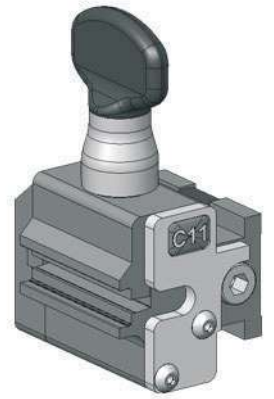

TO
FIT :

LUMA (E)

OPTIONAL

OPZ06731B
Morsetto 12
Jaw 12
Spannbacke 12
Étau 12
Mordaza 12

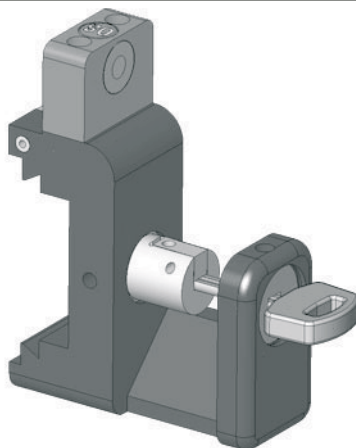

**POWER LYNX
SIGMA PRO**



ABU12P

PLUS

TO
FIT :

M&C (NL)

OPTIONAL

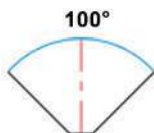

0.4 mm

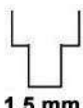

1.5 mm



RIC05264B
Fresino V007
Cutter V007
Fräser V007
Fraise V007
Fresa V007

FOR EDGE CUT



RIC05274B
Fresino V012
Cutter V012
Fräser V012
Fraise V012
Fresa V012

FOR LASER CUT

OPZ10611B
Morsetto C43
Jaw C43
Spannbacke C43
Étau C43
Mordaza C43



NINJA VORTEX



VERSA

MATRIX

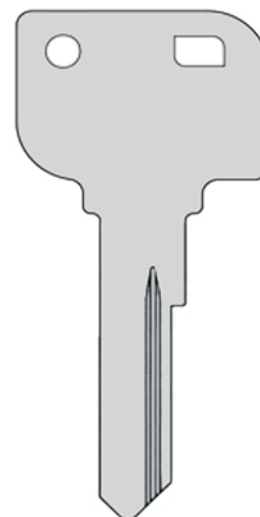

OPTIONAL

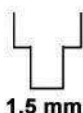

1.5 mm



RIC05274B
Fresino V012
Cutter V012
Fräser V012
Fraise V012
Fresa V012

FOR LASER CUT

OPZ10611B
Morsetto C43
Jaw C43
Spannbacke C43
Étau C43
Mordaza C43



NINJA TOTAL



CONDOR

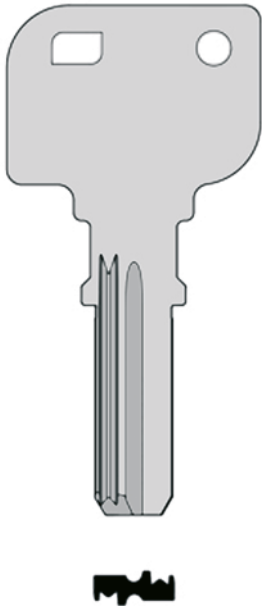

NINJA TOTAL



NINJA VORTEX



VERSA

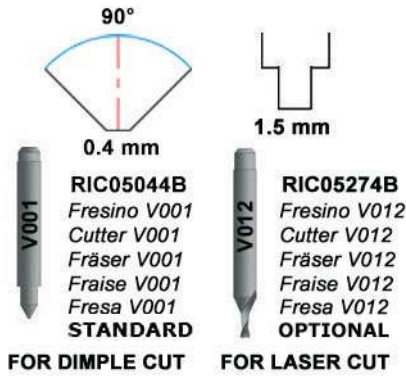

OPZ10611B
Morsetto C43
Jaw C43
Spannbacke C43
Étau C43
Mordaza C43
OPTIONAL

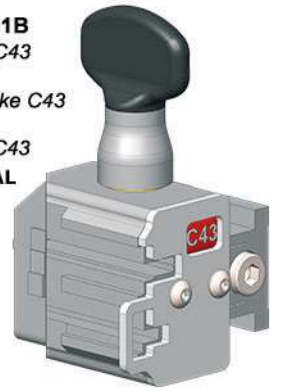

MAGNUM / ONGUARD MILLECO

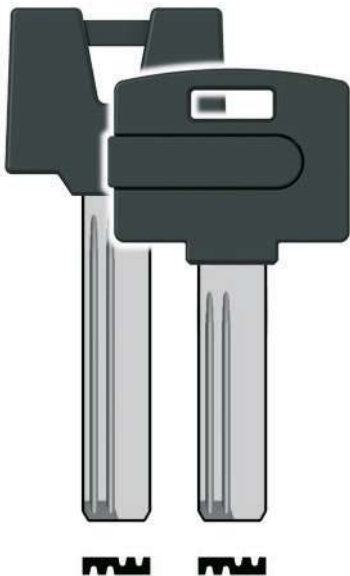

NINJA TOTAL



NINJA VORTEX



VERSA

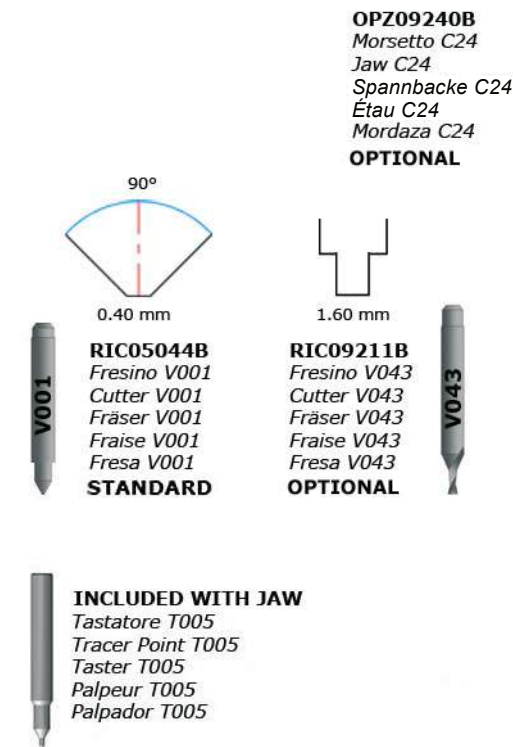

OPZ09240B
Morsetto C24
Jaw C24
Spannbacke C24
Étau C24
Mordaza C24
OPTIONAL



TO
FIT :

MAGNUM (CH/UK)

STANDARD

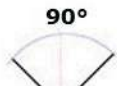

0.45 mm

RIC01793B
Fresino HB020
Cutter HB020
Fräser HB020
Fraise HB020
Fresa HB020



RIC01794B
Tastatore B020
Tracer Point B020
Taster B020
Palpeur B020
Palpador B020



T-REX ADVANCE



304/305

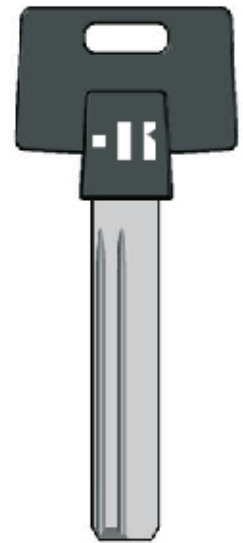

MGN1SP

OPTIONAL



1,3 mm

RIC08491B
Fresino HC130
Cutter HC130
Fräser HC130
Fraise HC130
Fresa HC130



RIC08492B
Tastatore C130
Tracer Point C130
Taster C130
Palpeur C130
Palpador C130

TO
FIT :

MAUER (BG)

STANDARD

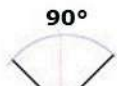

0.45 mm

RIC01793B
Fresino HB020
Cutter HB020
Fräser HB020
Fraise HB020
Fresa HB020



RIC01794B
Tastatore B020
Tracer Point B020
Taster B020
Palpeur B020
Palpador B020



303/304/305



**T-REX
T-REX ADVANCE**



PUNTO

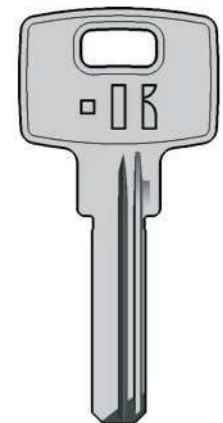

MA1S

NW4

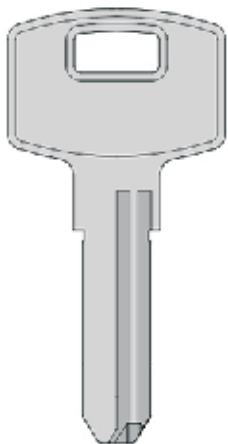

NINJA TOTAL



NINJA VORTEX



VERSA

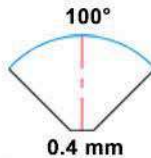

RIC05264B
 Fresino V007
 Cutter V007
 Fräser V007
 Fraise V007
 Fresa V007
 OPTIONAL

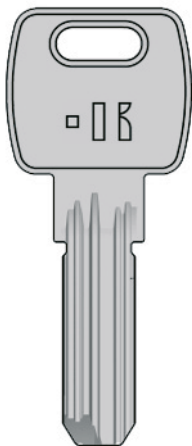
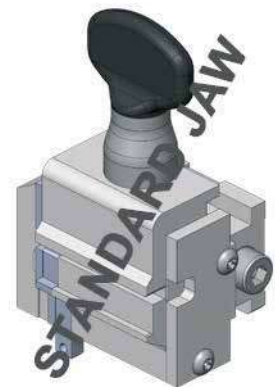

MC15S



303/304/305



T-REX
 T-REX ADVANCE



PUNTO

STANDARD

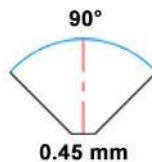

0.45 mm

RIC01793B
 Fresino HB020
 Cutter HB020
 Fräser HB020
 Fraise HB020
 Fresa HB020



RIC01794B
 Tastatore B020
 Tracer Point B020
 Taster B020
 Palpeur B020
 Palpador B020

OPTIONAL

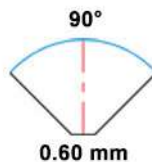

0.60 mm

RIC01785B
 Fresino HB039
 Cutter HB039
 Fräser HB039
 Fraise HB039
 Fresa HB039



RIC01786B
 Tastatore B039
 Tracer Point B039
 Taster B039
 Palpeur B039
 Palpador B039

TO
FIT :

MCM (E)

OPTIONAL

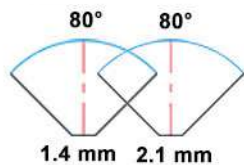

RIC03964B
Fresino HB037
Cutter HB037
Fräser HB037
Fraise HB037
Fresa HB037



RIC03965B
Tastatore B037
Tracer Point B037
Taster B037
Palpeur B037
Palpador B037

RIC03970B
Fresino HB038
Cutter HB038
Fräser HB038
Fraise HB038
Fresa HB038

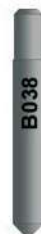

RIC03971B
Tastatore B038
Tracer Point B038
Taster B038
Palpeur B038
Palpador B038

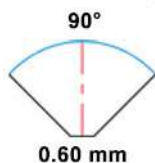
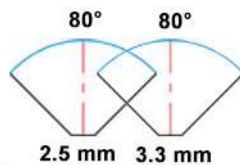

RIC01785B
Fresino HB039
Cutter HB039
Fräser HB039
Fraise HB039
Fresa HB039



RIC01786B
Tastatore B039
Tracer Point B039
Taster B039
Palpeur B039
Palpador B039



303/304/305



T-REX
T-REX ADVANCE



PUNTO

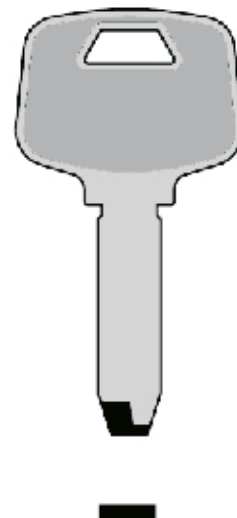

TO
FIT :

MCM (E)

OPTIONAL

MCM

Adattatori per chiavi MCM
Adaptors for MCM keys
Adapters für MCM-Schlüssel
Adaptateurs pour clés MCM
Adaptadores para llaves MCM

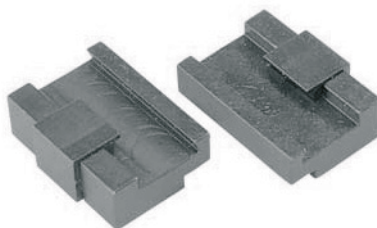

303/304/305



T-REX
T-REX ADVANCE



PUNTO

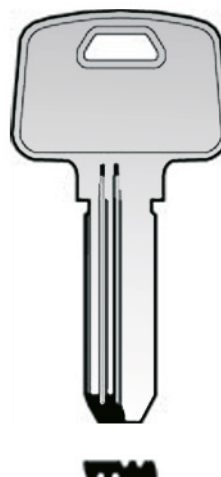

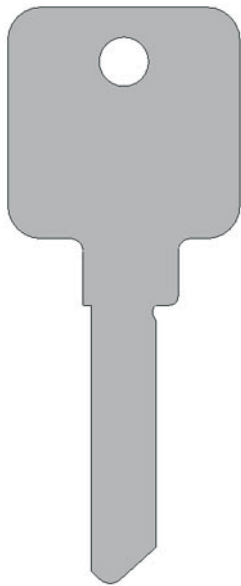

NINJA TOTAL



NINJA VORTEX



VERSA

OPTIONAL



0.87 mm
RIC07785B
 Fresino V036
 Cutter V036
 Fräser V036
 Fraise V036
 Fresa V036

OPZ08204B
 Morsetto C09
 Jaw C09
 Spannbacke C09
 Étau C09
 Mordaza C09

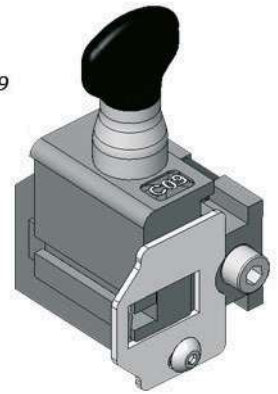

ME39



303/304/305



**T-REX
T-REX ADVANCE**



PUNTO

OPTIONAL



2.0 mm

RIC01816B
 Fresino HC044
 Cutter HC044
 Fräser HC044
 Fraise HC044
 Fresa HC044



RIC01817B
 Tastatore C044
 Tracer Point C044
 Taster C044
 Palpeur C044
 Palpador C044

OPZ10306B*
 Adattatore AV10 per chiavi Meroni
 Adaptor AV10 for Meroni keys
 Adapter AV10 für Meroni-Schlüssel
 Adaptateur AV10 pour clés Meroni
 Adaptador AV10 para llaves Meroni



*Per Tagliare la chiave è necessario ordinare 2 adattatori
 *To cut the key it is necessary to order 2 adaptors
 *Um die Schlüssel zu schneiden es nöting 2 Adapter zu bestellen
 *Pour tailler la clé, il faut commander 2 adaptateurs
 *Para cortar la llave es necesario pedir 2 adaptadores

TO
FIT :

MERONI (I)



2.5 mm



RIC05048B
Fresino V003
Cutter V003
Fräser V003
Fraise V003
Fresa V003
STANDARD

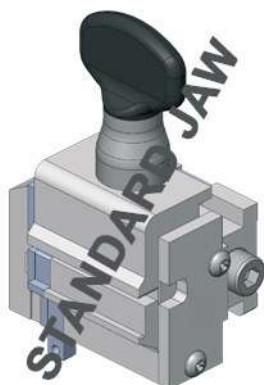

OPZ10306B

Adattatore AV10 per chiavi Meroni
Adaptor AV10 for Meroni keys
Adapter AV10 für Meroni-Schlüssel
Adaptateur AV10 pour clés Meroni
Adaptador AV10 para llaves Meroni

OPTIONAL



NINJA TOTAL



NINJA VORTEX



VERSA



ME39

TO
FIT :

MG MONTI (I)

STANDARD



90°

0.45 mm

RIC01793B
Fresino HB020
Cutter HB020
Fräser HB020
Fraise HB020
Fresa HB020



RIC01794B
Tastatore B020
Tracer Point B020
Taster B020
Palpeur B020
Palpador B020



303/304/305



**T-REX
T-REX ADVANCE**



PUNTO

X8

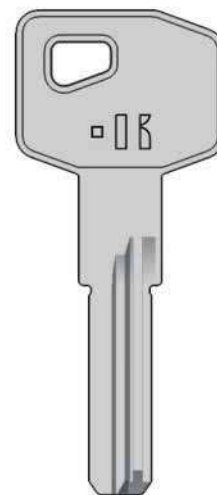

MN2S



TO FIT: **MG MONTI (I)**

X8



JPT
MN2S



NINJA TOTAL



NINJA VORTEX



VERSA

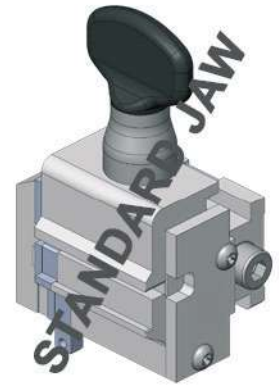
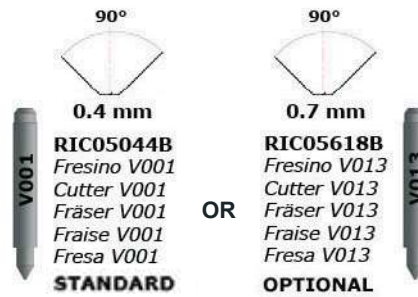

TO FIT: **MG MONTI (I)**

HS

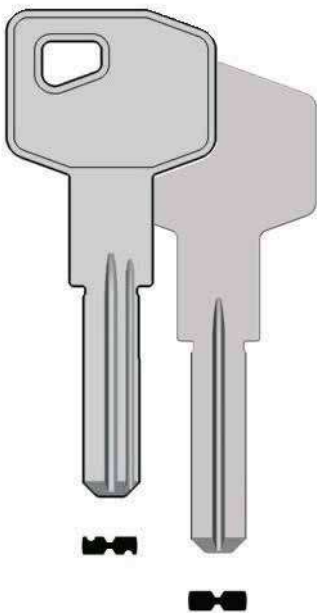

303/304/305



**T-REX
T-REX ADVANCE**



PUNTO

STANDARD

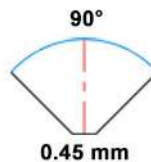

RIC01793B
Fresino HB020
Cutter HB020
Fräser HB020
Fraise HB020
Fresa HB020

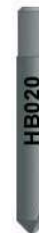

RIC01794B
Tastatore B020
Tracer Point B020
Taster B020
Palpeur B020
Palpador B020

OPTIONAL

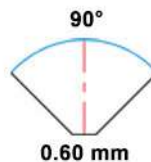

RIC01785B
Fresino HB039
Cutter HB039
Fräser HB039
Fraise HB039
Fresa HB039



RIC01786B
Tastatore B039
Tracer Point B039
Taster B039
Palpeur B039
Palpador B039

TO
FIT :

MG MONTI (I)



OR

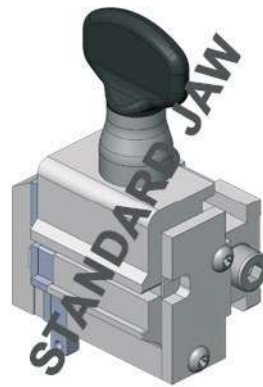

NINJA TOTAL



NINJA VORTEX



VERSA

HS

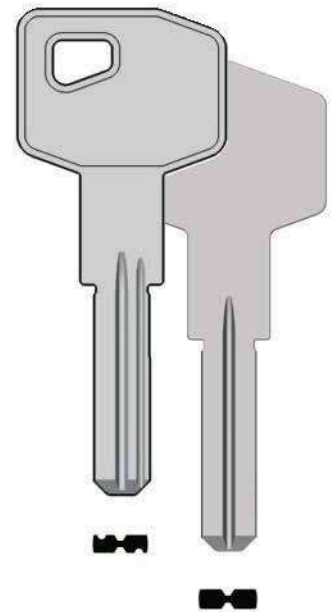

TO
FIT :

MG MONTI (I)



OPZ05703B
Morsetto C04
Jaw C04
Spannbacke C04
Étau C04
Mordaza C04
OPTIONAL

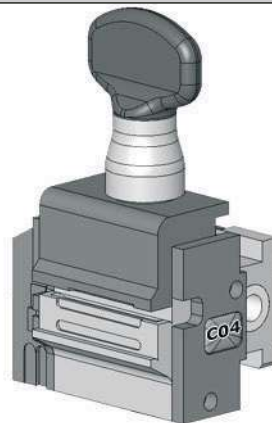

NINJA TOTAL



NINJA VORTEX



VERSA

HSP

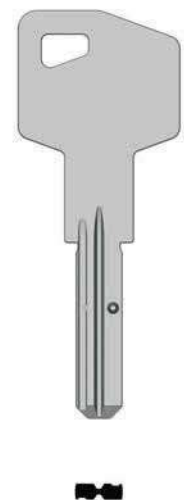

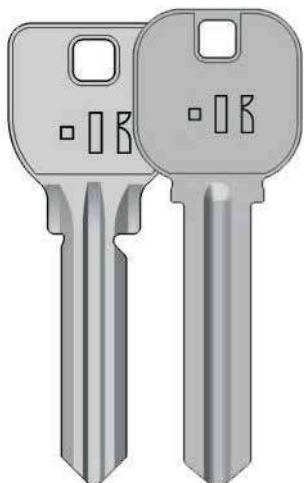

KL760

KL248



DEZMO

OPTIONAL

OPZ08441B
Morsetto Z20 per chiavi giapponesi
Jaw Z20 for japanese keys
Spannbacke Z20 für Japanisch-Schlüssel
Étau Z20 pour clés japonaises
Mordaza para llaves japonesas

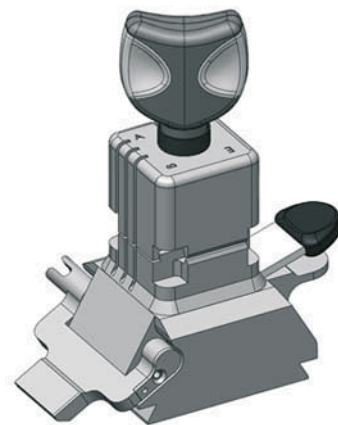

CARAT/106

OPTIONAL



RIC08326B
Morsetto 4 facce per chiavi giapponesi
Jaw 4 sides for japanese keys
Spannbacke 4 seiten für Japanisch-Schlüssel
Étau 4 faces pour clés japonaises
Mordaza 4 lados para llaves japonesas



NINJA LASER



NINJA TOTAL



**NINJA
NINJA DARK**

OPTIONAL

OPZ09126B
Morsetto N20 per chiavi Miwa
Jaw N20 for Miwa keys
Spannbacke N20 für Miwa-Schlüssel
Étau N20 pour clés Miwa
Mordaza N20 para llaves Miwa

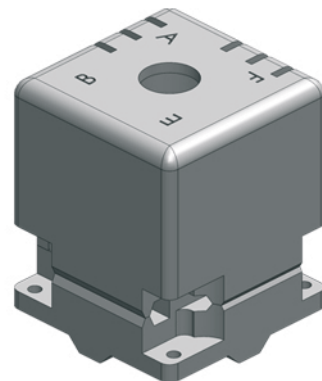

STANDARD

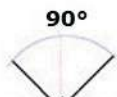

0.45 mm

RIC01793B
Fresino HB020
Cutter HB020
Fräser HB020
Fraise HB020
Fresa HB020



RIC01794B
Tastatore B020
Tracer Point B020
Taster B020
Palpeur B020
Palpador B020



303/304/305



**T-REX
T-REX ADVANCE**



PUNTO

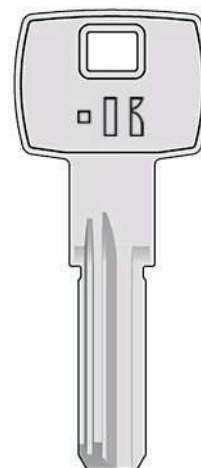

MRI1

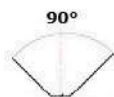

0.4 mm

RIC05044B
Fresino V001
Cutter V001
Fräser V001
Fraise V001
Fresa V001
STANDARD



OR

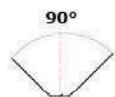

0.7 mm

RIC05618B
Fresino V013
Cutter V013
Fräser V013
Fraise V013
Fresa V013
OPTIONAL

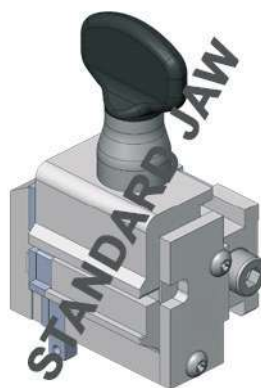

NINJA TOTAL



NINJA VORTEX



VERSA

DEFENDER

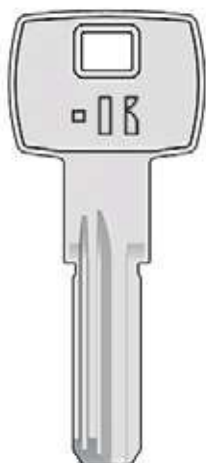

MRI1



303/304/305



**T-REX
T-REX ADVANCE**



PUNTO



NINJA TOTAL



NINJA VORTEX



VERSA

OPTIONAL

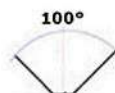

0.7 mm

RIC01789B
*Fresino HB042
 Cutter HB042
 Fräser HB042
 Fraise HB042
 Fresa HB042*



RIC01790B
*Tastatore B042
 Tracer Point B042
 Taster B042
 Palpeur B042
 Palpador B042*

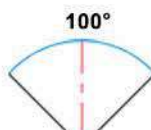

0.4 mm

RIC05264B
*Fresino V007
 Cutter V007
 Fräser V007
 Fraise V007
 Fresa V007*



OPTIONAL

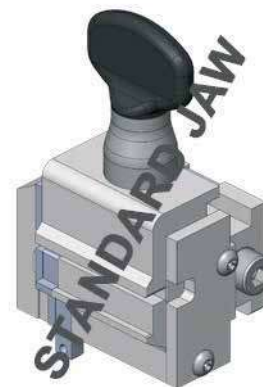

OPTIONAL

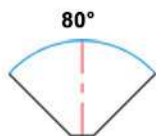

0.70 mm

RIC03964B

*Fresino HB037
Cutter HB037
Fräser HB037
Fraise HB037
Fresa HB037*



RIC01786B

*Tastatore B037
Tracer Point B037
Taster B037
Palpeur B037
Palpador B037*



303/304/305



**T-REX
T-REX ADVANCE**



PUNTO

CHAMPIONS

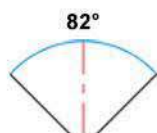

0.5 mm

RIC05084B

*Fresino V004
Cutter V004
Fräser V004
Fraise V004
Fresa V004
OPTIONAL*

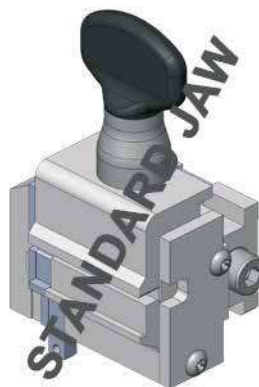

NINJA TOTAL



NINJA VORTEX



VERSA

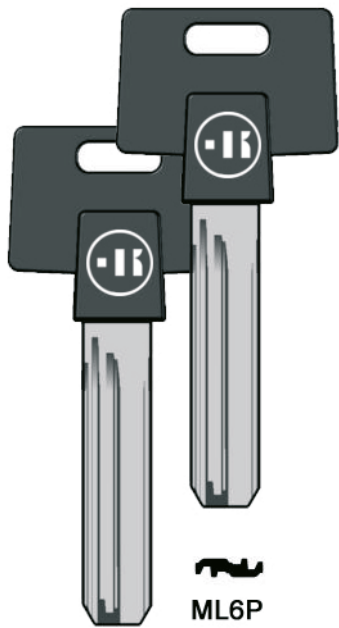

ML4P



OPTIONAL

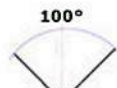

**0.3 mm
RIC01777B**
Fresino HB012A
Cutter HB012A
Fräser HB012A
Fraise HB012A
Fresa HB012A



RIC01778B
Tastatore B012A
Tracer Point B012A
Taster B012A
Palpeur B012A
Palpador B012A

OPTIONAL



**0.3 mm 0.3 mm
RIC01779B**
Fresino HB012B
Cutter HB012B
Fräser HB012B
Fraise HB012B
Fresa HB012B



RIC01780B
Tastatore B012B
Tracer Point B012B
Taster B012B
Palpeur B012B
Palpador B012B

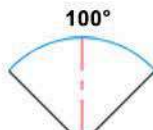

0.4 mm



RIC05264B
Fresino V007
Cutter V007
Fräser V007
Fraise V007
Fresa V007
OPTIONAL

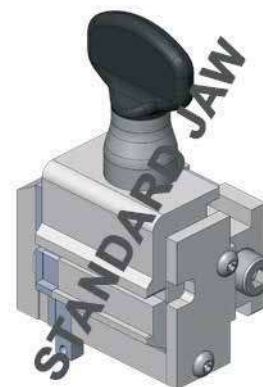

TO
FIT :

MUL.T.LOCK (IL)

OPTIONAL

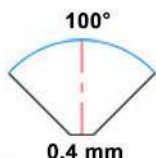

RIC05264B
Fresino V007
Cutter V007
Fräser V007
Fraise V007
Fresa V007

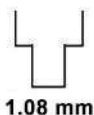

RIC07782B
Fresino V035
Cutter V035
Fräser V035
Fraise V035
Fresa V035



OPZ07800B
Morsetto C15
Jaw C15
Spannbacke C15
Étau C15
Mordaza C15



NINJA TOTAL



NINJA VORTEX



VERSA

MT5
MT5+



TO
FIT :

MUL.T.LOCK (IL)

OPTIONAL

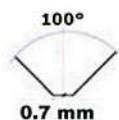

RIC01789B
Fresino HB042
Cutter HB042
Fräser HB042
Fraise HB042
Fresa HB042



RIC01790B
Tastatore B042
Tracer Point B042
Taster B042
Palpeur B042
Palpador B042



303/304/305



**T-REX
T-REX ADVANCE**



PUNTO



ML13P



T-REX ADVANCE

304/305

OPTIONAL

RIC08488B
Fresino WB019
Cutter WB019
Fräser WB019
Fraise WB019
Fresa WB019



RIC08489B
Tastatore B019
Tracer Point B019
Taster B019
Palpeur B019
Palpador B019



NINJA TOTAL



NINJA VORTEX



VERSA

OPTIONAL

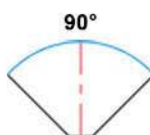

0.8 mm



RIC06368B
Fresino V022
Cutter V022
Fräser V022
Fraise V022
Fresa V022



INCLUDED WITH JAW
Tastatore T005
Tracer Point T005
Taster T005
Palpeur T005
Palpador T005

OPZ08506B
Morsetto C22
Jaw C22
Spannbacke C22
Étau C22
Mordaza C22

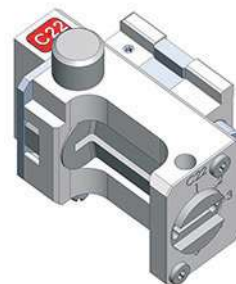

STANDARD

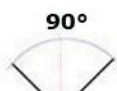

0.45 mm

RIC01793B
Fresino HB020
Cutter HB020
Fräser HB020
Fraise HB020
Fresa HB020



RIC01794B
Tastatore B020
Tracer Point B020
Taster B020
Palpeur B020
Palpador B020



303/304/305



**T-REX
T-REX ADVANCE**



PUNTO



OMC13



0.4 mm

RIC05044B
Fresino V001
Cutter V001
Fräser V001
Fraise V001
Fresa V001
STANDARD

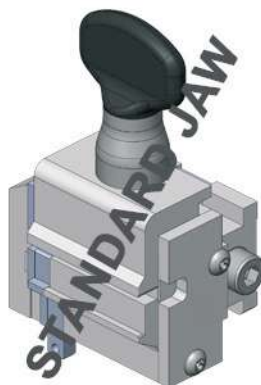

OR

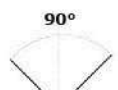

0.7 mm

RIC05618B
Fresino V013
Cutter V013
Fräser V013
Fraise V013
Fresa V013
OPTIONAL



OR



0.5 mm

RIC05084B
Fresino V004
Cutter V004
Fräser V004
Fraise V004
Fresa V004
OPTIONAL



NINJA TOTAL



NINJA VORTEX



VERSA



OMC14



303/304/305



**T-REX
T-REX ADVANCE**



PUNTO



NINJA TOTAL



NINJA VORTEX



VERSA

OPTIONAL

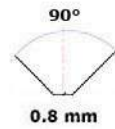

0.8 mm

RIC01783B
*Fresino HB026
Cutter HB026
Fräser HB026
Fraise HB026
Fresa HB026*



RIC01784B
*Tastatore B026
Tracer Point B026
Taster B026
Palpeur B026
Palpador B026*



0.5 mm

RIC05084B
*Fresino V004
Cutter V004
Fräser V004
Fraise V004
Fresa V004*
OPTIONAL



OPTIONAL

OPZ08431B

Morsetto Z19 per chiavi Pfaffenhain
Jaw Z19 for Pfaffenhain keys
Spannbacke Z19 für Pfaffenhain Schlüssel
Étau Z19 pour clés Pfaffenhain
Mordaza Z19 para llaves Pfaffenhain

FOR EDGE CUT



DEZMO

INTEGRAL

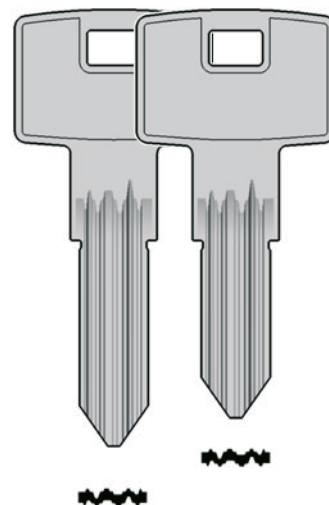

NINJA TOTAL



NINJA VORTEX



VERSA



0.4 mm

RIC05044B
Fresino V001
Cutter V001
Fräser V001
Fraise V001
Fresa V001
STANDARD

OR

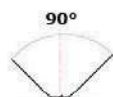

0.7 mm

RIC05618B
Fresino V013
Cutter V013
Fräser V013
Fraise V013
Fresa V013
OPTIONAL

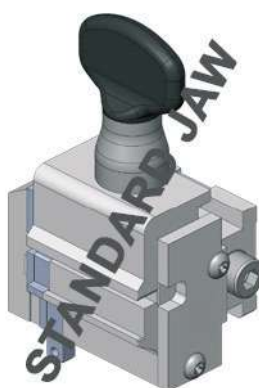

OPTIONAL

OPZ09531B

Morsetto N25
Jaw N25
Spannbacke N25
Étau N25
Mordaza N25

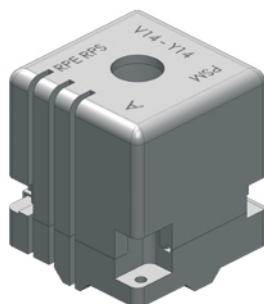

NINJA LASER



**NINJA
NINJA DARK**

TO FIT: PFAFFENHAIN (D)

K14 KV14

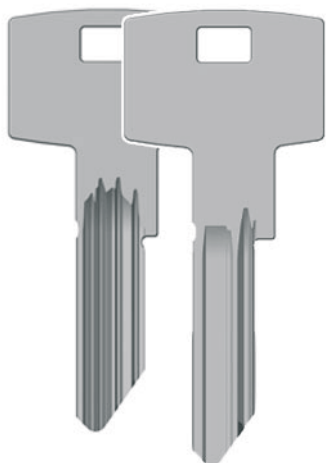

VERSA

OPZ05807B

Morsetto C07 con adattatori Pfaffenhein
 Jaw C07 with Pfaffenhein adaptors
 Spannbacke C07 mit Pfaffenhein Adapters
 Étau C07 avec adaptateurs Pfaffenhein
 Mordaza C07 con adaptadores Pfaffenhein

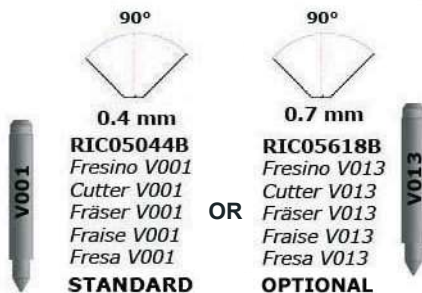

0.4 mm
RIC05044B
 Fresino V001
 Cutter V001
 Fräser V001
 Fraise V001
 Fresa V001

0.7 mm
RIC05618B
 Fresino V013
 Cutter V013
 Fräser V013
 Fraise V013
 Fresa V013

STANDARD

OPTIONAL

FOR DIMPLE CUT

OPTIONAL

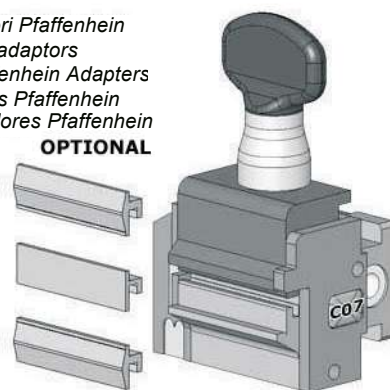

NINJA LASER



NINJA NINJA DARK

OPTIONAL

OPZ09531B

Morsetto N25
 Jaw N25
 Spannbacke N25
 Étau N25
 Mordaza N25

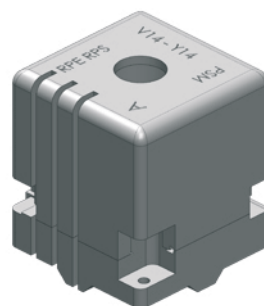

TO FIT: PFAFFENHAIN (D)

WAVYLINE

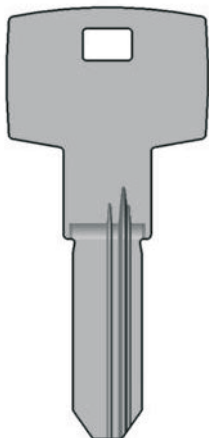

DEZMO

OPTIONAL

OPZ08431B

Morsetto Z19 per chiavi Pfaffenhein
 Jaw Z19 for Pfaffenhein keys
 Spannbacke Z19 für Pfaffenhein Schlüssel
 Étau Z19 pour clés Pfaffenhein
 Mordaza Z19 para llaves Pfaffenhein

FOR EDGE CUT



TO
FIT :

PFAFFENHAIN (D)

OPTIONAL

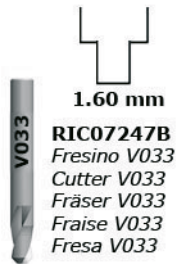

OPZ07237B
Morsetto C13
Jaw C13
Spannbacke C13
Étau C13
Mordaza C13

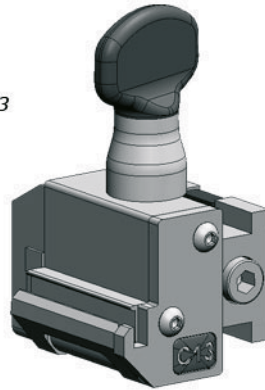

VERSA

WAVYLINE

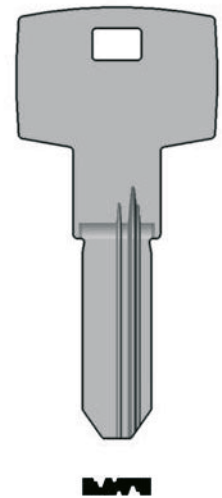

OPTIONAL

OPZ09531B
Morsetto N25
Jaw N25
Spannbacke N25
Étau N25
Mordaza N25

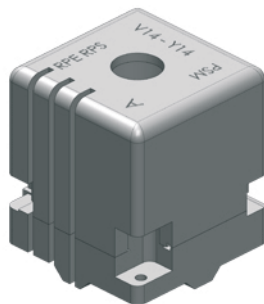

NINJA LASER

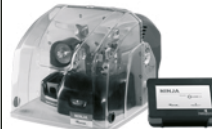

**NINJA
NINJA DARK**

TO
FIT :

PFAFFENHAIN (D)

OPTIONAL

OPZ08431B
Morsetto Z19 per chiavi Pfaffenhain
Jaw Z19 for Pfaffenhain keys
Spannbacke Z19 für Pfaffenhain Schlüssel
Étau Z19 pour clés Pfaffenhain
Mordaza Z19 para llaves Pfaffenhain

FOR EDGE CUT



DEZMO

V14



V14



NINJA LASER



NINJA TOTAL



NINJA NINJA DARK



NINJA VORTEX



VERSA

OPTIONAL

OPZ09531B
 Morsetto N25
 Jaw N25
 Spannbacke N25
 Étau N25
 Mordaza N25

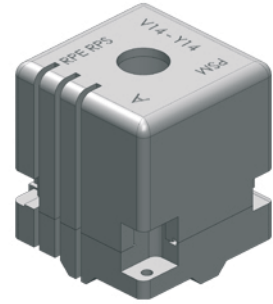

OPTIONAL

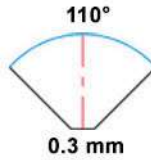

RIC05270B
 Fresino V010
 Cutter V010
 Fräser V010
 Fraise V010
 Fresa V010

OPZ06039B
 Morsetto C08
 Jaw C08
 Spannbacke C08
 Étau C08
 Mordaza C08



OPTIONAL

OPZ08431B

Morsetto Z19 per chiavi Pfaffenhain
Jaw Z19 for Pfaffenhain keys
Spannbacke Z19 für Pfaffenhain Schlüssel
Étau Z19 pour clés Pfaffenhain
Mordaza Z19 para llaves Pfaffenhain

FOR EDGE CUT



DEZMO

Y14



OPTIONAL

OPZ09531B

Morsetto N25
Jaw N25
Spannbacke N25
Étau N25
Mordaza N25

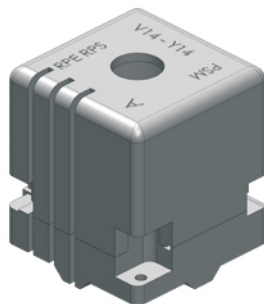

NINJA LASER



NINJA TOTAL



**NINJA
NINJA DARK**

**Prof
V+XV**



DEZMO

OPTIONAL

OPZ08431B

Morsetto Z19 per chiavi Pfaffenhain

Jaw Z19 for Pfaffenhain keys

Spannbacke Z19 für Pfaffenhain Schlüssel

Étau Z19 pour clés Pfaffenhain

Mordaza Z19 para llaves Pfaffenhain



FOR EDGE CUT



NINJA LASER

OPTIONAL



NINJA TOTAL



**NINJA
NINJA DARK**

OPZ09531B

Morsetto N25

Jaw N25

Spannbacke N25

Étau N25

Mordaza N25

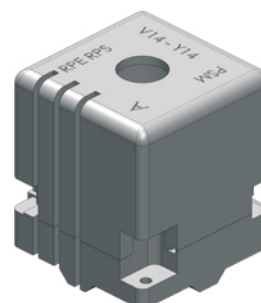

TO
FIT :

PICARDIE (F)

OPTIONAL

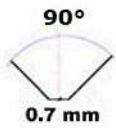

RIC01791B
Fresino HB001
Cutter HB001
Fräser HB001
Fraise HB001
Fresa HB001



RIC01792B
Tastatore B001
Tracer Point B001
Taster B001
Palpeur B001
Palpador B001

303/304/305



**T-REX
T-REX ADVANCE**



STANDARD

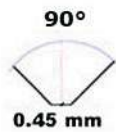

RIC01793B
Fresino HB020
Cutter HB020
Fräser HB020
Fraise HB020
Fresa HB020



RIC01794B
Tastatore B020
Tracer Point B020
Taster B020
Palpeur B020
Palpador B020



PUNTO

TO
FIT :

POTENT (I)

OPTIONAL

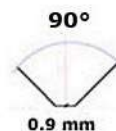

RIC01775B
Fresino HB005
Cutter HB005
Fräser HB005
Fraise HB005
Fresa HB005



RIC01776B
Tastatore B005
Tracer Point B005
Taster B005
Palpeur B005
Palpador B005

303/304/305



**T-REX
T-REX ADVANCE**

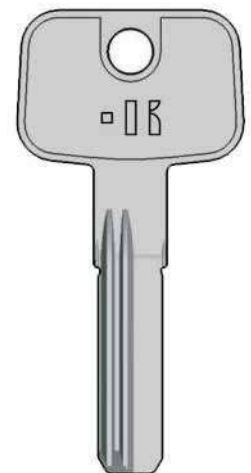

STANDARD

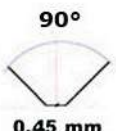

RIC01793B
Fresino HB020
Cutter HB020
Fräser HB020
Fraise HB020
Fresa HB020



RIC01794B
Tastatore B020
Tracer Point B020
Taster B020
Palpeur B020
Palpador B020



PUNTO

POT4

TO FIT: **POTENT (I)**

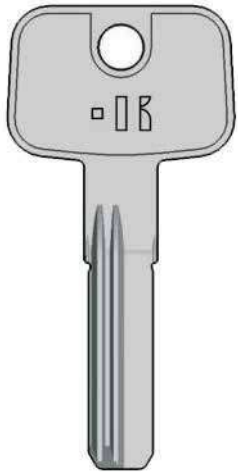

POT4



NINJA TOTAL



NINJA VORTEX



VERSA

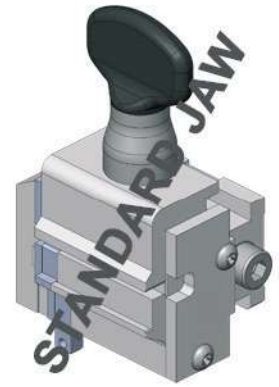
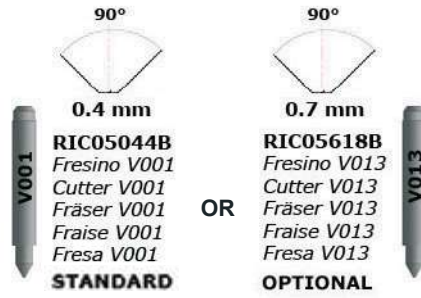

TO FIT: **POTENT (I)**

4000



NINJA TOTAL



NINJA VORTEX



VERSA

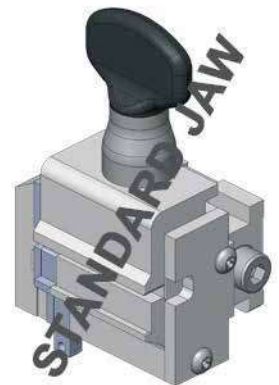

OPZ10584B
Adattatore AV11
Adaptor AV11
Adapter AV11
Adaptateur AV11
Adaptador AV11
OPTIONAL



OPTIONAL



1.5 mm

RIC01820B
Fresino HC003
Cutter HC003
Fräser HC003
Fraise HC003
Fresa HC003



RIC01813B
Tastatore C003
Tracer Point C003
Taster C003
Palpeur C003
Palpador C003

STANDARD

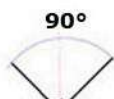

0.45 mm

RIC01793B
Fresino HB020
Cutter HB020
Fräser HB020
Fraise HB020
Fresa HB020



RIC01794B
Tastatore B020
Tracer Point B020
Taster B020
Palpeur B020
Palpador B020



303/304/305



**T-REX
T-REX ADVANCE**



PUNTO

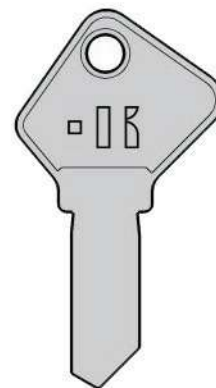

PR8



1.5 mm



RIC05274B
Fresino V012
Cutter V012
Fräser V012
Fraise V012
Fresa V012

OPTIONAL

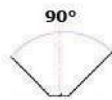

0.4 mm



RIC05044B
Fresino V001
Cutter V001
Fräser V001
Fraise V001
Fresa V001

STANDARD

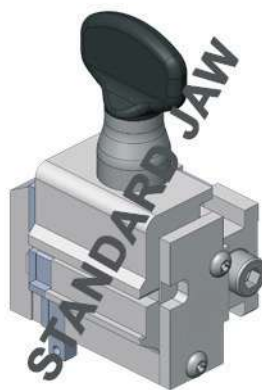

NINJA TOTAL



NINJA VORTEX



VERSA

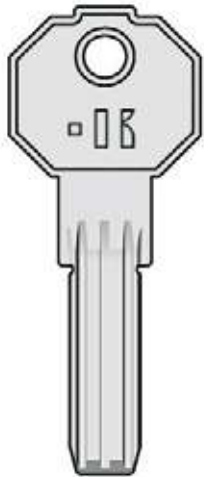

PR16



303/304/305



**T-REX
T-REX ADVANCE**



PUNTO

OPTIONAL

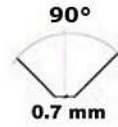

RIC01791B
Fresino HB001
Cutter HB001
Fräser HB001
Fraise HB001
Fresa HB001



RIC01792B
Tastatore B001
Tracer Point B001
Taster B001
Palpeur B001
Palpador B001

STANDARD

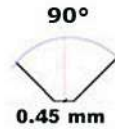

RIC01793B
Fresino HB020
Cutter HB020
Fräser HB020
Fraise HB020
Fresa HB020



RIC01794B
Tastatore B020
Tracer Point B020
Taster B020
Palpeur B020
Palpador B020



NINJA TOTAL



NINJA VORTEX



VERSA

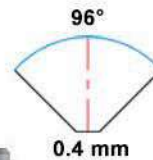

RIC05262B
Fresino V006
Cutter V006
Fräser V006
Fraise V006
Fresa V006
OPTIONAL

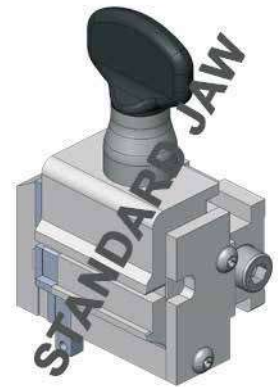

OPTIONAL



1.5 mm

RIC01820B
Fresino HC003
Cutter HC003
Fräser HC003
Fraise HC003
Fresa HC003



RIC01813B
Tastatore C003
Tracer Point C003
Taster C003
Palpeur C003
Palpador C003



303/304/305



**T-REX
T-REX ADVANCE**



PUNTO

20 / 23

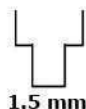
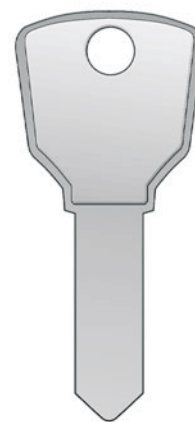

1.5 mm

RIC05274B
Fresino V012
Cutter V012
Fräser V012
Fraise V012
Fresa V012



OPTIONAL

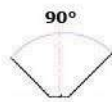

90°

0.4 mm

RIC05044B
Fresino V001
Cutter V001
Fräser V001
Fraise V001
Fresa V001



STANDARD

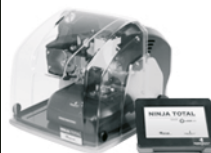
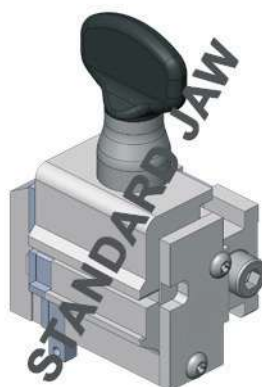

NINJA TOTAL



NINJA VORTEX



VERSA

K1

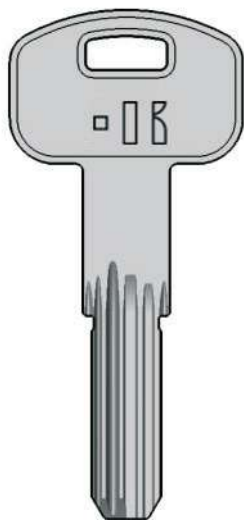

SEC9



303/304/305



**T-REX
T-REX ADVANCE**



PUNTO

STANDARD

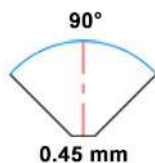

0.45 mm

RIC01793B
Fresino HB020
Cutter HB020
Fräser HB020
Fraise HB020
Fresa HB020



RIC01794B
Tastatore B020
Tracer Point B020
Taster B020
Palpeur B020
Palpador B020

OPTIONAL

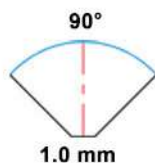

1.0 mm

RIC01822B
Fresino HB043
Cutter HB043
Fräser HB043
Fraise HB043
Fresa HB043



RIC01823B
Tastatore B043
Tracer Point B043
Taster B043
Palpeur B043
Palpador B043



NINJA TOTAL



NINJA VORTEX



VERSA



0.4 mm

RIC05044B
Fresino V001
Cutter V001
Fräser V001
Fraise V001
Fresa V001
STANDARD



OR



0.7 mm

RIC05618B
Fresino V013
Cutter V013
Fräser V013
Fraise V013
Fresa V013
OPTIONAL

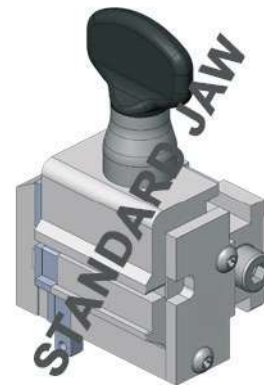

TO
FIT :

SECUREMME (I)



0.4 mm



RIC05044B
Fresino V001
Cutter V001
Fräser V001
Fraise V001
Fresa V001
STANDARD



OPZ10584B
Adattatore AV11
Adaptor AV11
Adapter AV11
Adaptateur AV11
Adaptador AV11
OPTIONAL



NINJA TOTAL



NINJA VORTEX



VERSA

K2

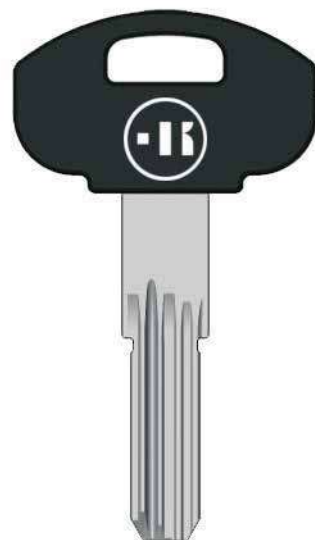

SEC11P

TO
FIT :

SECUREMME (I)

STANDARD

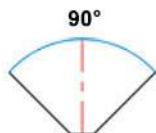

0.45 mm

RIC01793B
Fresino HB020
Cutter HB020
Fräser HB020
Fraise HB020
Fresa HB020



RIC01794B
Tastatore B020
Tracer Point B020
Taster B020
Palpeur B020
Palpador B020

303/304/305



**T-REX
T-REX ADVANCE**



PUNTO

K3



OPTIONAL

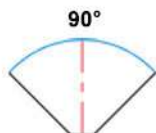

0.9 mm

RIC01775B
Fresino HB005
Cutter HB005
Fräser HB005
Fraise HB005
Fresa HB005



RIC01776B
Tastatore B005
Tracer Point B005
Taster B005
Palpeur B005
Palpador B005

TO FIT: SECUREMME (I)

K3

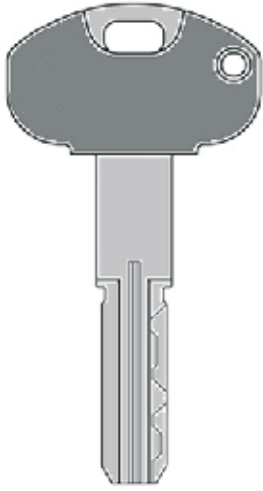

NINJA TOTAL



NINJA VORTEX



VERSA

OPTIONAL

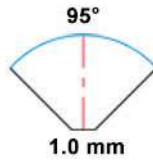

RIC08161B
 Fresino V039
 Cutter V039
 Fräser V039
 Fraise V039
 Fresa V039

OPZ10407B

Morsetto C37
 Jaw C37
 Spannbacke C37
 Étau C37
 Mordaza C37



TO FIT: SECUREMME (I)

K5

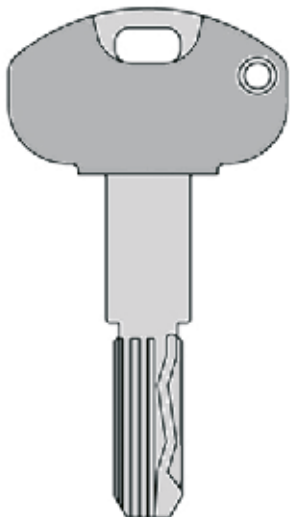

NINJA TOTAL



NINJA VORTEX



VERSA

OPTIONAL

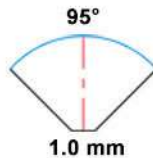

RIC08161B
 Fresino V039
 Cutter V039
 Fräser V039
 Fraise V039
 Fresa V039

OPZ10407B

Morsetto C37
 Jaw C37
 Spannbacke C37
 Étau C37
 Mordaza C37

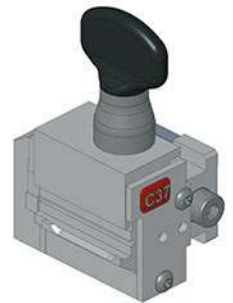

TO
FIT :

SECUREMME (I)

OPTIONAL

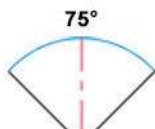

1.2 mm



RIC10506B
Fresino V050
Cutter V050
Fräser V050
Fraise V050
Fresa V050

OPZ10407B
Morsetto C37
Jaw C37
Spannbacke C37
Étau C37
Mordaza C37



NINJA TOTAL



NINJA VORTEX



VERSA

EVOK22/EVOK64



YMA



TO
FIT :

SECURYSTAR (F)

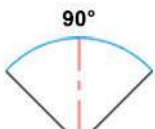

0.4 mm



RIC05044B
Fresino V001
Cutter V001
Fräser V001
Fraise V001
Fresa V001
STANDARD

OPZ10143B
Morsetto C31
Jaw C31
Spannbacke C31
Étau C31
Mordaza C31
OPTIONAL



NINJA TOTAL



NINJA VORTEX



VERSA

**MAXISTAR
PROSTAR**





KYR1



303/304/305

**T-REX
T-REX ADVANCE**



NINJA TOTAL



NINJA VORTEX



VERSA

OPTIONAL

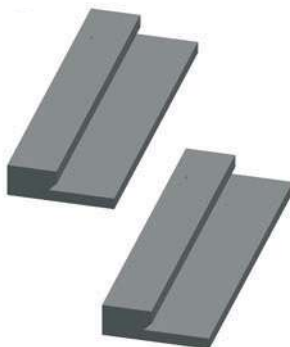

OPZ06644B

*Adattatori per Kaba Micro e KYR
Adaptors for Kaba Micro and KYR
Adaptors für Kaba Micro und KYR
Adaptateurs pour Kaba Micro et KYR
Adaptadores para Kaba Micro y KYR*

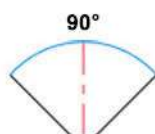

0.4 mm



RIC05044B
*Fresino V001
Cutter V001
Fräser V001
Fraise V001
Fresa V001
STANDARD*

OPZ07800B

*Morsetto C15
Jaw C15
Spannbacke C15
Étau C15
Mordaza C15
OPTIONAL*



OPTIONAL

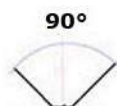

0.9 mm

RIC01775B

Fresino HB005
Cutter HB005
Fräser HB005
Fraise HB005
Fresa HB005



RIC01776B

Tastatore B005
Tracer Point B005
Taster B005
Palpeur B005
Palpador B005

STANDARD



0.45 mm

RIC01793B

Fresino HB020
Cutter HB020
Fräser HB020
Fraise HB020
Fresa HB020



RIC01794B

Tastatore B020
Tracer Point B020
Taster B020
Palpeur B020
Palpador B020



303/304/305



**T-REX
T-REX ADVANCE**



PUNTO

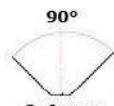
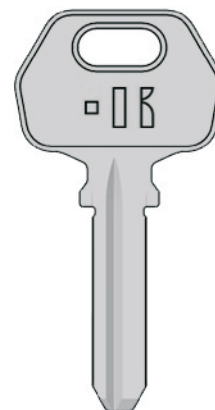

0.4 mm

RIC05044B

Fresino V001
Cutter V001
Fräser V001
Fraise V001
Fresa V001



0.7 mm

RIC05618B

Fresino V013
Cutter V013
Fräser V013
Fraise V013
Fresa V013



OR

STANDARD

OPTIONAL

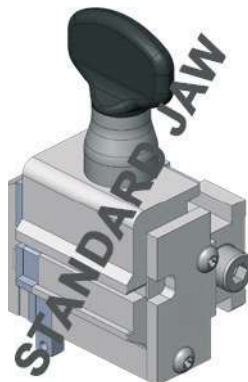

NINJA TOTAL



NINJA VORTEX



VERSA

**STS MINI
MEGA 6**



STS6S



STANDARD

90°

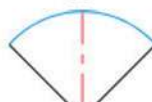

0.45 mm

RIC01793B
Fresino HB020
Cutter HB020
Fräser HB020
Fraise HB020
Fresa HB020



RIC01794B
Tastatore B020
Tracer Point B020
Taster B020
Palpeur B020
Palpador B020



MSTS

Adattatori per chiavi STS
Adaptors for STS keys
Adapters für STS-Schlüssel
Adaptateurs pour clés STS
Adaptadores para llaves STS

OPTIONAL

OPTIONAL

90°



1.0 mm

RIC01822B
Fresino HB043
Cutter HB043
Fräser HB043
Fraise HB043
Fresa HB043



RIC01823B
Tastatore B043
Tracer Point B043
Taster B043
Palpeur B043
Palpador B043



90°



0.4 mm



RIC05044B
Fresino V001
Cutter V001
Fräser V001
Fraise V001
Fresa V001
STANDARD

90°



0.7 mm



RIC05618B
Fresino V013
Cutter V013
Fräser V013
Fraise V013
Fresa V013
OPTIONAL

OR

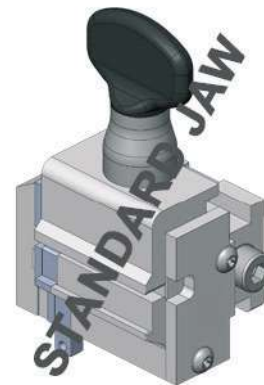

TO
FIT :

STS (E)

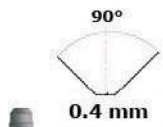

0.4 mm

RIC05044B
Fresino V001
Cutter V001
Fräser V001
Fraise V001
Fresa V001
STANDARD

OR

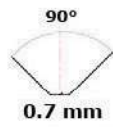

0.7 mm

RIC05618B
Fresino V013
Cutter V013
Fräser V013
Fraise V013
Fresa V013
OPTIONAL

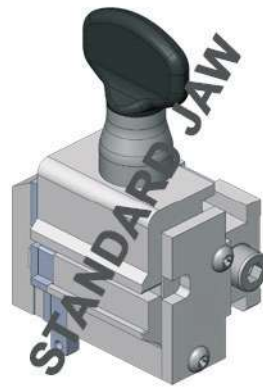

NINJA TOTAL



NINJA VORTEX



VERSA

CS

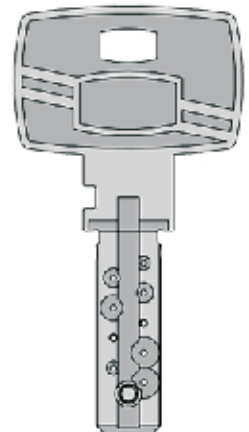

TO
FIT :

STS (E)

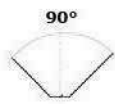

0.8 mm

RIC06104B
Fresino V021
Cutter V021
Fräser V021
Fraise V021
Fresa V021
OPTIONAL

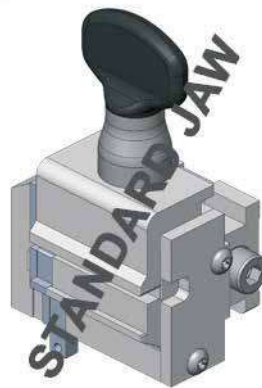

NINJA TOTAL



NINJA VORTEX



VERSA

ST8+ST6

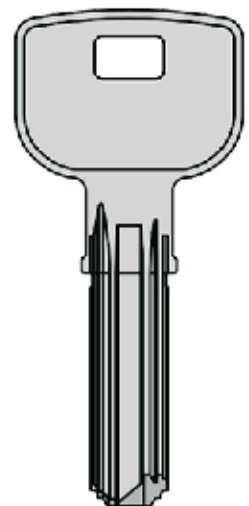

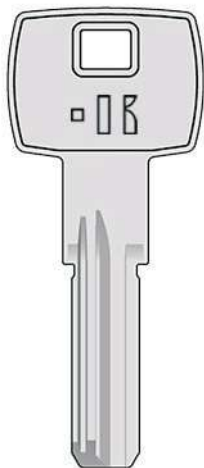

MR1



303/304/305
T-REX
T-REX ADVANCE
PUNTO

STANDARD

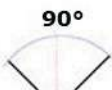

90°
0.45 mm

RIC01793B
Fresino HB020
Cutter HB020
Fräser HB020
Fraise HB020
Fresa HB020



HB020



B020

RIC01794B
Tastatore B020
Tracer Point B020
Taster B020
Palpeur B020
Palpador B020



NINJA TOTAL
NINJA VORTEX
VERSA



90°
0.4 mm

RIC05044B
Fresino V001
Cutter V001
Fräser V001
Fraise V001
Fresa V001
STANDARD



V001

OR

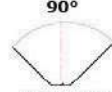

90°
0.7 mm

RIC05618B
Fresino V013
Cutter V013
Fräser V013
Fraise V013
Fresa V013
OPTIONAL



V013

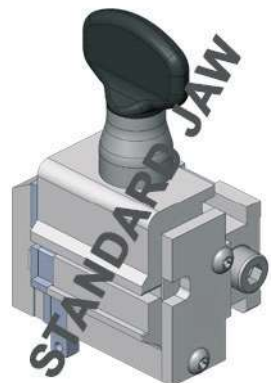

STANDARD

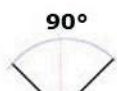

0.45 mm

RIC01793B
Fresino HB020
Cutter HB020
Fräser HB020
Fraise HB020
Fresa HB020



RIC01794B
Tastatore B020
Tracer Point B020
Taster B020
Palpeur B020
Palpador B020



303/304/305



PUNTO

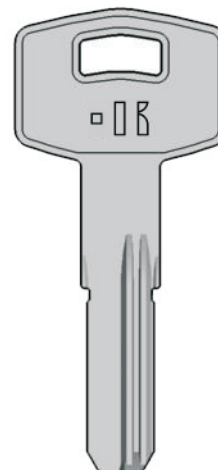

0.4 mm



RIC05044B
Fresino V001
Cutter V001
Fräser V001
Fraise V001
Fresa V001

STANDARD

OR

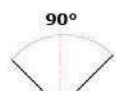

0.7 mm



RIC05618B
Fresino V013
Cutter V013
Fräser V013
Fraise V013
Fresa V013

OPTIONAL

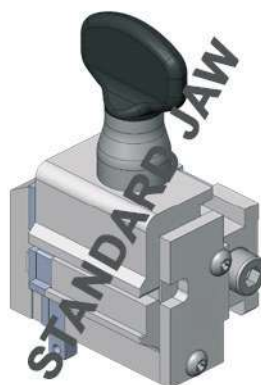

NINJA TOTAL



NINJA VORTEX



VERSA



TAR7



TAR7S

TX70 / TX80



MLN



303/304/305

**T-REX
T-REX ADVANCE**

PUNTO



NINJA TOTAL



NINJA VORTEX



VERSA

STANDARD

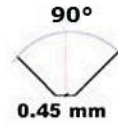

RIC01793B
Fresino HB020
Cutter HB020
Fräser HB020
Fraise HB020
Fresa HB020



RIC01794B
Tastatore B020
Tracer Point B020
Taster B020
Palpeur B020
Palpador B020

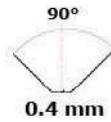

RIC05044B
Fresino V001
Cutter V001
Fräser V001
Fraise V001
Fresa V001
STANDARD

OR

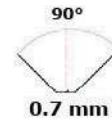

RIC05618B
Fresino V013
Cutter V013
Fräser V013
Fraise V013
Fresa V013
OPTIONAL

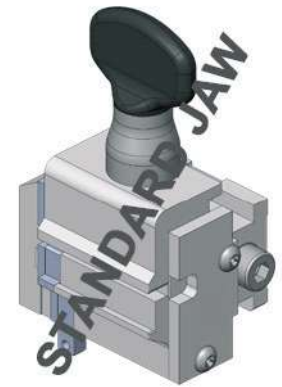

STANDARD

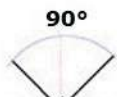

0.45 mm

RIC01793B
Fresino HB020
Cutter HB020
Fräser HB020
Fraise HB020
Fresa HB020



RIC01794B
Tastatore B020
Tracer Point B020
Taster B020
Palpeur B020
Palpador B020



303/304/305



**T-REX
T-REX ADVANCE**



PUNTO

T60/T80

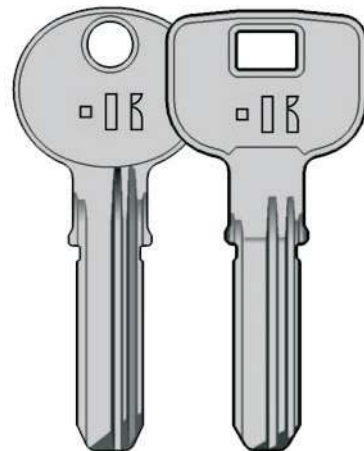

TES7



TES4

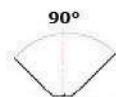

0.4 mm

RIC05044B
Fresino V001
Cutter V001
Fräser V001
Fraise V001
Fresa V001
STANDARD

OR

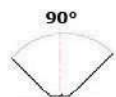

0.7 mm

RIC05618B
Fresino V013
Cutter V013
Fräser V013
Fraise V013
Fresa V013
OPTIONAL

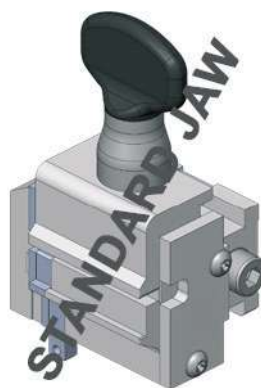

NINJA TOTAL



NINJA VORTEX



VERSA

TO FIT: TESA (E)

T10

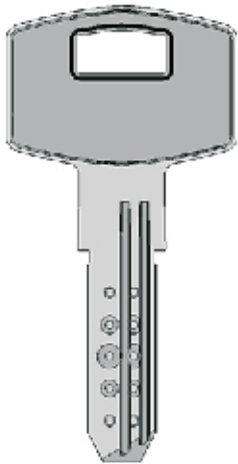

OPTIONAL

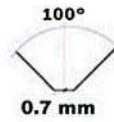

0.7 mm

RIC01789B
Fresino HB042
Cutter HB042
Fräser HB042
Fraise HB042
Fresa HB042



RIC01790B
Tastatore B042
Tracer Point B042
Taster B042
Palpeur B042
Palpador B042

TO FIT: TESA (E)

ST6

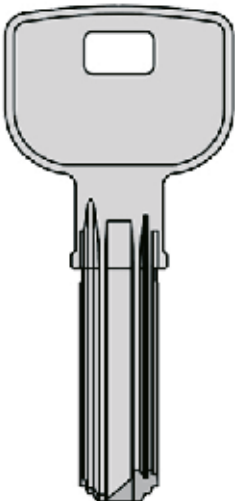

OPTIONAL

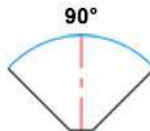

0.8 mm

RIC06104B
Fresino V021
Cutter V021
Fräser V021
Fraise V021
Fresa V021



OPZ10454B
Morsetto C40
Jaw C40
Spannbacke C40
Étau C40
Mordaza C40



OPTIONAL



0.8 mm

RIC01783B
Fresino HB026
Cutter HB026
Fräser HB026
Fraise HB026
Fresa HB026



RIC01784B
Tastatore B026
Tracer Point B026
Taster B026
Palpeur B026
Palpador B026



303/304/305



**T-REX
T-REX ADVANCE**



PUNTO

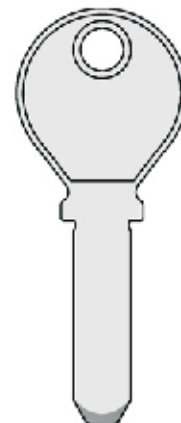

→ KESO



0.5 mm

RIC05084B
Fresino V004
Cutter V004
Fräser V004
Fraise V004
Fresa V004
OPTIONAL

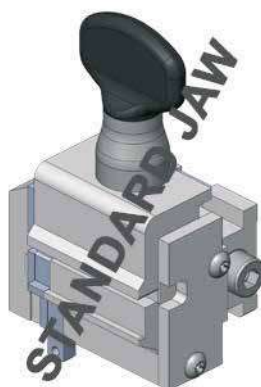

NINJA TOTAL



NINJA VORTEX



VERSA

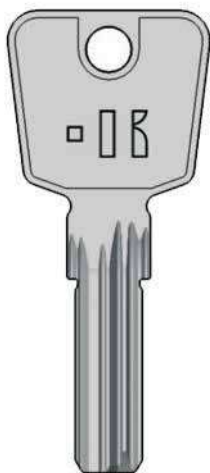

TIN7



303/304/305

**T-REX
T-REX ADVANCE**

PUNTO

STANDARD

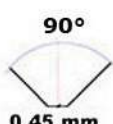

RIC01793B
Fresino HB020
Cutter HB020
Fräser HB020
Fraise HB020
Fresa HB020



RIC01794B
Tastatore B020
Tracer Point B020
Taster B020
Palpeur B020
Palpador B020

OPTIONAL

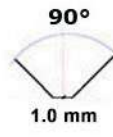

RIC01822B
Fresino HB043
Cutter HB043
Fräser HB043
Fraise HB043
Fresa HB043



RIC01823B
Tastatore B043
Tracer Point B043
Taster B043
Palpeur B043
Palpador B043



NINJA TOTAL

NINJA VORTEX

VERSA

90°

0.4 mm

RIC05044B
Fresino V001
Cutter V001
Fräser V001
Fraise V001
Fresa V001

STANDARD

V001

OR

90°

0.7 mm

RIC05618B
Fresino V013
Cutter V013
Fräser V013
Fraise V013
Fresa V013

OPTIONAL

V013

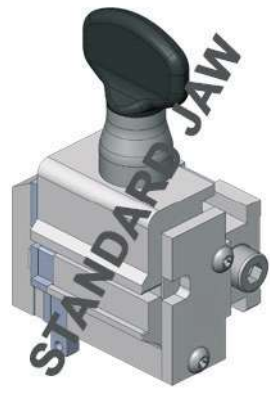

TO
FIT :

TITAN (SLO)



RIC05266B
Fresino V008
Cutter V008
Fräser V008
Fraise V008
Fresa V008

OPTIONAL

106°



0.4 mm

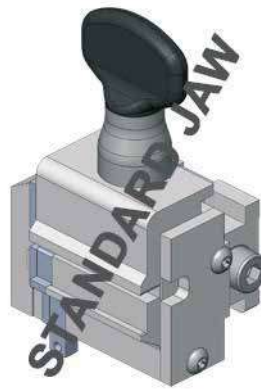

NINJA TOTAL



NINJA VORTEX



VERSA

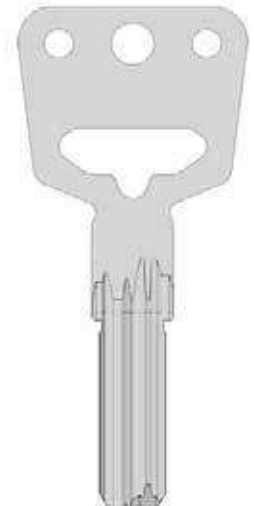

K5
K5D
K56
PPD5BB
T61BB



TO
FIT :

TOPEX (US)

STANDARD

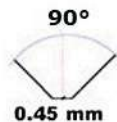

RIC01793B
Fresino HB020
Cutter HB020
Fräser HB020
Fraise HB020
Fresa HB020



RIC01794B
Tastatore B020
Tracer Point B020
Taster B020
Palpeur B020
Palpador B020



303/304/305



**T-REX
T-REX ADVANCE**



PUNTO

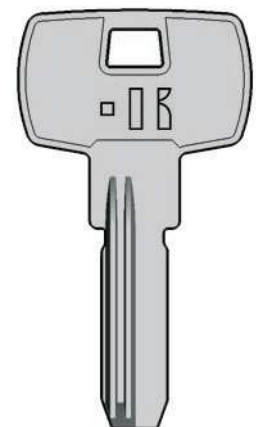

TPX1



KEY



303/304/305



**T-REX
T-REX ADVANCE**



PUNTO



NINJA TOTAL



NINJA VORTEX



VERSA

STANDARD

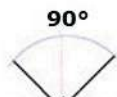

0.45 mm

RIC01793B
Fresino HB020
Cutter HB020
Fräser HB020
Fraise HB020
Fresa HB020



RIC01794B
Tastatore B020
Tracer Point B020
Taster B020
Palpeur B020
Palpador B020



0.4 mm

RIC05044B
Fresino V001
Cutter V001
Fräser V001
Fraise V001
Fresa V001



STANDARD

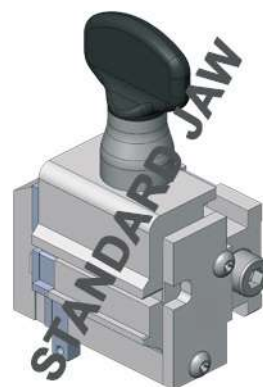

OR



0.7 mm

RIC05618B
Fresino V013
Cutter V013
Fräser V013
Fraise V013
Fresa V013



OPTIONAL

OR

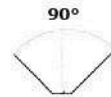

0.6 mm

RIC05612B
Fresino V014
Cutter V014
Fräser V014
Fraise V014
Fresa V014



OPTIONAL

TO
FIT :

TOVER (E)



RIC05266B
Fresino V008
Cutter V008
Fräser V008
Fraise V008
Fresa V008

OPTIONAL

106°

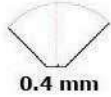

0.4 mm

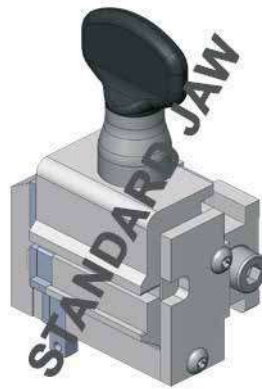

NINJA TOTAL



NINJA VORTEX



VERSA



TO
FIT :

UCEM (ES)

OPTIONAL

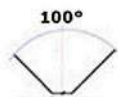

0.7 mm

RIC01789B
Fresino HB042
Cutter HB042
Fräser HB042
Fraise HB042
Fresa HB042



RIC01790B
Tastatore B042
Tracer Point B042
Taster B042
Palpeur B042
Palpador B042



303/304/305



**T-REX
T-REX ADVANCE**



PUNTO



2000



TO FIT: UCEM (ES)

2000



NINJA TOTAL



NINJA VORTEX



VERSA

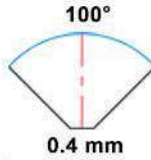

RIC05264B
Fresino V007
Cutter V007
Fräser V007
Fraise V007
Fresa V007
OPTIONAL

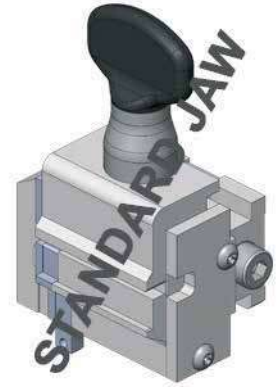

TO FIT: UNION (GB)



303/304/305



**T-REX
T-REX ADVANCE**



PUNTO

OPTIONAL

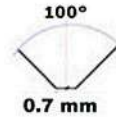

RIC01789B
Fresino HB042
Cutter HB042
Fräser HB042
Fraise HB042
Fresa HB042



RIC01790B
Tastatore B042
Tracer Point B042
Taster B042
Palpeur B042
Palpador B042

TO
FIT :

UNION (GB)

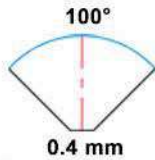

RIC05264B
 Fresino V007
 Cutter V007
 Fräser V007
 Fraise V007
 Fresa V007
 OPTIONAL

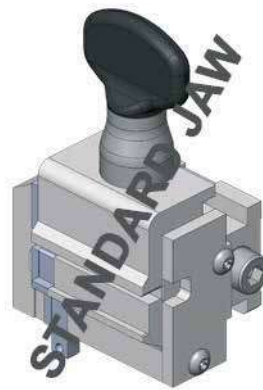

NINJA TOTAL



NINJA VORTEX



VERSA



TO
FIT :

UNION (GB)

OPTIONAL

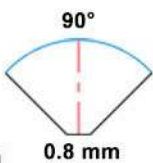

RIC06368B
 Fresino V022
 Cutter V022
 Fräser V022
 Fraise V022
 Fresa V022

OPZ10427B
 Morsetto C39
 Jaw C39
 Spannbacke C39
 Étau C39
 Mordaza C39



NINJA TOTAL



NINJA VORTEX



VERSA



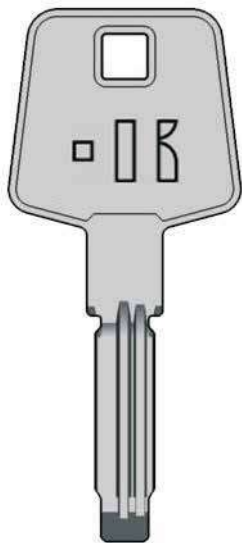

VC20



VC15



304/305



**T-REX
T-REX ADVANCE**

STANDARD

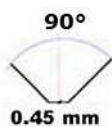

0.45 mm

RIC01793B
Fresino HB020
Cutter HB020
Fräser HB020
Fraise HB020
Fresa HB020



RIC01794B
Tastatore B020
Tracer Point B020
Taster B020
Palpeur B020
Palpador B020

OPTIONAL

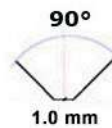

1.0 mm

RIC01822B
Fresino HB043
Cutter HB043
Fräser HB043
Fraise HB043
Fresa HB043



RIC01823B
Tastatore B043
Tracer Point B043
Taster B043
Palpeur B043
Palpador B043



NINJA TOTAL



NINJA VORTEX



VERSA



0.4 mm

RIC05044B
Fresino V001
Cutter V001
Fräser V001
Fraise V001
Fresa V001

STANDARD

OR



0.7 mm

RIC05618B
Fresino V013
Cutter V013
Fräser V013
Fraise V013
Fresa V013

OPTIONAL

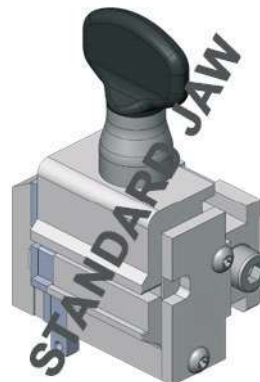

TO
FIT :

VACHETTE (F)

OPTIONAL



RIC06368B
Fresino V022
Cutter V022
Fräser V022
Fraise V022
Fresa V022

OPZ10427B
Morsetto C39
Jaw C39
Spannbacke C39
Étau C39
Mordaza C39



NINJA TOTAL



NINJA VORTEX



VERSA

Vercy



TO
FIT :

VIRO (I)

STANDARD

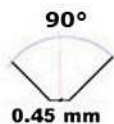

RIC01793B
Fresino HB020
Cutter HB020
Fräser HB020
Fraise HB020
Fresa HB020



RIC01794B
Tastatore B020
Tracer Point B020
Taster B020
Palpeur B020
Palpador B020



303/304/305



**T-REX
T-REX ADVANCE**



PUNTO

EURO-PRO

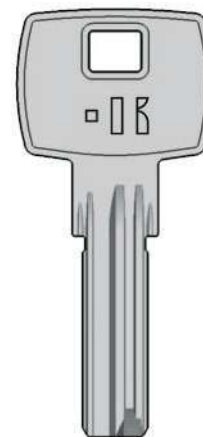

VR19

OPTIONAL

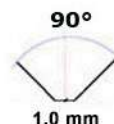

RIC01822B
Fresino HB043
Cutter HB043
Fräser HB043
Fraise HB043
Fresa HB043



RIC01823B
Tastatore B043
Tracer Point B043
Taster B043
Palpeur B043
Palpador B043

TO FIT: VIRO (I)

EURO-PRO

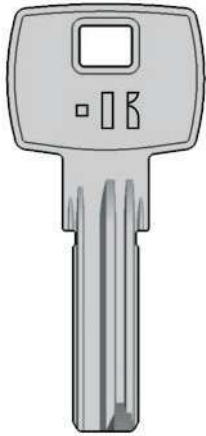

VR19



NINJA TOTAL



NINJA VORTEX



VERSA

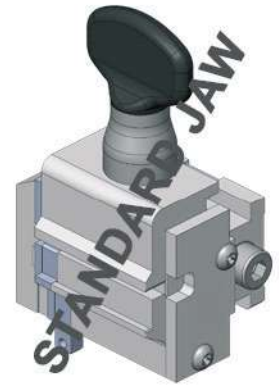
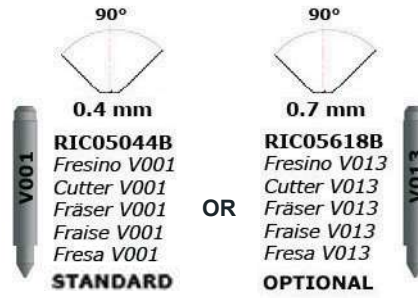

TO FIT: VIRO (I)

PALLADIUM

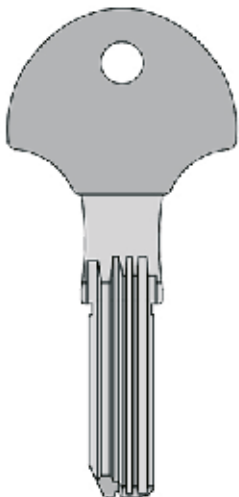

303/304/305



T-REX
T-REX ADVANCE



PUNTO

OPTIONAL



RIC01786B
Tastatore B039
Tracer Point B039
Taster B039
Palpeur B039
Palpador B039

TO
FIT :

VIRO (I)

OPTIONAL

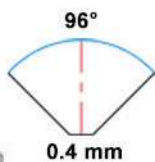

RIC05262B
Fresino V006
Cutter V006
Fräser V006
Fraise V006
Fresa V006

OPZ08363B
Morsetto C20
Jaw C20
Spannbacke C20
Étau C20
Mordaza C20



NINJA TOTAL



NINJA VORTEX



VERSA

PALLADIUM

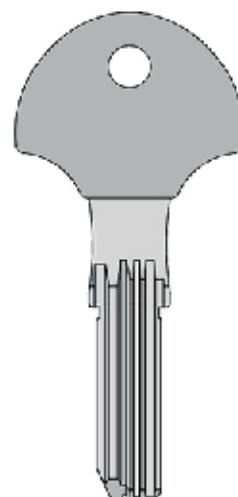

TO
FIT :

WEST (J)

OPTIONAL

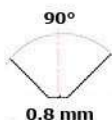

RIC01781B
Fresino HB015
Cutter HB015
Fräser HB015
Fraise HB015
Fresa HB015

RIC01782B
Tastatore B015
Tracer Point B015
Taster B015
Palpeur B015
Palpador B015

303/304/305



**T-REX
T-REX ADVANCE**



PUNTO



STANDARD

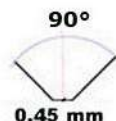

RIC01793B
Fresino HB020
Cutter HB020
Fräser HB020
Fraise HB020
Fresa HB020

RIC01794B
Tastatore B020
Tracer Point B020
Taster B020
Palpeur B020
Palpador B020

TO FIT: WEST (J)



NINJA TOTAL



NINJA VORTEX



VERSA

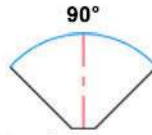

90°

0.4 mm



RIC05044B
Fresino V001
Cutter V001
Fräser V001
Fraise V001
Fresa V001
STANDARD

OPZ07800B
Morsetto C15
Jaw C15
Spannbacke C15
Étau C15
Mordaza C15
OPTIONAL



TO FIT: WILKA (D)

P3/PR300

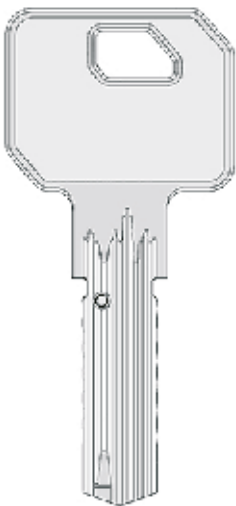

NINJA TOTAL



NINJA VORTEX



VERSA

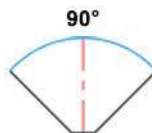

90°

0.4 mm



RIC05044B
Fresino V001
Cutter V001
Fräser V001
Fraise V001
Fresa V001
STANDARD

OPZ08375B
Morsetto C19
Jaw C19
Spannbacke C19
Étau C19
Mordaza C19
OPTIONAL

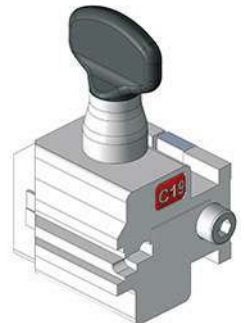

OPTIONAL

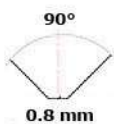

RIC01781B
Fresino HB015
Cutter HB015
Fräser HB015
Fraise HB015
Fresa HB015



RIC01782B
Tastatore B015
Tracer Point B015
Taster B015
Palpeur B015
Palpador B015

STANDARD

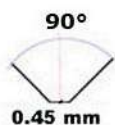

RIC01793B
Fresino HB020
Cutter HB020
Fräser HB020
Fraise HB020
Fresa HB020



RIC01794B
Tastatore B020
Tracer Point B020
Taster B020
Palpeur B020
Palpador B020



303/304/305



**T-REX
T-REX ADVANCE**



PUNTO

W3600



W3600

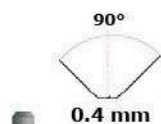

V001
RIC05044B
Fresino V001
Cutter V001
Fräser V001
Fraise V001
Fresa V001
STANDARD

OR

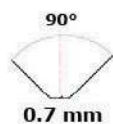

V013
RIC05618B
Fresino V013
Cutter V013
Fräser V013
Fraise V013
Fresa V013
OPTIONAL

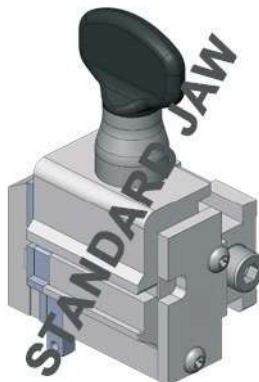

NINJA TOTAL



NINJA VORTEX



VERSA

TO FIT: **WILKA (D)**

PR100-CARAT

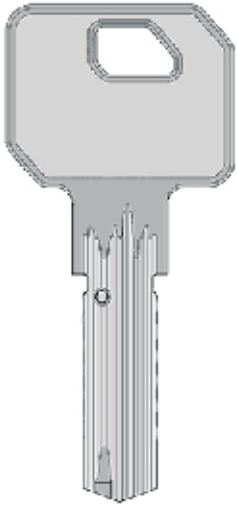

WPL



NINJA TOTAL



NINJA VORTEX



VERSA

OPTIONAL

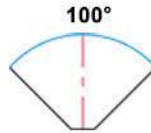

0.4 mm

RIC05264B
 Fresino V007
 Cutter V007
 Fräser V007
 Fraise V007
 Fresa V007



OPZ06039B

Morsetto C08
 Jaw C08
 Spannbacke C08
 Étau C08
 Mordaza C08



TO FIT: **WINKHAUS (D)**

X-TRA

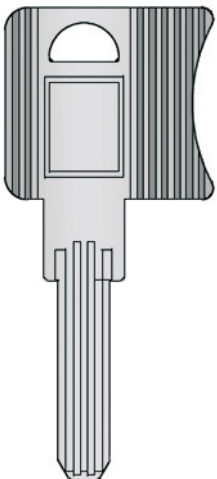

WPL



303/304/305



**T-REX
 T-REX ADVANCE**



PUNTO

STANDARD

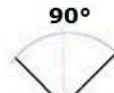

0.45 mm

RIC01793B
 Fresino HB020
 Cutter HB020
 Fräser HB020
 Fraise HB020
 Fresa HB020



RIC01794B
 Tastatore B020
 Tracer Point B020
 Taster B020
 Palpeur B020
 Palpador B020

TO
FIT :

WINKHAUS (D)



OR

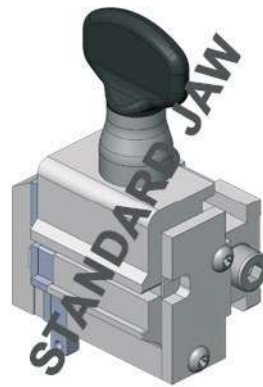

NINJA TOTAL



NINJA VORTEX



VERSA

X-TRA

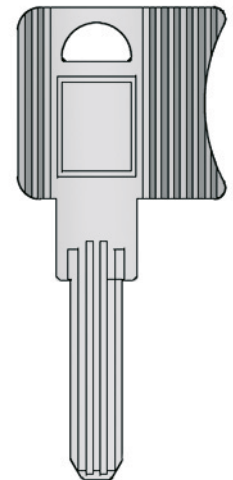

TO
FIT :

WINKHAUS (D)

OPTIONAL

OPZ09531B
Morsetto N25
Jaw N25
Spannbacke N25
Étau N25
Mordaza N25

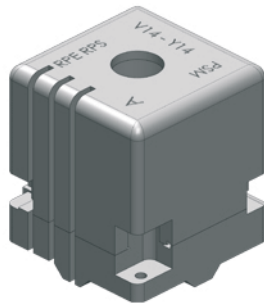

NINJA LASER



NINJA TOTAL

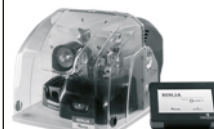

**NINJA
NINJA DARK**

RPE-RPS

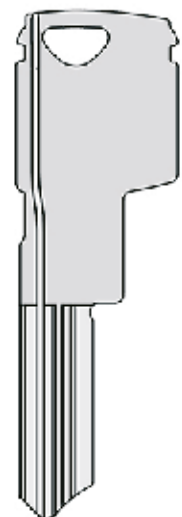

RPE-RPS

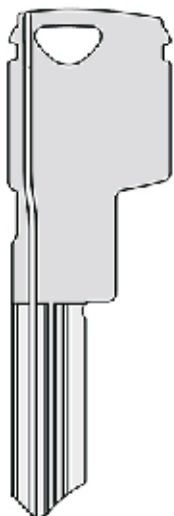

NINJA VORTEX



VERSA



NINJA TOTAL



NINJA VORTEX



VERSA

FOR EDGE CUT

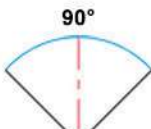

0.4 mm

RIC05044B

Fresino V001
Cutter V001
Fräser V001
Fraise V001
Fresa V001



STANDARD

OPZ010307B

Morsetto C35
Jaw C35
Spannbacke C35
Étau C35
Mordaza C35
OPTIONAL



OPTIONAL

FOR DIMPLE CUT

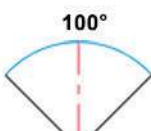

0.4 mm

RIC05264B

Fresino V007
Cutter V007
Fräser V007
Fraise V007
Fresa V007



OPZ010307B

Morsetto C35
Jaw C35
Spannbacke C35
Étau C35
Mordaza C35



TO
FIT :

WINKHAUS (D)

OPTIONAL

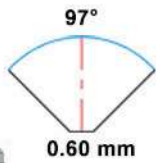

RIC010290B
Fresino V047
Cutter V047
Fräser V047
Fraise V047
Fresa V047

OPZ10287B
Morsetto C32
Jaw C32
Spannbacke C32
Étau C32
Mordaza C32



NINJA TOTAL



NINJA VORTEX



VERSA

ON-TRA

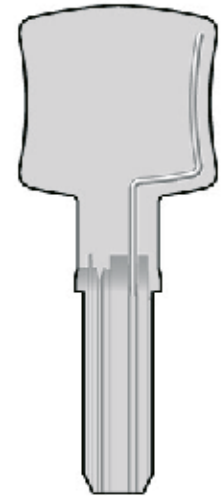

TO
FIT :

WINKHAUS (D)

OPTIONAL

OPZ09531B
Morsetto N25
Jaw N25
Spannbacke N25
Étau N25
Mordaza N25

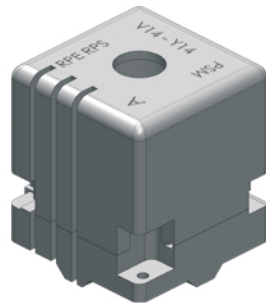

NINJA LASER



NINJA TOTAL

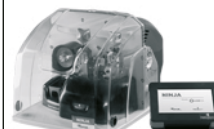

**NINJA
NINJA DARK**

AZ VS
RPE-RPS

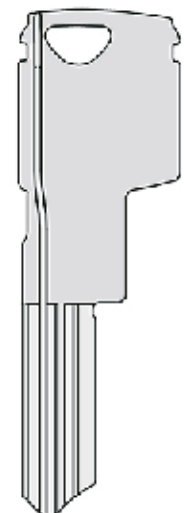

TO FIT: YALE (GB)

MARTE

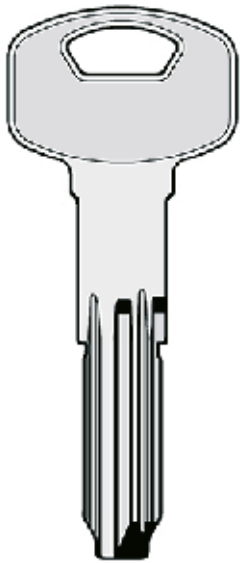

NINJA TOTAL



NINJA VORTEX



VERSA

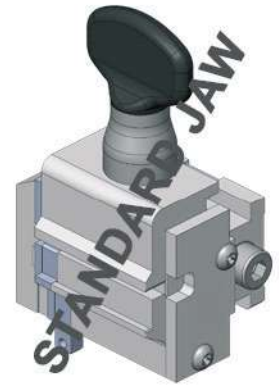
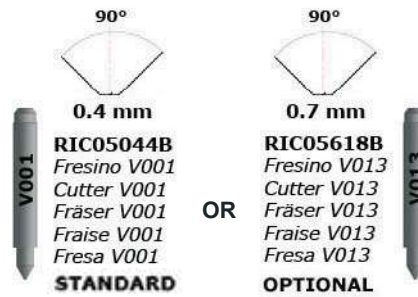

TO FIT: YALE (GB)

230

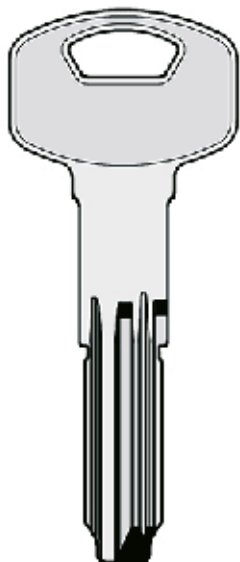

303/304/305



T-REX
T-REX ADVANCE



PUNTO

OPTIONAL

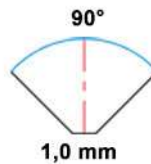

RIC01822B
Fresino HB043
Cutter HB043
Fräser HB043
Fraise HB043
Fresa HB043



RIC01823B
Tastatore B043
Tracer Point B043
Taster B043
Palpeur B043
Palpador B043

STANDARD

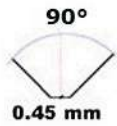

RIC01793B
Fresino HB020
Cutter HB020
Fräser HB020
Fraise HB020
Fresa HB020



RIC01794B
Tastatore B020
Tracer Point B020
Taster B020
Palpeur B020
Palpador B020



303/304/305



**T-REX
T-REX ADVANCE**



PUNTO



**YY3P
YY5P**

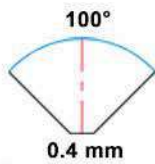

RIC05264B
Fresino V007
Cutter V007
Fräser V007
Fraise V007
Fresa V007
OPTIONAL

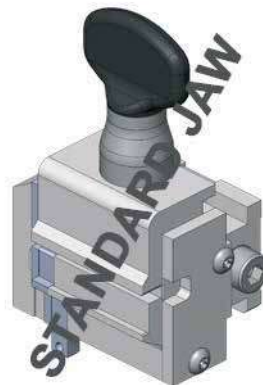

NINJA TOTAL



NINJA VORTEX



VERSA

XL



YY13P



303/304/305



**T-REX
T-REX ADVANCE**



PUNTO



NINJA TOTAL



NINJA VORTEX



VERSA

OPTIONAL

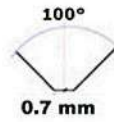

0.7 mm

RIC01789B
Fresino HB042
Cutter HB042
Fräser HB042
Fraise HB042
Fresa HB042



RIC01790B
Tastatore B042
Tracer Point B042
Taster B042
Palpeur B042
Palpador B042

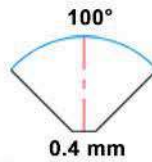

0.4 mm



RIC05264B
Fresino V007
Cutter V007
Fräser V007
Fraise V007
Fresa V007
OPTIONAL

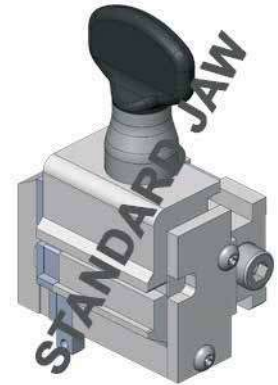

TO
FIT :

ZADI (I)

OPTIONAL

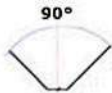

0.9 mm

RIC01775B

Fresino HB005
Cutter HB005
Fräser HB005
Fraise HB005
Fresa HB005



RIC01776B

Tastatore B005
Tracer Point B005
Taster B005
Palpeur B005
Palpador B005



303/304/305



**T-REX
T-REX ADVANCE**



PUNTO



ZAD26

TO
FIT :

ZADI (I)

OPTIONAL



2 mm

RIC01816B

Fresino HC044
Cutter HC044
Fräser HC044
Fraise HC044
Fresa HC044



RIC01817B

Tastatore C044
Tracer Point C044
Taster C044
Palpeur C044
Palpador C044



303/304/305



**T-REX
T-REX ADVANCE**



PUNTO

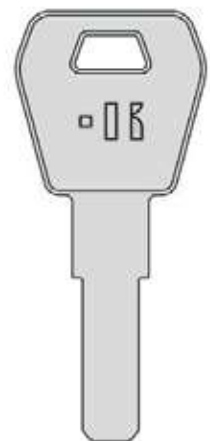

ZAD25

TO FIT: ZEISS IKON (D)



ZI2 ZI2S



NINJA VORTEX



VERSA

OPTIONAL

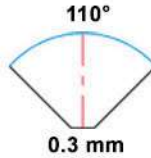

RIC05270B
Fresino V010
Cutter V010
Fräser V010
Fraise V010
Fresa V010

OPZ06039B
Morsetto C08
Jaw C08
Spannbacke C08
Étau C08
Mordaza C08



TO FIT: ZEISS IKON (D)

RW6



NINJA TOTAL



NINJA VORTEX



VERSA

OPTIONAL

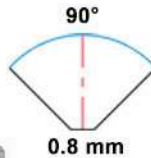

RIC06368B
Fresino V022
Cutter V022
Fräser V022
Fraise V022
Fresa V022

OPZ10427B
Morsetto C39
Jaw C39
Spannbacke C39
Étau C39
Mordaza C39



CHIAVI AUTO / CHIAVI CAMION / ACCESSORI

CAR KEYS / TRUCK KEYS / ACCESSORIES

AUTOSCHLÜSSEL / LKW-SCHLÜSSEL / ZUBEHÖR

CLÉS AUTO / CLÉS CAMION / ACCESSOIRES

LLAVES PARA AUTO / LLAVES PARA CAMIONES / ACCESORIOS



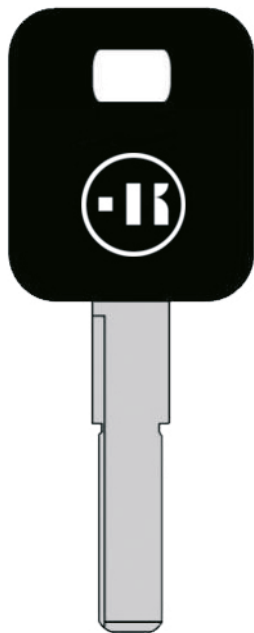

AD66TK1

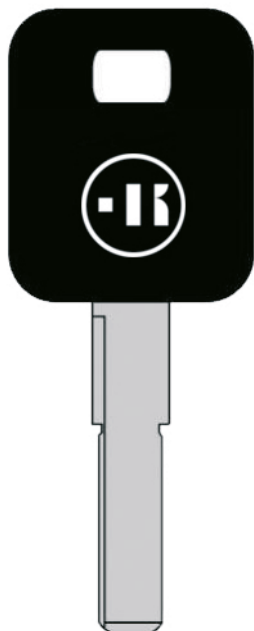

AD66TK8



303/304/305



PUNTO

OPTIONAL

MA

Adattatori per chiavi VAG
Adaptors for VAG keys
Adapters für VAG-Schlüssel
Adaptateurs pour clés VAG
Adaptadores para llaves VAG



STANDARD



2.5 mm

RIC01810B

Fresino HC011
Cutter HC011
Fräser HC011
Fraise HC011
Fresa HC011



RIC01811B

Tastatore C011
Tracer Point C011
Taster C011
Palpeur C011
Palpador C011

OPTIONAL



3.0 mm

RIC01715B

Fresino HC030
Cutter HC030
Fräser HC030
Fraise HC030
Fresa HC030



RIC01716B

Tastatore C030
Tracer Point C030
Taster C030
Palpeur C030
Palpador C030

STANDARD



2,5 mm

RIC01810B

Fresino HC011
Cutter HC011
Fräser HC011
Fraise HC011
Fresa HC011



RIC01811B

Tastatore C011
Tracer Point C011
Taster C011
Palpeur C011
Palpador C011

OPTIONAL



3,0 mm

RIC01715B

Fresino HC030
Cutter HC030
Fräser HC030
Fraise HC030
Fresa HC030



RIC01716B

Tastatore C030
Tracer Point C030
Taster C030
Palpeur C030
Palpador C030

STANDARD

OPZ05223B

Morsetto C-994
Jaw C-994
Spannbacke C-994
Étau C-994
Mordaza C-994

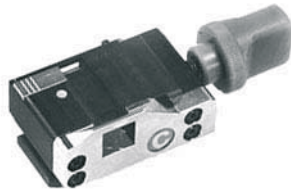

994 LASER



2.5 mm



RIC05304B

Fresino WC011A
Cutter WC011A
Fräser WC011A
Fraise WC011A
Fresa WC011A

STANDARD

OPZ09734B

Morsetto A/C - 997
Jaw A/C - 997
Spannbacke A/C - 997
Étau A/C - 997
Mordaza A/C - 997

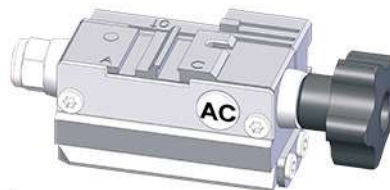

NINJA LASER

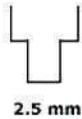

2.5 mm



RIC05304B

Fresino WC011A
Cutter WC011A
Fräser WC011A
Fraise WC011A
Fresa WC011A

STANDARD
(VERSION 4 JAWS)



2.5 mm



RIC05048B
Fresino V003
Cutter V003
Fräser V003
Fraise V003
Fresa V003

OPZ04875B

Morsetto A03
Jaw A03
Spannbacke A03
Étau A03
Mordaza A03

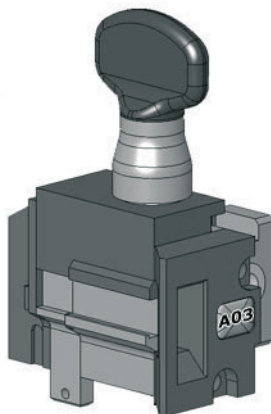

NINJA TOTAL



NINJA VORTEX



VERSA

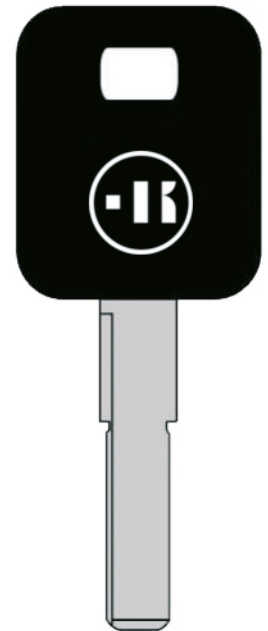

AD66TK1

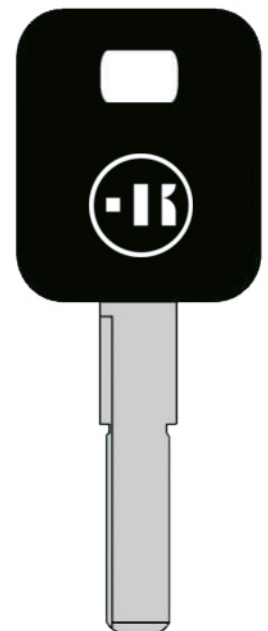

AD66TK8

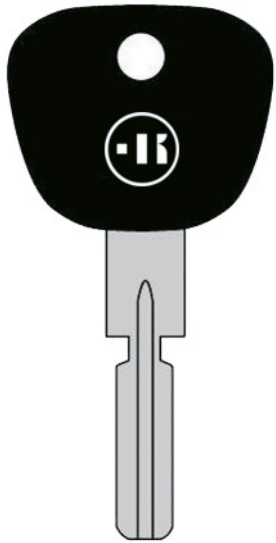

HU58P



303/304/305

**T-REX
T-REX ADVANCE**

PUNTO

STANDARD



2.5 mm

RIC01810B
Fresino HC011
Cutter HC011
Fräser HC011
Fraise HC011
Fresa HC011



RIC01811B
Tastatore C011
Tracer Point C011
Taster C011
Palpeur C011
Palpador C011



994 LASER

STANDARD

OPZ03183B
Morsetto B-994
Jaw B-994
Spannbacke B-994
Étau B-994
Mordaza B-994



2.5 mm



RIC05304B
Fresino WC011A
Cutter WC011A
Fräser WC011A
Fraise WC011A
Fresa WC011A



NINJA LASER

STANDARD

OPZ09781B
Morsetto B - 997
Jaw B - 997
Spannbacke B - 997
Étau B - 997
Mordaza B - 997



2.5 mm



RIC05304B
Fresino WC011A
Cutter WC011A
Fräser WC011A
Fraise WC011A
Fresa WC011A

STANDARD
(VERSION 4 JAWS)



2.5 mm



RIC05048B
Fresino V003
Cutter V003
Fräser V003
Fraise V003
Fresa V003

OPZ04873B
Morsetto A02
Jaw A02
Spannbacke A02
Étau A02
Mordaza A02

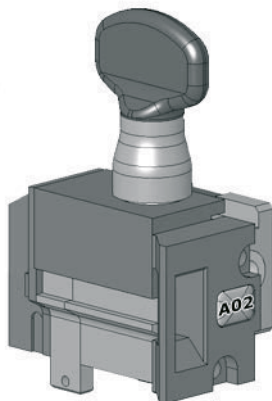

NINJA TOTAL



NINJA VORTEX



VERSA

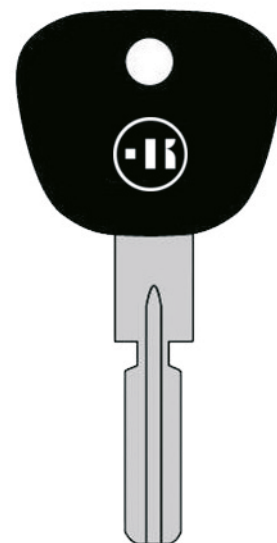

HU58P



BM9U



OPTIONAL



2 mm

RIC01816B
Fresino HC044
Cutter HC044
Fräser HC044
Fraise HC044
Fresa HC044



RIC01817B
Tastatore C044
Tracer Point C044
Taster C044
Palpeur C044
Palpador C044



OPZ09329B
Adattatore AV08
Adaptor AV08
Adapter AV08
Adaptateur AV08
Adaptador AV08
OPTIONAL

OPZ03182B
Morsetto A-994
Jaw A-994
Spannbacke A-994
Étau A-994
Mordaza A-994
STANDARD

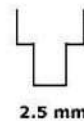

2.5 mm

RIC05304B
Fresino WC011A
Cutter WC011A
Fräser WC011A
Fraise WC011A
Fresa WC011A
STANDARD



OPZ09329B
Adattatore AV08
Adaptor AV08
Adapter AV08
Adaptateur AV08
Adaptador AV08
OPTIONAL

OPZ09734B
Morsetto A/C - 997
Jaw A/C - 997
Spannbacke A/C - 997
Étau A/C - 997
Mordaza A/C - 997
STANDARD

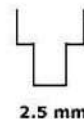
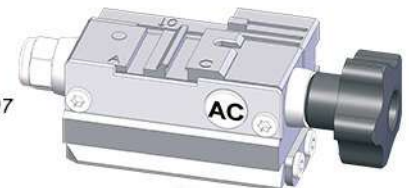

2.5 mm

RIC05304B
Fresino WC011A
Cutter WC011A
Fräser WC011A
Fraise WC011A
Fresa WC011A
STANDARD





OPZ09329B
Adattatore AV08
Adaptor AV08
Adapter AV08
Adaptateur AV08
Adaptador AV08
OPTIONAL



OPZ04871B
Morsetto A01
Jaw A01
Spannbacke A01
Étau A01
Mordaza A01
STANDARD
(VERSION 4 JAWS)

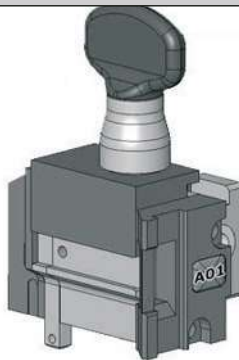

NINJA VORTEX



VERSA



OPZ09329B
Adattatore AV08
Adaptor AV08
Adapter AV08
Adaptateur AV08
Adaptador AV08
OPTIONAL



OPZ10569B
Morsetto C30
Jaw C30
Spannbacke C30
Étau C30
Mordaza C30
STANDARD

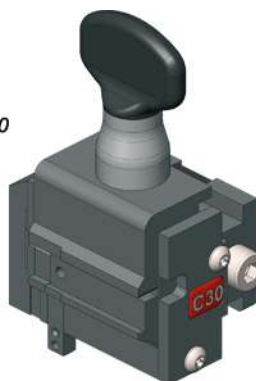

NINJA TOTAL

BM9U



BM2TK



303/304/305

**T-REX
T-REX ADVANCE**

PUNTO



994 LASER



NINJA LASER

OPTIONAL



3,0 mm

RIC01715B
Fresino HC030
Cutter HC030
Fräser HC030
Fraise HC030
Fresa HC030



RIC01716B
Tastatore C030
Tracer Point C030
Taster C030
Palpeur C030
Palpador C030

STANDARD

OPZ05223B
Morsetto C-994
Jaw C-994
Spannbacke C-994
Étau C-994
Mordaza C-994



2.5 mm



RIC05304B
Fresino WC011A
Cutter WC011A
Fräser WC011A
Fraise WC011A
Fresa WC011A

STANDARD

OPZ09734B
Morsetto A/C - 997
Jaw A/C - 997
Spannbacke A/C - 997
Étau A/C - 997
Mordaza A/C - 997

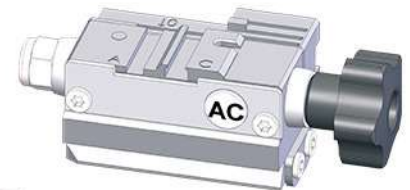

2.5 mm



RIC05304B
Fresino WC011A
Cutter WC011A
Fräser WC011A
Fraise WC011A
Fresa WC011A

STANDARD
(VERSION 4 JAWS)



2.5 mm



RIC05048B
Fresino V003
Cutter V003
Fräser V003
Fraise V003
Fresa V003

OPZ04875B
Morsetto A03
Jaw A03
Spannbacke A03
Étau A03
Mordaza A03

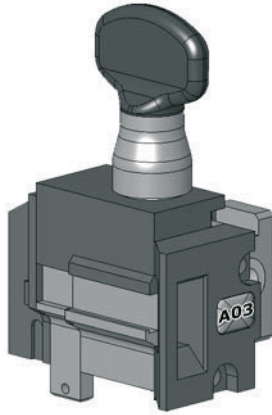

NINJA TOTAL



NINJA VORTEX



VERSA



BM2TK



CARAT/106



**101/102
103/104**



**EURO/ECO
EASY/LUPO**

OPTIONAL

MC

*Adattatori per chiavi Simplex
Adaptors for Simplex keys
Adapters für Simplex-Schlüssel
Adaptateurs pour clés Simplex
Adaptadores para llaves Simplex*



994 LASER

OPTIONAL

OPZ09733B

*Morsetto S per chiavi Simplex
Jaw S for Simplex keys
Spannbacke S für Simplex-Schlüssel
Étau S pour clés Simplex
Mordaza S para llaves Simplex*

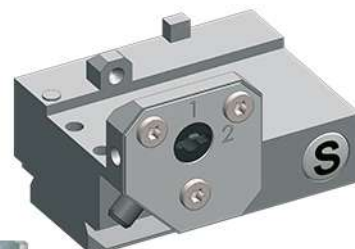

RIC08409B

*Fresino CL004
Cutter CL004
Fräser CL004
Fraise CL004
Fresa CL004*



1,5 mm



INCLUDED WITH JAW

*Tastatore TL002
Tracer Point TL002
Taster TL002
Palpeur TL002
Palpador TL002*



**CN22AP
CN22CP
CN22U
CN22TK1
CN22TK8**

OPTIONAL



OPZ08264B
Adattatore B6 per chiavi Simplex
Adaptor B6 sides for Simplex keys
Adapter B6 für Simplex Schlüssel
Adaptateur B6 pour clés Simplex
Adaptador B6 para llaves Simplex



DEZMO



NINJA LASER



NINJA TOTAL



CN22AP
CN22CP
CN22U
CN22TK1
CN22TK8



FT22TK



303/304/305



T-REX
T-REX ADVANCE



PUNTO



994 LASER



NINJA LASER

OPTIONAL



2 mm

RIC01816B
Fresino HC044
Cutter HC044
Fräser HC044
Fraise HC044
Fresa HC044



RIC01817B
Tastatore C044
Tracer Point C044
Taster C044
Palpeur C044
Palpador C044

STANDARD

OPZ05223B
Morsetto C-994
Jaw C-994
Spannbacke C-994
Étau C-994
Mordaza C-994



2.5 mm



RIC05304B
Fresino WC011A
Cutter WC011A
Fräser WC011A
Fraise WC011A
Fresa WC011A

STANDARD

OPZ09734B
Morsetto A/C - 997
Jaw A/C - 997
Spannbacke A/C - 997
Étau A/C - 997
Mordaza A/C - 997

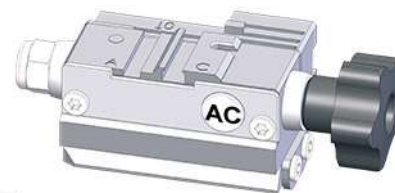

2.5 mm



RIC05304B
Fresino WC011A
Cutter WC011A
Fräser WC011A
Fraise WC011A
Fresa WC011A

STANDARD
(VERSION 4 JAWS)



2.5 mm



RIC05048B
Fresino V003
Cutter V003
Fräser V003
Fraise V003
Fresa V003

OPZ04875B
Morsetto A03
Jaw A03
Spannbacke A03
Étau A03
Mordaza A03

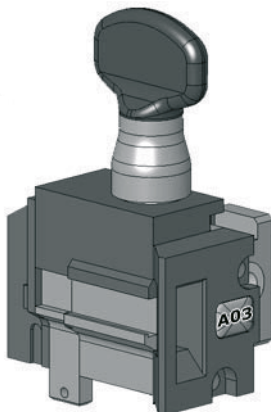

NINJA TOTAL



NINJA VORTEX



VERSA



FT22TK



CARAT/106



**101/102
103/104**



**EURO/ECO
EASY/LUPO**

OPTIONAL

MC

*Adattatori per chiavi Simplex
Adaptors for Simplex keys
Adapters für Simplex-Schlüssel
Adaptateurs pour clés Simplex
Adaptadores para llaves Simplex*



994 LASER

OPTIONAL

OPZ09733B

*Morsetto S per chiavi Simplex
Jaw S for Simplex keys
Spannbacke S für Simplex-Schlüssel
Étau S pour clés Simplex
Mordaza S para llaves Simplex*

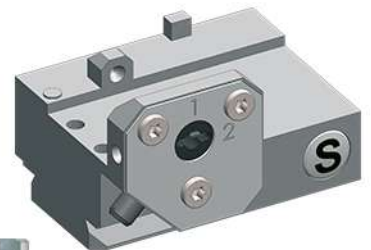

RIC08409B

*Fresino CL004
Cutter CL004
Fräser CL004
Fraise CL004
Fresa CL004*



1,5 mm



INCLUDED WITH JAW

*Tastatore TL002
Tracer Point TL002
Taster TL002
Palpeur TL002
Palpador TL002*



**CN22AP
CN22CP
CN22U
CN22TK1
CN22TK8**

OPTIONAL



OPZ08264B
Adattatore B6 per chiavi Simplex
Adaptor B6 sides for Simplex keys
Adapter B6 für Simplex Schlüssel
Adaptateur B6 pour clés Simplex
Adaptador B6 para llaves Simplex



DEZMO



NINJA LASER



NINJA TOTAL



CN22AP
CN22CP
CN22U
CN22TK1
CN22TK8

TO FIT: FORD (EU)

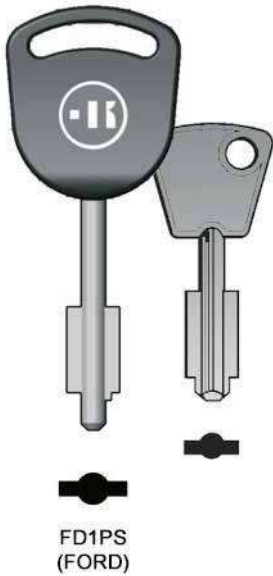

OPTIONAL

OPZ06365B
 Morsetti per chiavi CHUBB
 Jaws for CHUBB keys
 Spannbacken für CHUBB
 Étaux pour clés CHUBB
 Mordazas para CHUBB

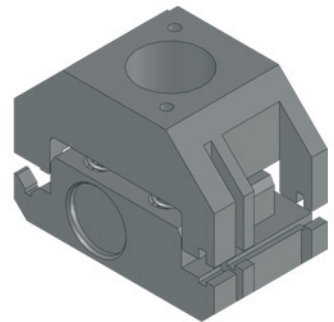

TO FIT: FORD (EU)

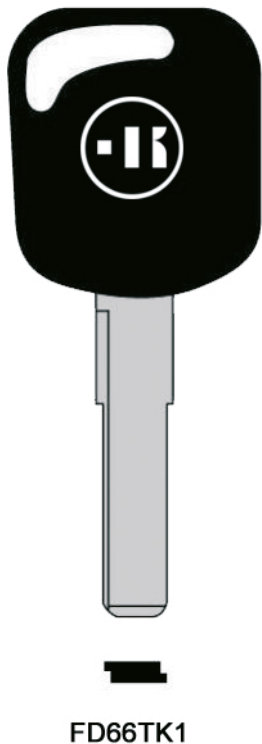

OPTIONAL

MA
 Adattatori per chiavi VAG
 Adaptors for VAG keys
 Adapter für VAG-Schlüssel
 Adaptateurs pour clés VAG
 Adaptadores para llaves VAG



STANDARD



RIC01810B
 Fresino HC011
 Cutter HC011
 Fräser HC011
 Fraise HC011
 Fresa HC011



RIC01811B
 Tastatore C011
 Tracer Point C011
 Taster C011
 Palpeur C011
 Palpador C011

OPTIONAL

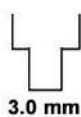

RIC01715B
 Fresino HC030
 Cutter HC030
 Fräser HC030
 Fraise HC030
 Fresa HC030



RIC01716B
 Tastatore C030
 Tracer Point C030
 Taster C030
 Palpeur C030
 Palpador C030

STANDARD



2,5 mm

RIC01810B
Fresino HC011
Cutter HC011
Fräser HC011
Fraise HC011
Fresa HC011



RIC01811B
Tastatore C011
Tracer Point C011
Taster C011
Palpeur C011
Palpador C011



**T-REX
T-REX ADVANCE**

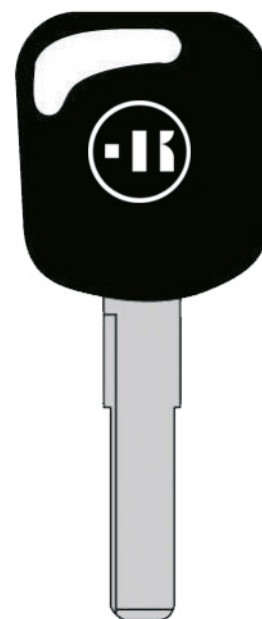

FD66TK1

OPTIONAL



3,0 mm

RIC01715B
Fresino HC030
Cutter HC030
Fräser HC030
Fraise HC030
Fresa HC030



RIC01716B
Tastatore C030
Tracer Point C030
Taster C030
Palpeur C030
Palpador C030

STANDARD

OPZ05223B
Morsetto C-994
Jaw C-994
Spannbacke C-994
Étau C-994
Mordaza C-994

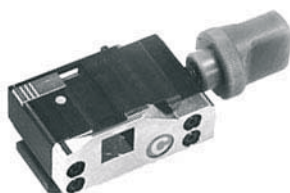

994 LASER



2.5 mm



RIC05304B
Fresino WC011A
Cutter WC011A
Fräser WC011A
Fraise WC011A
Fresa WC011A

STANDARD

OPZ09734B
Morsetto A/C - 997
Jaw A/C - 997
Spannbacke A/C - 997
Étau A/C - 997
Mordaza A/C - 997

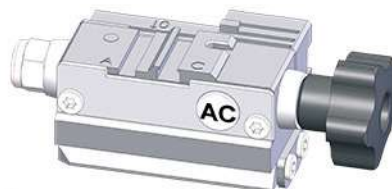

NINJA LASER



2.5 mm



RIC05304B
Fresino WC011A
Cutter WC011A
Fräser WC011A
Fraise WC011A
Fresa WC011A

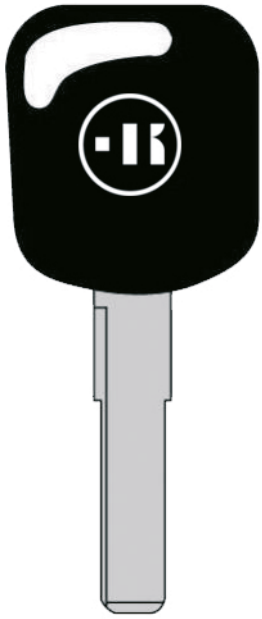

FD66TK1



NINJA TOTAL



NINJA VORTEX



VERSA

STANDARD
(VERSION 4 JAWS)



2.5 mm



RIC05048B
Fresino V003
Cutter V003
Fräser V003
Fraise V003
Fresa V003

OPZ04875B
Morsetto A03
Jaw A03
Spannbacke A03
Étau A03
Mordaza A03

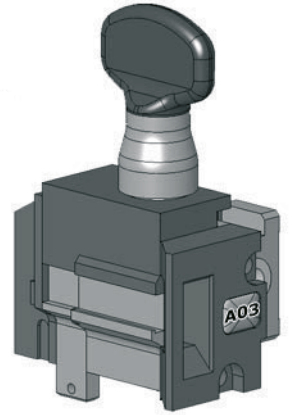

TO
FIT :

FORD (EU) - FORD (USA)

OPTIONAL

MTB
Dispositivo a codice
Code adaptor
Code-Vorrichtung
Dispositif à code
Dispositivo a código

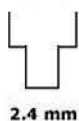

2.4 mm

RIC01808B
Fresino HC208
Cutter HC208
Fräser HC208
Fraise HC208
Fresa HC208



RIC01809B
Tastatore C208
Tracer Point C208
Taster C208
Palpeur C208
Palpador C208



303/304/305



**T-REX
T-REX ADVANCE**



PUNTO



OPTIONAL

CSR
Carrello per chiavi Tibbe
Carriage for Tibbe keys
Schlitten für Tibbe-Schlüssel
Chariot pour clés Tibbe
Carro las llaves de Tibbe

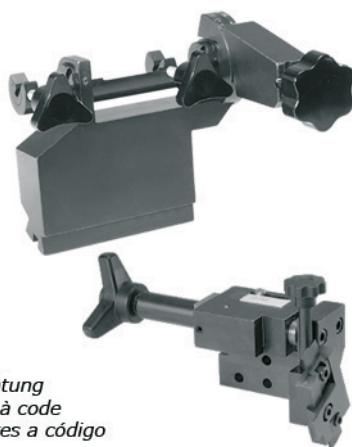

T3PCOD
Tastatore 3 posizioni a codice
3 position code cutting tracer
3 Positions-Taster mit Kodevorrichtung
Palpeur 3 positions avec dispositif à code
Palpador 3 posiciones para los cortes a código

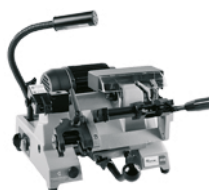

202



203



OPTIONAL

OPZ05031B
Morsetto 05 per chiavi Tibbe
Jaw 05 for Tibbe keys
Spannbacke 05 für Tibbe-Schlüssel
Étau 05 pour clés Tibbe
Mordaza 05 para llaves Tibbe

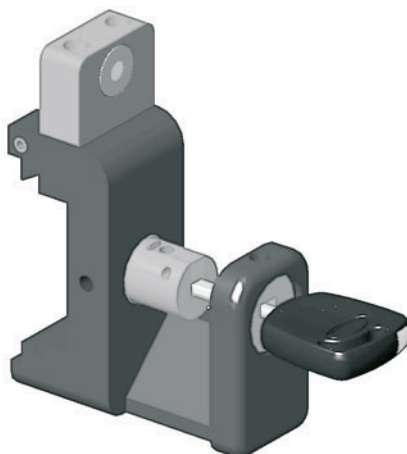

**POWER LYNX
SIGMA PRO**

**FD3AP
FD3P
FD3TK14
FD3TK23
FD3TK2
FD3TK7
FD3U**



FALCON

OPTIONAL



OPZ08657B
 Morsetto 01 per chiavi Tibbe
 Jaw 01 for Tibbe keys
 Spannbacke 01 für Tibbe Schlüssel
 Étau 01 pour clés Tibbe
 Mordaza 01 para llaves Tibbe



NINJA LASER

OPTIONAL

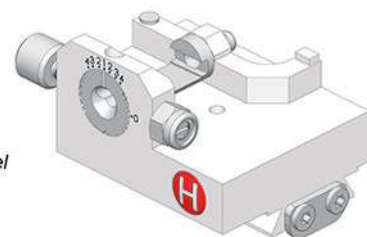

OPZ09523B
 Morsetto H per chiavi Tibbe
 Jaw H for Tibbe keys
 Spannbacke H für Tibbe-Schlüssel
 Étau H pour clés Tibbe
 Mordaza H para llaves Tibbe



994 LASER

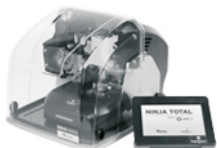

NINJA TOTAL



NINJA VORTEX



RIC05048B
 Fresino V003
 Cutter V003
 Fräser V003
 Fraise V003
 Fresa V003
STANDARD
 (VERSION 4 JAWS)

OPZ10588B
 Morsetto C41
 Jaw C41
 Spannbacke C41
 Étau C41
 Mordaza C41
OPTIONAL



- FD3AP
- FD3P
- FD3TK14
- FD3TK23
- FD3TK2
- FD3TK7
- FD3U



VERSA

TO
FIT :

FORD (EU) - FORD (USA)

STANDARD

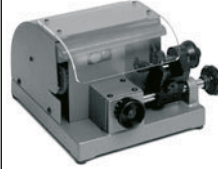

FOCUS



FD3AP
FD3P
FD3TK14
FD3TK23
FD3TK2
FD3TK7
FD3U



FD40BTK



303/304/305
T-REX
T-REX ADVANCE
PUNTO

OPTIONAL

MOMAX

*Adattatori per chiavi Opel e Ford C-MAX
Adaptors for Opel and Ford C-MAX keys
Adaptors für Opel und Ford C-MAX-Schlüssel
Adaptateurs pour clés Opel et Ford C-MAX
Adaptadores para llaves Opel y Ford C-MAX*



STANDARD

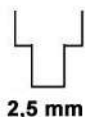

2,5 mm

RIC01810B

*Fresino HC011
Cutter HC011
Fräser HC011
Fraise HC011
Fresa HC011*



RIC01811B

*Tastatore C011
Tracer Point C011
Taster C011
Palpeur C011
Palpador C011*

OPTIONAL



3,0 mm

RIC01715B

*Fresino HC030
Cutter HC030
Fräser HC030
Fraise HC030
Fresa HC030*



RIC01716B

*Tastatore C030
Tracer Point C030
Taster C030
Palpeur C030
Palpador C030*



FD40AP



994 LASER

STANDARD

OPZ03182B

*Morsetto A-994
Jaw A-994
Spannbacke A-994
Étau A-994
Mordaza A-994*

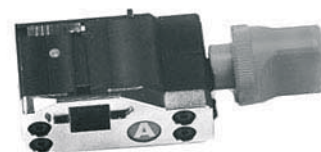

2.5 mm



RIC05304B

*Fresino WC011A
Cutter WC011A
Fräser WC011A
Fraise WC011A
Fresa WC011A*



NINJA LASER

STANDARD

OPZ09734B

*Morsetto A/C - 997
Jaw A/C - 997
Spannbacke A/C - 997
Étau A/C - 997
Mordaza A/C - 997*

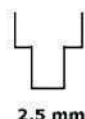
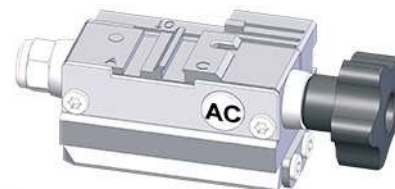

2.5 mm



RIC05304B

*Fresino WC011A
Cutter WC011A
Fräser WC011A
Fraise WC011A
Fresa WC011A*

STANDARD
(VERSION 4 JAWS)



2.5 mm



RIC05048B
Fresino V003
Cutter V003
Fräser V003
Fraise V003
Fresa V003

OPZ04871B
Morsetto A01
Jaw A01
Spannbacke A01
Étau A01
Mordaza A01

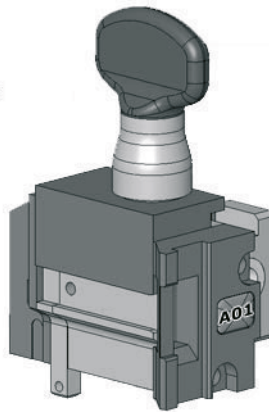

NINJA VORTEX



VERSA



FD40BTK



2.5 mm



RIC05048B
Fresino V003
Cutter V003
Fräser V003
Fraise V003
Fresa V003
STANDARD

OPZ10569B
Morsetto C30
Jaw C30
Spannbacke C30
Étau C30
Mordaza C30
STANDARD



NINJA TOTAL

OPZ10582B
Adattatore AV12 per chiavi Huf
Adaptor AV12 for Huf keys
Adapter AV12 für Huf-Schlüssel
Adaptateur AV12 pour clés Huf
Adaptador AV12 para llaves Huf
OPTIONAL



FD40AP

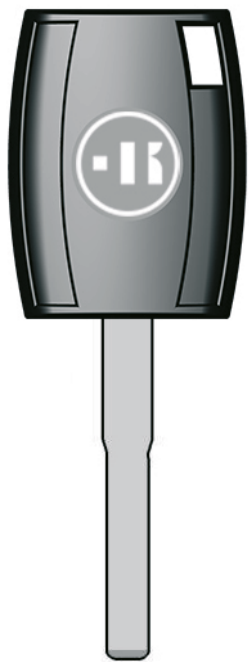

FD40BTK



994 LASER

OPZ03182B
 Morsetto A-994
 Jaw A-994
 Spannbacke A-994
 Étau A-994
 Mordaza A-994
STANDARD



RIC09617B
 Fresino CL005
 Cutter CL005
 Fräser CL005
 Fraise CL005
 Fresa CL005
OPTIONAL



1,5 mm



NINJA LASER

OPZ09734B
 Morsetto A/C - 997
 Jaw A/C - 997
 Spannbacke A/C - 997
 Étau A/C - 997
 Mordaza A/C - 997
STANDARD

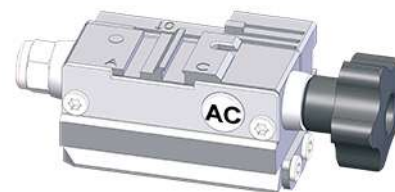

RIC09617B
 Fresino CL005
 Cutter CL005
 Fräser CL005
 Fraise CL005
 Fresa CL005
OPTIONAL



1,5 mm



FD40AP



NINJA VORTEX



1.5 mm



VERSA



RIC05274B
 Fresino V012
 Cutter V012
 Fräser V012
 Fraise V012
 Fresa V012
OPTIONAL

OPZ04871B
 Morsetto A01
 Jaw A01
 Spannbacke A01
 Étau A01
 Mordaza A01
STANDARD
 (VERSION 4 JAWS)

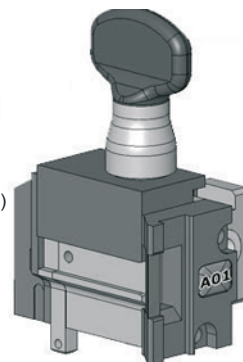



1.5 mm



RIC05274B

Fresino V012
Cutter V012
Fräser V012
Fraise V012
Fresa V012

OPTIONAL



OPZ10569B
Morsetto C30
Jaw C30
Spannbacke C30
Étau C30
Mordaza C30
STANDARD

OPZ10582B

Adattatore AV12 per chiavi Huf
Adaptor AV12 for Huf keys
Adapter AV12 für Huf-Schlüssel
Adaptateur AV12 pour clés Huf
Adaptador AV12 para llaves Huf

OPTIONAL



NINJA TOTAL



FD40BTK



FD40AP



STANDARD



2,5 mm

RIC01810B
Fresino HC011
Cutter HC011
Fräser HC011
Fraise HC011
Fresa HC011

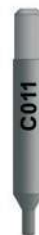

RIC01811B
Tastatore C011
Tracer Point C011
Taster C011
Palpeur C011
Palpador C011

OPTIONAL



2,0 mm

RIC01816B
Fresino HC044
Cutter HC044
Fräser HC044
Fraise HC044
Fresa HC044



RIC01817B
Tastatore C044
Tracer Point C044
Taster C044
Palpeur C044
Palpador C044



STANDARD

OPZ03182B
Morsetto A-994
Jaw A-994
Spannbacke A-994
Étau A-994
Mordaza A-994

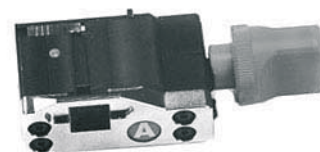

2.5 mm



RIC05304B
Fresino WC011A
Cutter WC011A
Fräser WC011A
Fraise WC011A
Fresa WC011A



STANDARD

OPZ09734B
Morsetto A/C - 997
Jaw A/C - 997
Spannbacke A/C - 997
Étau A/C - 997
Mordaza A/C - 997

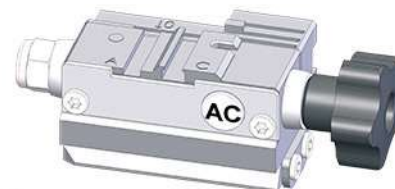

2.5 mm



RIC05304B
Fresino WC011A
Cutter WC011A
Fräser WC011A
Fraise WC011A
Fresa WC011A

STANDARD
(VERSION 4 JAWS)



2.5 mm



RIC05048B
Fresino V003
Cutter V003
Fräser V003
Fraise V003
Fresa V003

OPZ04875B
Morsetto A03
Jaw A03
Spannbacke A03
Étau A03
Mordaza A03

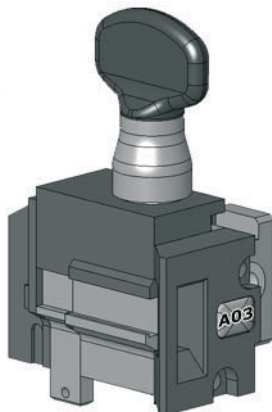

NINJA TOTAL



NINJA VORTEX



VERSA





HD1U



HD1BTK
HD1TK5



STANDARD



2.5 mm

RIC01810B
Fresino HC011
Cutter HC011
Fräser HC011
Fraise HC011
Fresa HC011



RIC01811B
Tastatore C011
Tracer Point C011
Taster C011
Palpeur C011
Palpador C011

STANDARD

OPZ03182B
Morsetto A-994
Jaw A-994
Spannbacke A-994
Étau A-994
Mordaza A-994

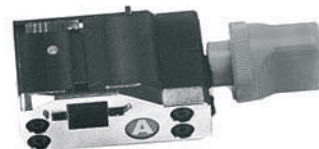

2.5 mm



RIC05304B
Fresino WC011A
Cutter WC011A
Fräser WC011A
Fraise WC011A
Fresa WC011A

STANDARD

OPZ09734B
Morsetto A/C - 997
Jaw A/C - 997
Spannbacke A/C - 997
Étau A/C - 997
Mordaza A/C - 997

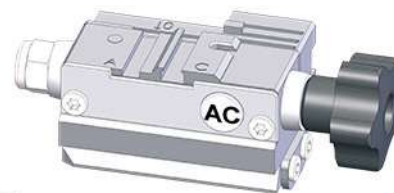

2.5 mm



RIC05304B
Fresino WC011A
Cutter WC011A
Fräser WC011A
Fraise WC011A
Fresa WC011A

TO
FIT :

HONDA (J)

STANDARD
(VERSION 4 JAWS)



2.5 mm



RIC05048B
Fresino V003
Cutter V003
Fräser V003
Fraise V003
Fresa V003

OPZ04871B
Morsetto A01
Jaw A01
Spannbacke A01
Étau A01
Mordaza A01

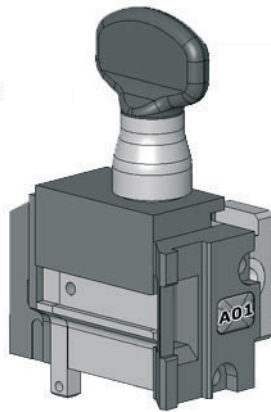

NINJA VORTEX



VERSA



HD1U

STANDARD



2.5 mm



RIC05048B
Fresino V003
Cutter V003
Fräser V003
Fraise V003
Fresa V003

OPZ10569B
Morsetto C30
Jaw C30
Spannbacke C30
Étau C30
Mordaza C30



NINJA TOTAL



HD1BTK
HD1TK5



Acura (J)



303/304/305

**T-REX
T-REX ADVANCE**

PUNTO



994 LASER



NINJA LASER

OPTIONAL



2 mm

RIC01816B
Fresino HC044
Cutter HC044
Fräser HC044
Fraise HC044
Fresa HC044



RIC01817B
Tastatore C044
Tracer Point C044
Taster C044
Palpeur C044
Palpador C044

STANDARD

OPZ03183B
Morsetto B-994
Jaw B-994
Spannbacke B-994
Étau B-994
Mordaza B-994



2.5 mm



RIC05304B
Fresino WC011A
Cutter WC011A
Fräser WC011A
Fraise WC011A
Fresa WC011A

STANDARD

OPZ09781B
Morsetto B - 997
Jaw B - 997
Spannbacke B - 997
Étau B - 997
Mordaza B - 997



2.5 mm



RIC05304B
Fresino WC011A
Cutter WC011A
Fräser WC011A
Fraise WC011A
Fresa WC011A

STANDARD
(VERSION 4 JAWS)



2.5 mm



RIC05048B
Fresino V003
Cutter V003
Fräser V003
Fraise V003
Fresa V003

OPZ04873B
Morsetto A02
Jaw A02
Spannbacke A02
Étau A02
Mordaza A02

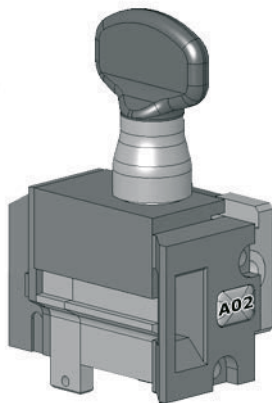

NINJA TOTAL



NINJA VORTEX



VERSA



Acura (J)

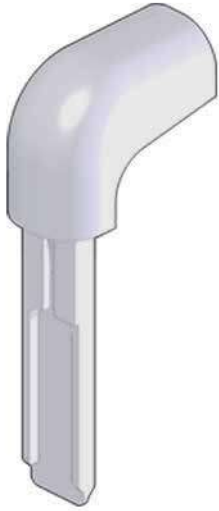

EMERGENCY KEY



994 LASER

OPZ03182B
 Morsetto A-994
 Jaw A-994
 Spannbacke A-994
 Étau A-994
 Mordaza A-994
STANDARD



OPZ05223B
 Morsetto C-994
 Jaw C-994
 Spannbacke C-994
 Étau C-994
 Mordaza C-994
STANDARD



OPZ07885B
 Adattatore AD03 per chiavi Lexus
 Adaptor AD03 for Lexus keys
 Adapter AD03 für Lexus-Schlüssel
 Adaptateur AD03 pour clés Lexus
 Adaptador AD03 para llaves Lexus
OPTIONAL

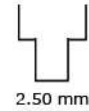

2.50 mm

RIC05304B
 Fresino WC011A
 Cutter WC011A
 Fräser WC011A
 Fraise WC011A
 Fresa WC011A
STANDARD



NINJA LASER

OPZ09734B
 Morsetto A/C - 997
 Jaw A/C - 997
 Spannbacke A/C - 997
 Étau A/C - 997
 Mordaza A/C - 997
STANDARD



OPZ07885B
 Adattatore AD03 per chiavi Lexus
 Adaptor AD03 for Lexus keys
 Adapter AD03 für Lexus-Schlüssel
 Adaptateur AD03 pour clés Lexus
 Adaptador AD03 para llaves Lexus
OPTIONAL

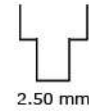
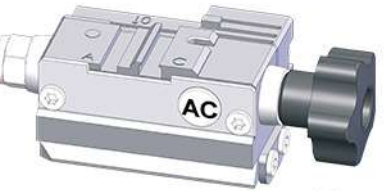

2.50 mm

RIC05304B
 Fresino WC011A
 Cutter WC011A
 Fräser WC011A
 Fraise WC011A
 Fresa WC011A
STANDARD



NINJA VORTEX



OPZ10631B
 Adattatore AD06
 Adaptor AD06
 Adapter AD06
 Adaptateur AD06
 Adaptador AD06
OPTIONAL



RIC05048B
 Fresino V003
 Cutter V003
 Fräser V003
 Fraise V003
 Fresa V003
STANDARD
 (VERSION 4 JAWS)



2.5 mm

OPZ04871B
 Morsetto A01
 Jaw A01
 Spannbacke A01
 Étau A01
 Mordaza A01
STANDARD
 (VERSION 4 JAWS)

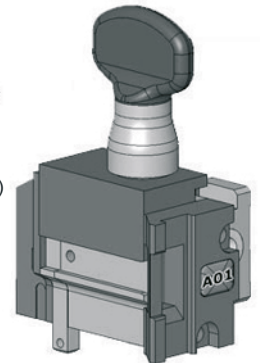

VERSA



NINJA TOTAL



OPZ10631B
 Adattatore AD06
 Adaptor AD06
 Adapter AD06
 Adaptateur AD06
 Adaptador AD06
OPTIONAL



RIC05048B
 Fresino V003
 Cutter V003
 Fräser V003
 Fraise V003
 Fresa V003
STANDARD

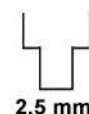

2.5 mm

OPZ10569B
 Morsetto C30
 Jaw C30
 Spannbacke C30
 Étau C30
 Mordaza C30
STANDARD



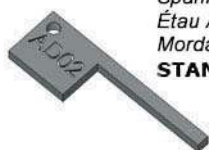

OPZ09734B
 Morsetto A/C - 997
 Jaw A/C - 997
 Spannbacke A/C - 997
 Étau A/C - 997
 Mordaza A/C - 997
STANDARD

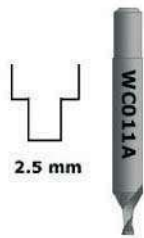
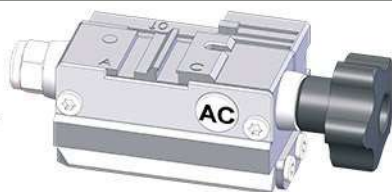

RIC05304B
 Fresino WC011A
 Cutter WC011A
 Fräser WC011A
 Fraise WC011A
 Fresa WC011A
STANDARD

OPZ05406B
 Adattatore AD02 per chiavi Infiniti
 Adaptor AD02 for Infiniti keys
 Adapter AD02 für Infiniti-Schlüssel
 Adaptateur AD02 pour clés Infiniti
 Adaptador AD02 para llaves Infiniti
OPTIONAL



NINJA LASER

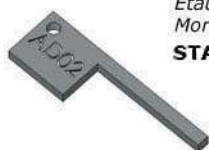

OPZ03182B
 Morsetto A-994
 Jaw A-994
 Spannbacke A-994
 Étau A-994
 Mordaza A-994
STANDARD

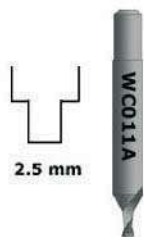

RIC05304B
 Fresino WC011A
 Cutter WC011A
 Fräser WC011A
 Fraise WC011A
 Fresa WC011A
STANDARD

OPZ05406B
 Adattatore AD02 per chiavi Infiniti
 Adaptor AD02 for Infiniti keys
 Adapter AD02 für Infiniti-Schlüssel
 Adaptateur AD02 pour clés Infiniti
 Adaptador AD02 para llaves Infiniti
OPTIONAL



994 LASER



RIC05048B
 Fresino V003
 Cutter V003
 Fräser V003
 Fraise V003
 Fresa V003
STANDARD
 (VERSION 4 JAWS)

OPZ04871B
 Morsetto A01
 Jaw A01
 Spannbacke A01
 Étau A01
 Mordaza A01
STANDARD
 (VERSION 4 JAWS)

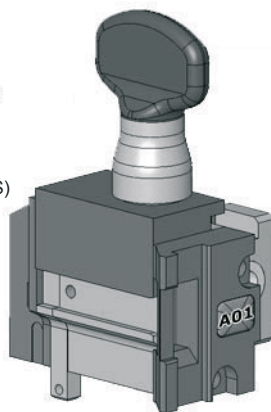

NINJA VORTEX



VERSA



OPZ05493B
 Adattatore AV01 per chiavi Infiniti
 Adaptor AV01 for Infiniti keys
 Adapter AV01 für Infiniti-Schlüssel
 Adaptateur AV01 pour clés Infiniti
 Adaptador AV01 para llaves Infiniti
OPTIONAL



RIC05048B
 Fresino V003
 Cutter V003
 Fräser V003
 Fraise V003
 Fresa V003
STANDARD

OPZ10569B
 Morsetto C30
 Jaw C30
 Spannbacke C30
 Étau C30
 Mordaza C30
STANDARD



NINJA TOTAL

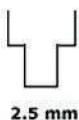

OPZ05493B
 Adattatore AV01 per chiavi Infiniti
 Adaptor AV01 for Infiniti keys
 Adapter AV01 für Infiniti-Schlüssel
 Adaptateur AV01 pour clés Infiniti
 Adaptador AV01 para llaves Infiniti
OPTIONAL

Short Keys



994 LASER



OPZ10269B

*Adattatore AD05 per chiavi Short
Adaptor AD05 for Short keys
Adapter AD05 für Short-Schlüssel
Adaptateur AD05 pour clés Short
Adaptador AD05 para llaves Short*
OPTIONAL

OPZ03185B
*Morsetto D-994
Jaw D-994
Spannbacke D-994
Étau D-994
Mordaza D-994*
STANDARD



2.5 mm



RIC05304B
*Fresino WC011A
Cutter WC011A
Fräser WC011A
Fraise WC011A
Fresa WC011A*
STANDARD



NINJA LASER



OPZ10269B

*Adattatore AD05 per chiavi Short
Adaptor AD05 for Short keys
Adapter AD05 für Short-Schlüssel
Adaptateur AD05 pour clés Short
Adaptador AD05 para llaves Short*
OPTIONAL

OPZ09783B
*Morsetto D - 997
Jaw D - 997
Spannbacke D - 997
Étau D - 997
Mordaza D - 997*
STANDARD

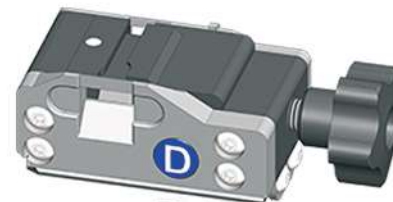

2.5 mm



RIC05304B
*Fresino WC011A
Cutter WC011A
Fräser WC011A
Fraise WC011A
Fresa WC011A*
STANDARD

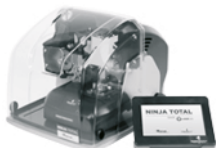

NINJA TOTAL



2.5 mm

OPZ04877B
*Morsetto A04
Jaw A04
Spannbacke A04
Étau A04
Mordaza A04*
OPTIONAL



NINJA VORTEX



RIC05048B
*Fresino V003
Cutter V003
Fräser V003
Fraise V003
Fresa V003*
STANDARD
(VERSION 4 JAWS)

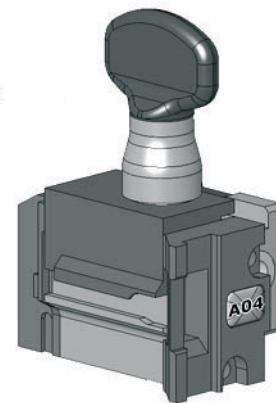

OPTIONAL

OPZ05031B

*Morsetto 05 per chiavi Tibbe
Jaw 05 for Tibbe keys
Spannbacke 05 für Tibbe-Schlüssel
Étau 05 pour clés Tibbe
Mordaza 05 para llaves Tibbe*

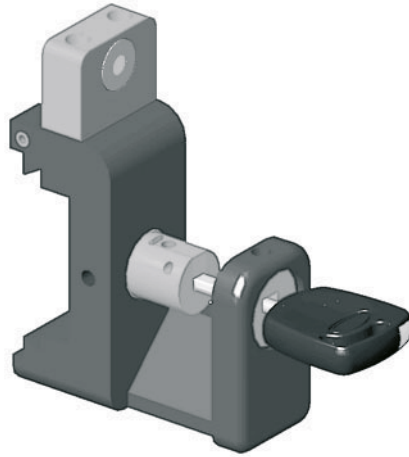

**POWER LYNX
SIGMA PRO**



OPTIONAL

OPZ08657B

*Morsetto 01 per chiavi Tibbe
Jaw 01 for Tibbe keys
Spannbacke 01 für Tibbe Schlüssel
Étau 01 pour clés Tibbe
Mordaza 01 para llaves Tibbe*



FALCON





CARAT/106



**101/102
103/104**



**EURO/ECO
EASY/LUPO**

OPTIONAL

MC

*Adattatori per chiavi Simplex
Adaptors for Simplex keys
Adapters für Simplex-Schlüssel
Adaptateurs pour clés Simplex
Adaptadores para llaves Simplex*



994 LASER

OPTIONAL

OPZ09733B

*Morsetto S per chiavi Simplex
Jaw S for Simplex keys
Spannbacke S für Simplex-Schlüssel
Étau S pour clés Simplex
Mordaza S para llaves Simplex*

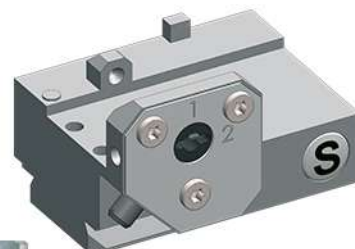

RIC08409B

*Fresino CL004
Cutter CL004
Fräser CL004
Fraise CL004
Fresa CL004*



1,5 mm



INCLUDED WITH JAW

*Tastatore TL002
Tracer Point TL002
Taster TL002
Palpeur TL002
Palpador TL002*



**CN22AP
CN22CP
CN22U
CN22TK1
CN22TK8**

OPTIONAL



OPZ08264B
Adattatore B6 per chiavi Simplex
Adaptor B6 sides for Simplex keys
Adapter B6 für Simplex Schlüssel
Adaptateur B6 pour clés Simplex
Adaptador B6 para llaves Simplex



DEZMO



NINJA LASER



NINJA TOTAL



CN22AP
CN22CP
CN22U
CN22TK1
CN22TK8

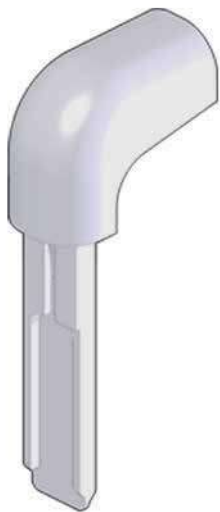

EMERGENCY KEY



994 LASER

OPZ03182B
 Morsetto A-994
 Jaw A-994
 Spannbacke A-994
 Étau A-994
 Mordaza A-994
STANDARD



OPZ05223B
 Morsetto C-994
 Jaw C-994
 Spannbacke C-994
 Étau C-994
 Mordaza C-994
STANDARD



OPZ07885B
 Adattatore AD03 per chiavi Lexus
 Adaptor AD03 for Lexus keys
 Adapter AD03 für Lexus-Schlüssel
 Adaptateur AD03 pour clés Lexus
 Adaptador AD03 para llaves Lexus
OPTIONAL



RIC05304B
 Fresino WC011A
 Cutter WC011A
 Fräser WC011A
 Fraise WC011A
 Fresa WC011A
STANDARD



NINJA LASER

OPZ09734B
 Morsetto A/C - 997
 Jaw A/C - 997
 Spannbacke A/C - 997
 Étau A/C - 997
 Mordaza A/C - 997
STANDARD



OPZ07885B
 Adattatore AD03 per chiavi Lexus
 Adaptor AD03 for Lexus keys
 Adapter AD03 für Lexus-Schlüssel
 Adaptateur AD03 pour clés Lexus
 Adaptador AD03 para llaves Lexus
OPTIONAL

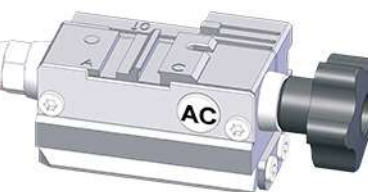

RIC05304B
 Fresino WC011A
 Cutter WC011A
 Fräser WC011A
 Fraise WC011A
 Fresa WC011A
STANDARD



NINJA VORTEX



OPZ10631B
 Adattatore AD06
 Adaptor AD06
 Adapter AD06
 Adaptateur AD06
 Adaptador AD06
OPTIONAL



RIC05048B
 Fresino V003
 Cutter V003
 Fräser V003
 Fraise V003
 Fresa V003
STANDARD
 (VERSION 4 JAWS)



OPZ04871B
 Morsetto A01
 Jaw A01
 Spannbacke A01
 Étau A01
 Mordaza A01
STANDARD
 (VERSION 4 JAWS)

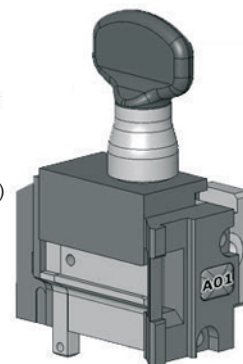

VERSA



NINJA TOTAL



OPZ10631B
 Adattatore AD06
 Adaptor AD06
 Adapter AD06
 Adaptateur AD06
 Adaptador AD06
OPTIONAL



RIC05048B
 Fresino V003
 Cutter V003
 Fräser V003
 Fraise V003
 Fresa V003
STANDARD

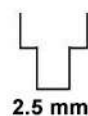

OPZ10569B
 Morsetto C30
 Jaw C30
 Spannbacke C30
 Étau C30
 Mordaza C30
STANDARD



STANDARD



2.5 mm

RIC01810B
Fresino HC011
Cutter HC011
Fräser HC011
Fraise HC011
Fresa HC011



RIC01811B
Tastatore C011
Tracer Point C011
Taster C011
Palpeur C011
Palpador C011



303/304/305



**T-REX
T-REX ADVANCE**



PUNTO



STANDARD

OPZ03182B
Morsetto A-994
Jaw A-994
Spannbacke A-994
Étau A-994
Mordaza A-994



994 LASER

TR49TK



2.5 mm



RIC05304B
Fresino WC011A
Cutter WC011A
Fräser WC011A
Fraise WC011A
Fresa WC011A

STANDARD

OPZ09734B
Morsetto A/C - 997
Jaw A/C - 997
Spannbacke A/C - 997
Étau A/C - 997
Mordaza A/C - 997

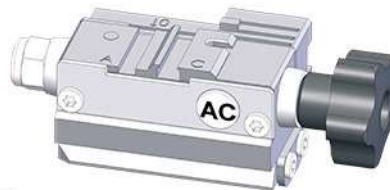

NINJA LASER



2.5 mm



RIC05304B
Fresino WC011A
Cutter WC011A
Fräser WC011A
Fraise WC011A
Fresa WC011A



TR49TK



NINJA VORTEX



VERSA



NINJA TOTAL

STANDARD
(VERSION 4 JAWS)



2.5 mm



RIC05048B
Fresino V003
Cutter V003
Fräser V003
Fraise V003
Fresa V003

OPZ04871B
Morsetto A01
Jaw A01
Spannbacke A01
Étau A01
Mordaza A01

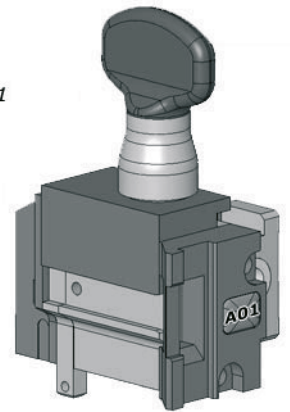

STANDARD



2.5 mm



RIC05048B
Fresino V003
Cutter V003
Fräser V003
Fraise V003
Fresa V003

OPZ10569B
Morsetto C30
Jaw C30
Spannbacke C30
Étau C30
Mordaza C30



STANDARD



2.5 mm

RIC01810B
Fresino HC011
Cutter HC011
Fräser HC011
Fraise HC011
Fresa HC011



RIC01811B
Tastatore C011
Tracer Point C011
Taster C011
Palpeur C011
Palpador C011



303/304/305



**T-REX
T-REX ADVANCE**



PUNTO

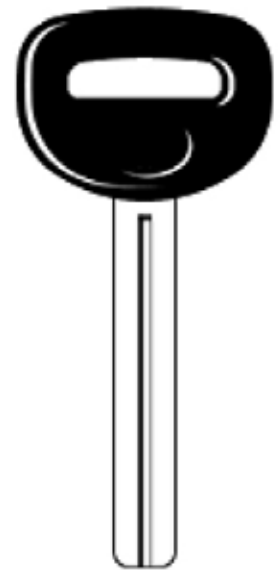

STANDARD

OPZ03182B
Morsetto A-994
Jaw A-994
Spannbacke A-994
Étau A-994
Mordaza A-994



994 LASER



2.5 mm



RIC05304B
Fresino WC011A
Cutter WC011A
Fräser WC011A
Fraise WC011A
Fresa WC011A

STANDARD

OPZ09734B
Morsetto A/C - 997
Jaw A/C - 997
Spannbacke A/C - 997
Étau A/C - 997
Mordaza A/C - 997

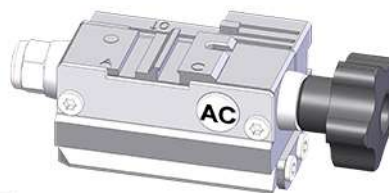

NINJA LASER



2.5 mm



RIC05304B
Fresino WC011A
Cutter WC011A
Fräser WC011A
Fraise WC011A
Fresa WC011A

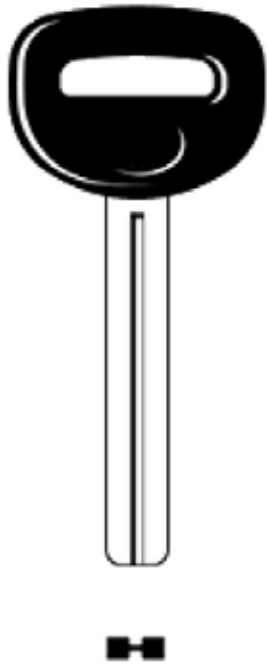

NINJA VORTEX



VERSA



NINJA TOTAL

STANDARD
(VERSION 4 JAWS)



2.5 mm



RIC05048B
Fresino V003
Cutter V003
Fräser V003
Fraise V003
Fresa V003

OPZ04871B
Morsetto A01
Jaw A01
Spannbacke A01
Étau A01
Mordaza A01

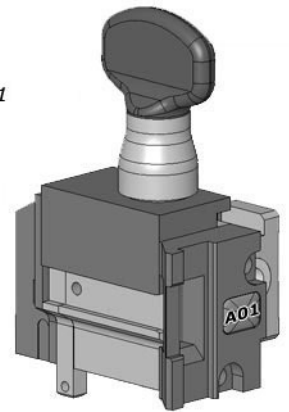

STANDARD



2.5 mm



RIC05048B
Fresino V003
Cutter V003
Fräser V003
Fraise V003
Fresa V003

OPZ10569B
Morsetto C30
Jaw C30
Spannbacke C30
Étau C30
Mordaza C30

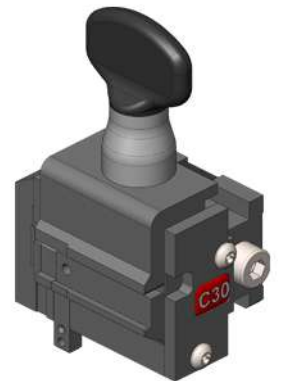

TO
FIT :

MERCEDES (D)

OPTIONAL

MM
Morsetti per chiavi Mercedes
Jaws for Mercedes keys
Spannbacken für Mercedes-Schlüssel
Étaux pour clés Mercedes
Mordazas para llaves Mercedes



STANDARD

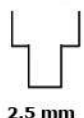

2.5 mm

RIC01810B
Fresino HC011
Cutter HC011
Fräser HC011
Fraise HC011
Fresa HC011



RIC01811B
Tastatore C011
Tracer Point C011
Taster C011
Palpeur C011
Palpador C011



303/304/305



**T-REX
T-REX ADVANCE**



PUNTO

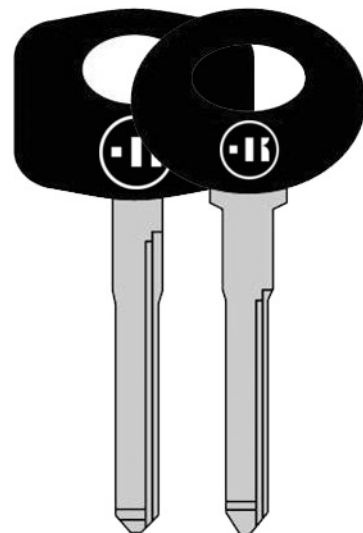

MB57P



MB54P



MB41P

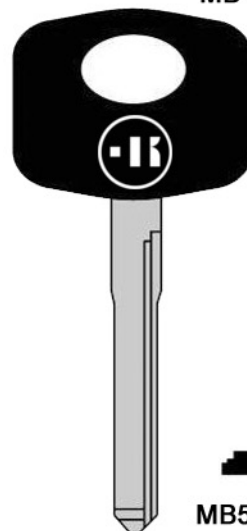

MB56P

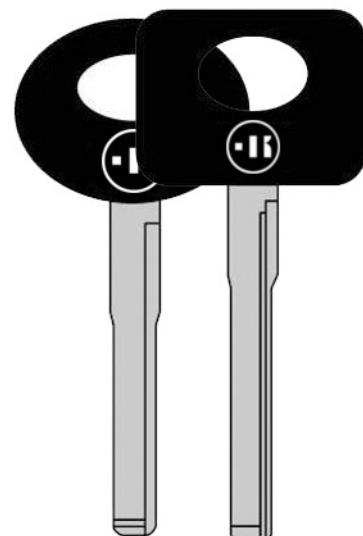

MB58P



MB55P



MB59P

STANDARD

OPZ03185B
Morsetto D-994
Jaw D-994
Spannbacke D-994
Étau D-994
Mordaza D-994

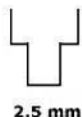

2.5 mm



RIC05304B
Fresino WC011A
Cutter WC011A
Fräser WC011A
Fraise WC011A
Fresa WC011A



994 LASER

STANDARD

OPZ09783B
Morsetto D - 997
Jaw D - 997
Spannbacke D - 997
Étau D - 997
Mordaza D - 997

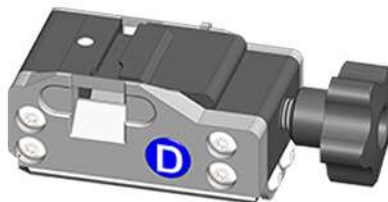

2.5 mm



RIC05304B
Fresino WC011A
Cutter WC011A
Fräser WC011A
Fraise WC011A
Fresa WC011A



NINJA LASER

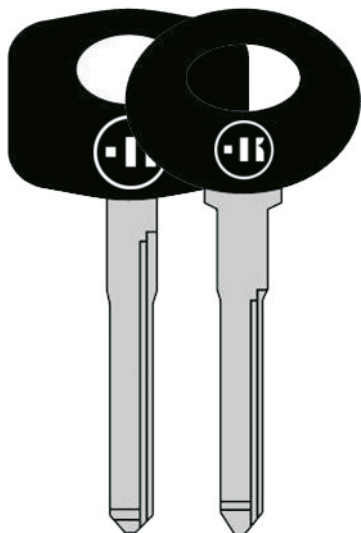

MB57P MB54P
MB41P

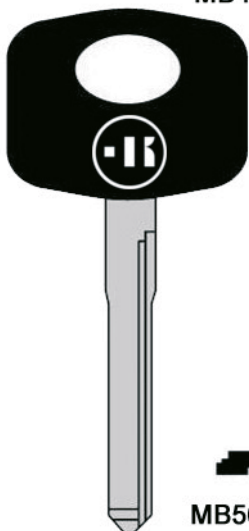

MB56P

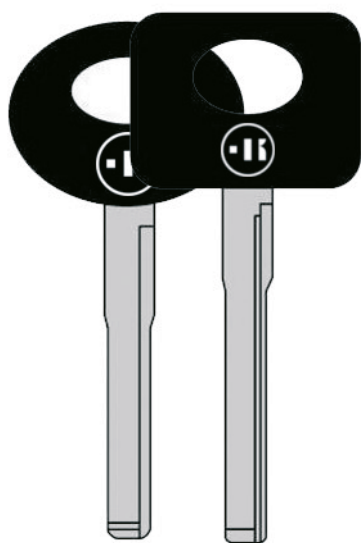

MB58P MB55P
MB59P



NINJA TOTAL



NINJA VORTEX



VERSA



2.5 mm



RIC05048B
Fresino V003
Cutter V003
Fräser V003
Fraise V003
Fresa V003

STANDARD
(VERSION 4 JAWS)

OPZ04877B
Morsetto A04
Jaw A04
Spannbacke A04
Étau A04
Mordaza A04
OPTIONAL

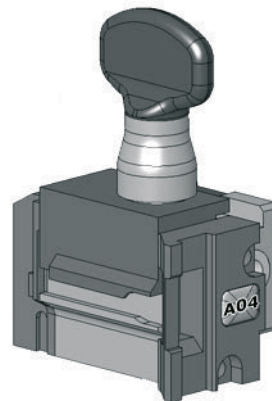

STANDARD



2.5 mm

RIC01810B
Fresino HC011
Cutter HC011
Fräser HC011
Fraise HC011
Fresa HC011



RIC01811B
Tastatore C011
Tracer Point C011
Taster C011
Palpeur C011
Palpador C011



303/304/305



**T-REX
T-REX ADVANCE**



PUNTO

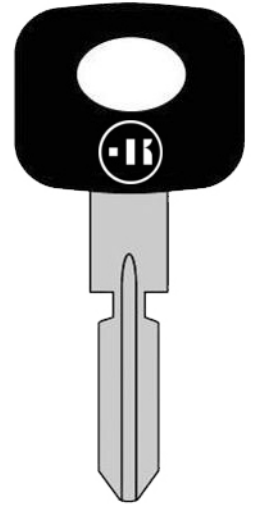

STANDARD

OPZ03182B
Morsetto A-994
Jaw A-994
Spannbacke A-994
Étau A-994
Mordaza A-994



994 LASER



MB52P



2.5 mm



RIC05304B
Fresino WC011A
Cutter WC011A
Fräser WC011A
Fraise WC011A
Fresa WC011A

STANDARD

OPZ09734B
Morsetto A/C - 997
Jaw A/C - 997
Spannbacke A/C - 997
Étau A/C - 997
Mordaza A/C - 997

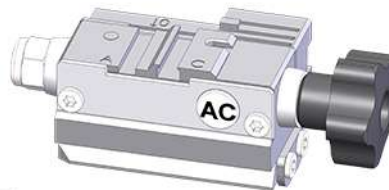

NINJA LASER



2.5 mm



RIC05304B
Fresino WC011A
Cutter WC011A
Fräser WC011A
Fraise WC011A
Fresa WC011A

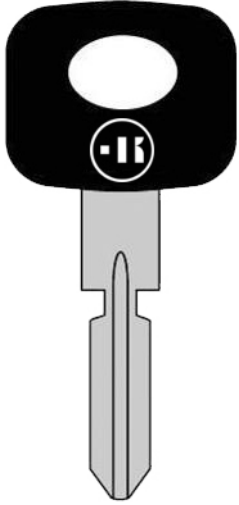

MB52P



NINJA VORTEX



VERSA



NINJA TOTAL

STANDARD
(VERSION 4 JAWS)



2.5 mm



RIC05048B
Fresino V003
Cutter V003
Fräser V003
Fraise V003
Fresa V003

OPZ04871B
Morsetto A01
Jaw A01
Spannbacke A01
Étau A01
Mordaza A01

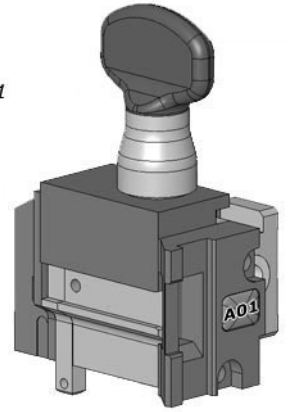

STANDARD



2.5 mm



RIC05048B
Fresino V003
Cutter V003
Fräser V003
Fraise V003
Fresa V003

OPZ10569B
Morsetto C30
Jaw C30
Spannbacke C30
Étau C30
Mordaza C30





OPZ03185B
Morsetto D-994
Jaw D-994
Spannbacke D-994
Étau D-994
Mordaza D-994
STANDARD



994 LASER

Short Keys



OPZ10269B
Adattatore AD05 per chiavi Short
Adaptor AD05 for Short keys
Adapter AD05 für Short-Schlüssel
Adaptateur AD05 pour clés Short
Adaptador AD05 para llaves Short
OPTIONAL

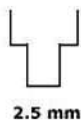

2.5 mm



RIC05304B
Fresino WC011A
Cutter WC011A
Fräser WC011A
Fraise WC011A
Fresa WC011A
STANDARD



OPZ09783B
Morsetto D - 997
Jaw D - 997
Spannbacke D - 997
Étau D - 997
Mordaza D - 997
STANDARD

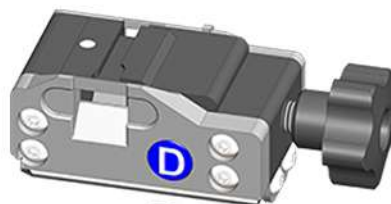

NINJA LASER

OPZ10269B
Adattatore AD05 per chiavi Short
Adaptor AD05 for Short keys
Adapter AD05 für Short-Schlüssel
Adaptateur AD05 pour clés Short
Adaptador AD05 para llaves Short
OPTIONAL

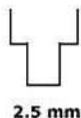

2.5 mm



RIC05304B
Fresino WC011A
Cutter WC011A
Fräser WC011A
Fraise WC011A
Fresa WC011A
STANDARD



2.5 mm

OPZ04877B
Morsetto A04
Jaw A04
Spannbacke A04
Étau A04
Mordaza A04
OPTIONAL

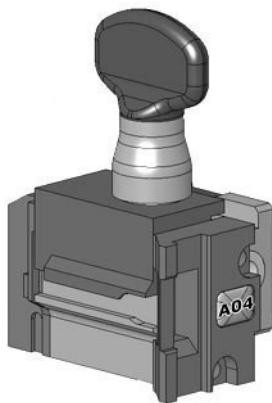

NINJA TOTAL



RIC05048B
Fresino V003
Cutter V003
Fräser V003
Fraise V003
Fresa V003
STANDARD
(VERSION 4 JAWS)



NINJA VORTEX

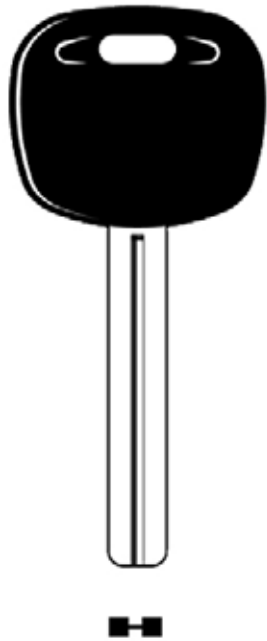

303/304/305

**T-REX
T-REX ADVANCE**

PUNTO

STANDARD

2.5 mm

RIC01810B
Fresino HC011
Cutter HC011
Fräser HC011
Fraise HC011
Fresa HC011

RIC01811B
Tastatore C011
Tracer Point C011
Taster C011
Palpeur C011
Palpador C011



994 LASER

STANDARD

OPZ03182B
Morsetto A-994
Jaw A-994
Spannbacke A-994
Étau A-994
Mordaza A-994

2.5 mm

RIC05304B
Fresino WC011A
Cutter WC011A
Fräser WC011A
Fraise WC011A
Fresa WC011A



NINJA LASER

STANDARD

OPZ09734B
Morsetto A/C - 997
Jaw A/C - 997
Spannbacke A/C - 997
Étau A/C - 997
Mordaza A/C - 997

2.5 mm

RIC05304B
Fresino WC011A
Cutter WC011A
Fräser WC011A
Fraise WC011A
Fresa WC011A

TO
FIT :

MITSUBISHI (J)

STANDARD
(VERSION 4 JAWS)



2.5 mm



RIC05048B
Fresino V003
Cutter V003
Fräser V003
Fraise V003
Fresa V003

OPZ04871B
Morsetto A01
Jaw A01
Spannbacke A01
Étau A01
Mordaza A01

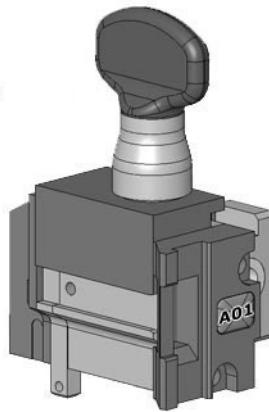

NINJA VORTEX



VERSA

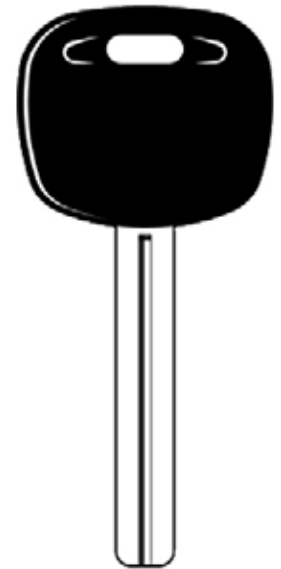

STANDARD



2.5 mm



RIC05048B
Fresino V003
Cutter V003
Fräser V003
Fraise V003
Fresa V003

OPZ10569B
Morsetto C30
Jaw C30
Spannbacke C30
Étau C30
Mordaza C30



NINJA TOTAL





NINJA TOTAL



NINJA VORTEX



VERSA

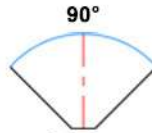

0.4 mm



RIC05044B
Fresino V001
Cutter V001
Fräser V001
Fraise V001
Fresa V001
STANDARD

OPZ07800B
Morsetto C15
Jaw C15
Spannbacke C15
Étau C15
Mordaza C15
OPTIONAL



TO
FIT :

OPEL (D) - VAUXHALL (GB)

OPTIONAL

MOMAX

Adattatori per chiavi Opel e Ford C-MAX
Adaptors for Opel and Ford C-MAX keys
Adapters für Opel und Ford C-MAX-Schlüssel
Adaptateurs pour clés Opel et Ford C-MAX
Adaptadores para llaves Opel y Ford C-MAX



STANDARD

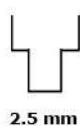

RIC01810B
Fresino HC011
Cutter HC011
Fräser HC011
Fraise HC011
Fresa HC011



RIC01811B
Tastatore C011
Tracer Point C011
Taster C011
Palpeur C011
Palpador C011



303/304/305



**T-REX
T-REX ADVANCE**



PUNTO



VX4TK12

VX4TK5

VX4P

VX3P

STANDARD

OPZ03182B

Morsetto A-994
Jaw A-994
Spannbacke A-994
Étau A-994
Mordaza A-994

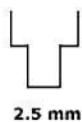

2.5 mm



RIC05304B
Fresino WC011A
Cutter WC011A
Fräser WC011A
Fraise WC011A
Fresa WC011A



994 LASER



STANDARD

OPZ09734B

Morsetto A/C - 997
Jaw A/C - 997
Spannbacke A/C - 997
Étau A/C - 997
Mordaza A/C - 997

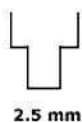
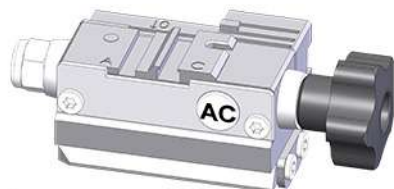

2.5 mm



RIC05304B
Fresino WC011A
Cutter WC011A
Fräser WC011A
Fraise WC011A
Fresa WC011A



NINJA LASER



VX3TK5



VX4TK12

VX4TK5

VX4P

VX3P



VX3TK5



NINJA VORTEX



VERSA



NINJA TOTAL

STANDARD
(VERSION 4 JAWS)



2.5 mm

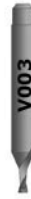

RIC05048B
Fresino V003
Cutter V003
Fräser V003
Fraise V003
Fresa V003

OPZ04871B
Morsetto A01
Jaw A01
Spannbacke A01
Étau A01
Mordaza A01

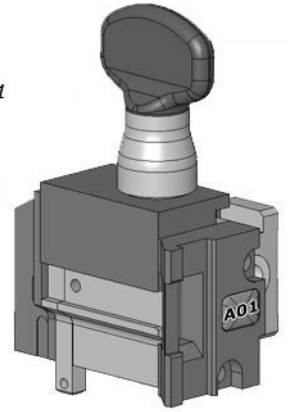

STANDARD



2.5 mm



RIC05048B
Fresino V003
Cutter V003
Fräser V003
Fraise V003
Fresa V003

OPZ10569B
Morsetto C30
Jaw C30
Spannbacke C30
Étau C30
Mordaza C30

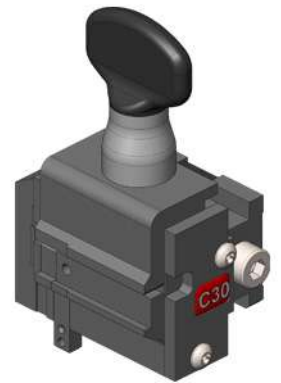

TO
FIT :

OPEL (D) - VAUXHALL (GB)

STANDARD



2.5 mm

RIC01810B
Fresino HC011
Cutter HC011
Fräser HC011
Fraise HC011
Fresa HC011



RIC01811B
Tastatore C011
Tracer Point C011
Taster C011
Palpeur C011
Palpador C011



303/304/305



**T-REX
T-REX ADVANCE**



PUNTO



VX5TK12

STANDARD

OPZ03182B
Morsetto A-994
Jaw A-994
Spannbacke A-994
Étau A-994
Mordaza A-994



2.5 mm



RIC05304B
Fresino WC011A
Cutter WC011A
Fräser WC011A
Fraise WC011A
Fresa WC011A



994 LASER

STANDARD

OPZ09734B
Morsetto A/C - 997
Jaw A/C - 997
Spannbacke A/C - 997
Étau A/C - 997
Mordaza A/C - 997

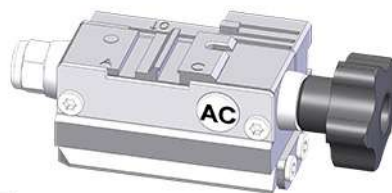

2.5 mm



RIC05304B
Fresino WC011A
Cutter WC011A
Fräser WC011A
Fraise WC011A
Fresa WC011A



NINJA LASER



VX5TK12



NINJA VORTEX



VERSA



NINJA TOTAL

STANDARD
(VERSION 4 JAWS)



2.5 mm



RIC05048B
Fresino V003
Cutter V003
Fräser V003
Fraise V003
Fresa V003

OPZ04871B
Morsetto A01
Jaw A01
Spannbacke A01
Étau A01
Mordaza A01

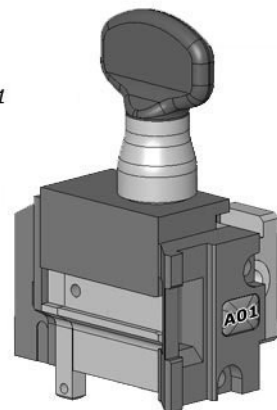

STANDARD



2.5 mm



RIC05048B
Fresino V003
Cutter V003
Fräser V003
Fraise V003
Fresa V003

OPZ10569B
Morsetto C30
Jaw C30
Spannbacke C30
Étau C30
Mordaza C30



OPTIONAL



2 mm

RIC01816B
Fresino HC044
Cutter HC044
Fräser HC044
Fraise HC044
Fresa HC044



RIC01817B
Tastatore C044
Tracer Point C044
Taster C044
Palpeur C044
Palpador C044



303/304/305



**T-REX
T-REX ADVANCE**



PUNTO



VX5BTK

STANDARD

OPZ05223B
Morsetto C-994
Jaw C-994
Spannbacke C-994
Étau C-994
Mordaza C-994



994 LASER



2.5 mm



RIC05304B
Fresino WC011A
Cutter WC011A
Fräser WC011A
Fraise WC011A
Fresa WC011A

STANDARD

OPZ09734B
Morsetto A/C - 997
Jaw A/C - 997
Spannbacke A/C - 997
Étau A/C - 997
Mordaza A/C - 997

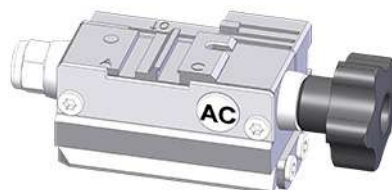

NINJA LASER



2.5 mm



RIC05304B
Fresino WC011A
Cutter WC011A
Fräser WC011A
Fraise WC011A
Fresa WC011A



NINJA TOTAL



NINJA VORTEX



VERSA

STANDARD
(VERSION 4 JAWS)



2.5 mm

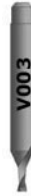

RIC05048B
Fresino V003
Cutter V003
Fräser V003
Fraise V003
Fresa V003

OPZ04875B
Morsetto A03
Jaw A03
Spannbacke A03
Étau A03
Mordaza A03

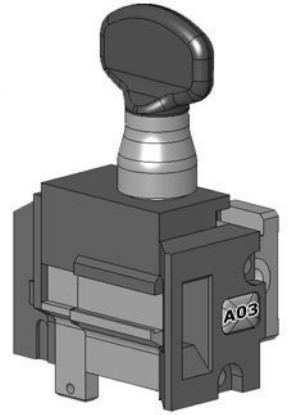

STANDARD



2.5 mm

RIC01810B
Fresino HC011
Cutter HC011
Fräser HC011
Fraise HC011
Fresa HC011



RIC01811B
Tastatore C011
Tracer Point C011
Taster C011
Palpeur C011
Palpador C011



303/304/305



**T-REX
T-REX ADVANCE**



PUNTO

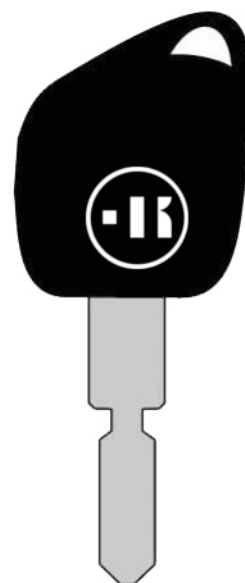

STANDARD

OPZ03183B
Morsetto B-994
Jaw B-994
Spannbacke B-994
Étau B-994
Mordaza B-994



994 LASER



2.5 mm



RIC05304B
Fresino WC011A
Cutter WC011A
Fräser WC011A
Fraise WC011A
Fresa WC011A



PG31TK1

STANDARD

OPZ09781B
Morsetto B - 997
Jaw B - 997
Spannbacke B - 997
Étau B - 997
Mordaza B - 997



NINJA LASER



2.5 mm



RIC05304B
Fresino WC011A
Cutter WC011A
Fräser WC011A
Fraise WC011A
Fresa WC011A

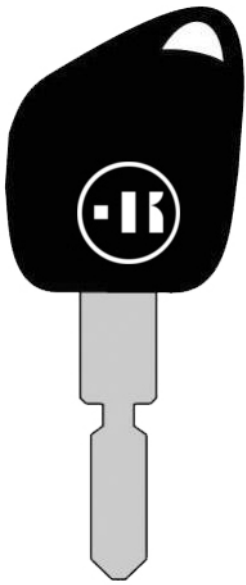

PG31TK1



NINJA TOTAL



NINJA VORTEX



VERSA

STANDARD
(VERSION 4 JAWS)



2.5 mm



RIC05048B
Fresino V003
Cutter V003
Fräser V003
Fraise V003
Fresa V003

OPZ04873B
Morsetto A02
Jaw A02
Spannbacke A02
Étau A02
Mordaza A02

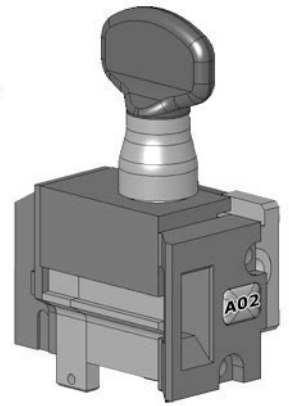

OPTIONAL



3,0 mm

RIC01715B
Fresino HC030
Cutter HC030
Fräser HC030
Fraise HC030
Fresa HC030



RIC01716B
Tastatore C030
Tracer Point C030
Taster C030
Palpeur C030
Palpador C030



303/304/305



**T-REX
T-REX ADVANCE**



PUNTO



PG83TK

STANDARD

OPZ05223B
Morsetto C-994
Jaw C-994
Spannbacke C-994
Étau C-994
Mordaza C-994



994 LASER



2.5 mm



RIC05304B
Fresino WC011A
Cutter WC011A
Fräser WC011A
Fraise WC011A
Fresa WC011A

STANDARD

OPZ09734B
Morsetto A/C - 997
Jaw A/C - 997
Spannbacke A/C - 997
Étau A/C - 997
Mordaza A/C - 997

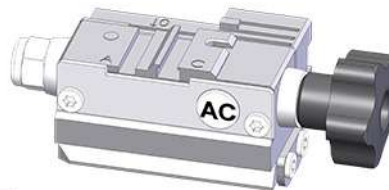

NINJA LASER



2.5 mm



RIC05304B
Fresino WC011A
Cutter WC011A
Fräser WC011A
Fraise WC011A
Fresa WC011A



PG83TK



NINJA TOTAL



NINJA VORTEX



VERSA

STANDARD
(VERSION 4 JAWS)



2.5 mm

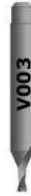

RIC05048B
Fresino V003
Cutter V003
Fräser V003
Fraise V003
Fresa V003

OPZ04875B
Morsetto A03
Jaw A03
Spannbacke A03
Étau A03
Mordaza A03

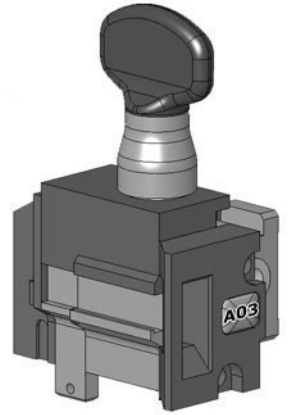

STANDARD



2.5 mm

RIC01810B
Fresino HC011
Cutter HC011
Fräser HC011
Fraise HC011
Fresa HC011



RIC01811B
Tastatore C011
Tracer Point C011
Taster C011
Palpeur C011
Palpador C011



303/304/305



**T-REX
T-REX ADVANCE**



PUNTO



STANDARD

OPZ03182B
Morsetto A-994
Jaw A-994
Spannbacke A-994
Étau A-994
Mordaza A-994



994 LASER

PG33TK



2.5 mm



RIC05304B
Fresino WC011A
Cutter WC011A
Fräser WC011A
Fraise WC011A
Fresa WC011A

STANDARD

OPZ09734B
Morsetto A/C - 997
Jaw A/C - 997
Spannbacke A/C - 997
Étau A/C - 997
Mordaza A/C - 997

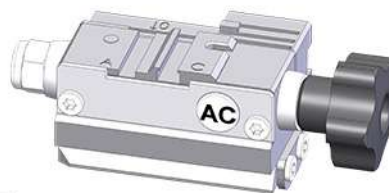

NINJA LASER



2.5 mm



RIC05304B
Fresino WC011A
Cutter WC011A
Fräser WC011A
Fraise WC011A
Fresa WC011A



PG33TK



NINJA TOTAL



NINJA VORTEX



VERSA

STANDARD
(VERSION 4 JAWS)



2.5 mm

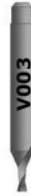

RIC05048B
Fresino V003
Cutter V003
Fräser V003
Fraise V003
Fresa V003

OPZ04875B
Morsetto A03
Jaw A03
Spannbacke A03
Étau A03
Mordaza A03

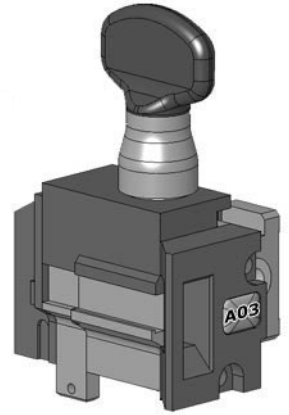

OPTIONAL

MC

*Adattatori per chiavi Simplex
Adaptors for Simplex keys
Adapters für Simplex-Schlüssel
Adaptateurs pour clés Simplex
Adaptadores para llaves Simplex*



CARAT/106



**101/102
103/104**



**EURO/ECO
EASY/LUPO**



OPTIONAL

OPZ09733B

*Morsetto S per chiavi Simplex
Jaw S for Simplex keys
Spannbacke S für Simplex-Schlüssel
Étau S pour clés Simplex
Mordaza S para llaves Simplex*

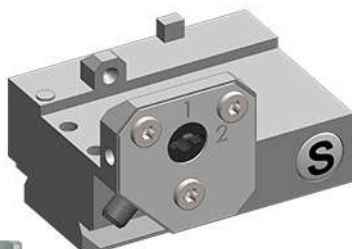

RIC08409B
*Fresino CL004
Cutter CL004
Fräser CL004
Fraise CL004
Fresa CL004*

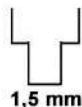

1,5 mm



INCLUDED WITH JAW
*Tastatore TL002
Tracer Point TL002
Taster TL002
Palpeur TL002
Palpador TL002*



994 LASER



**CN22AP
CN22CP
CN22U
CN22TK1
CN22TK8**



DEZMO



NINJA LASER



NINJA TOTAL

OPTIONAL



OPZ08264B

*Adattatore B6 per chiavi Simplex
Adaptor B6 sides for Simplex keys
Adapter B6 für Simplex Schlüssel
Adaptateur B6 pour clés Simplex
Adaptador B6 para llaves Simplex*



**CN22AP
CN22CP
CN22U
CN22TK1
CN22TK8**



OPZ05223B
Morsetto C-994
Jaw C-994
Spannbacke C-994
Étau C-994
Mordaza C-994
STANDARD



994 LASER

OPZ10063B
Adattatore AD04 per chiavi Renault
Adaptor AD04 for Renault keys
Adapter AD04 für Renault-Schlüssel
Adaptateur AD04 pour clés Renault
Adaptador AD04 para llaves Renault
OPTIONAL

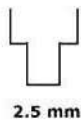

2.5 mm



RIC05304B
Fresino WC011A
Cutter WC011A
Fräser WC011A
Fraise WC011A
Fresa WC011A
STANDARD

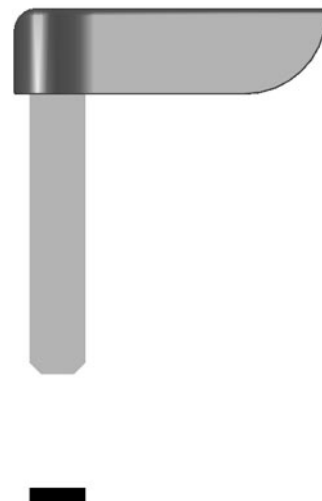

OPZ09734B
Morsetto A/C - 997
Jaw A/C - 997
Spannbacke A/C - 997
Étau A/C - 997
Mordaza A/C - 997
STANDARD

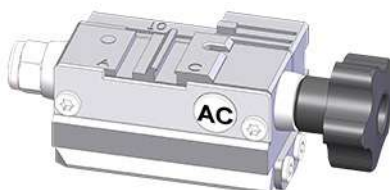

NINJA LASER

OPZ10063B
Adattatore AD04 per chiavi Renault
Adaptor AD04 for Renault keys
Adapter AD04 für Renault-Schlüssel
Adaptateur AD04 pour clés Renault
Adaptador AD04 para llaves Renault
OPTIONAL

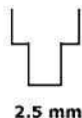

2.5 mm



RIC05304B
Fresino WC011A
Cutter WC011A
Fräser WC011A
Fraise WC011A
Fresa WC011A
STANDARD

OPZ05345B
Adattatore AV02 per chiavi Renault
Adaptor AV02 for Renault keys
Adapter AV02 für Renault-Schlüssel
Adaptateur AV02 pour clés Renault
Adaptador AV02 para llaves Renault
OPTIONAL

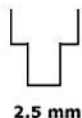

2.5 mm



OPZ04875B
Morsetto A03
Jaw A03
Spannbacke A03
Étau A03
Mordaza A03
STANDARD
(VERSION 4 JAWS)

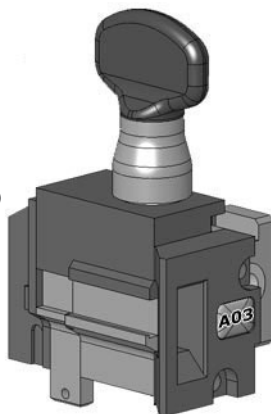

NINJA TOTAL



NINJA VORTEX

RIC05048B
Fresino V003
Cutter V003
Fräser V003
Fraise V003
Fresa V003
STANDARD
(VERSION 4 JAWS)



VERSA

TO FIT: **RENAULT (F)**

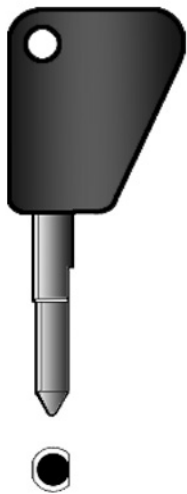

CARAT/106



**101/102
103/104**



**EURO/ECO
EASY/LUPO**

OPTIONAL

MR30

*Adattatori per chiavi Renault
Adaptors for Renault keys
Adapters für Renault-Schlüssel
Adaptateurs pour clés Renault
Adaptadores para llaves Renault*



TO FIT: **SAAB (S)**



303/304/305



**T-REX
T-REX ADVANCE**



PUNTO

STANDARD



2.5 mm

RIC01810B

*Fresino HC011
Cutter HC011
Fräser HC011
Fraise HC011
Fresa HC011*



RIC01811B

*Tastatore C011
Tracer Point C011
Taster C011
Palpeur C011
Palpador C011*

STANDARD

OPZ03182B

Morsetto A-994
Jaw A-994
Spannbacke A-994
Étau A-994
Mordaza A-994



994 LASER

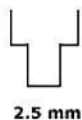

2.5 mm



RIC05304B

Fresino WC011A
Cutter WC011A
Fräser WC011A
Fraise WC011A
Fresa WC011A

STANDARD

OPZ09734B

Morsetto A/C - 997
Jaw A/C - 997
Spannbacke A/C - 997
Étau A/C - 997
Mordaza A/C - 997

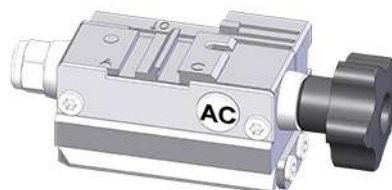

NINJA LASER

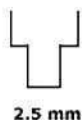

2.5 mm



RIC05304B

Fresino WC011A
Cutter WC011A
Fräser WC011A
Fraise WC011A
Fresa WC011A

STANDARD
(VERSION 4 JAWS)



2.5 mm

OPZ04871B

Morsetto A01
Jaw A01
Spannbacke A01
Étau A01
Mordaza A01

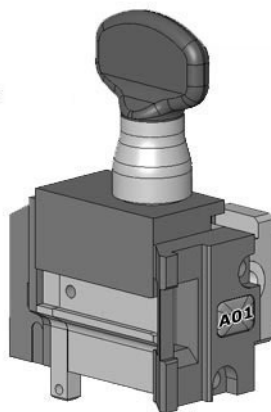

NINJA VORTEX

RIC05048B

Fresino V003
Cutter V003
Fräser V003
Fraise V003
Fresa V003



VERSA

STANDARD



2.5 mm

OPZ10569B

Morsetto C30
Jaw C30
Spannbacke C30
Étau C30
Mordaza C30



NINJA TOTAL

RIC05048B

Fresino V003
Cutter V003
Fräser V003
Fraise V003
Fresa V003





V66TK1

V66TK8

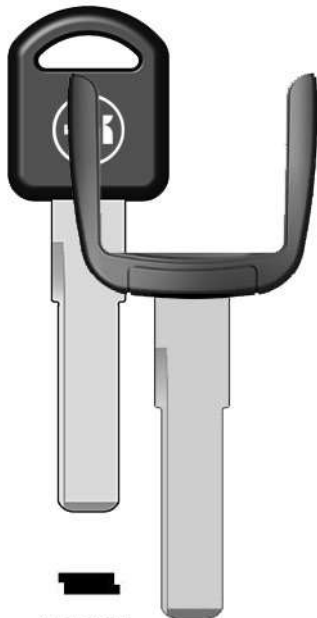

V66BP

V66TKU



OPTIONAL

MA

Adattatori per chiavi VAG
Adaptors for VAG keys
Adapters für VAG-Schlüssel
Adaptateurs pour clés VAG
Adaptadores para llaves VAG



STANDARD

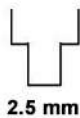

RIC01810B
Fresino HC011
Cutter HC011
Fräser HC011
Fraise HC011
Fresa HC011



RIC01811B
Tastatore C011
Tracer Point C011
Taster C011
Palpeur C011
Palpador C011

OPTIONAL



RIC01715B
Fresino HC030
Cutter HC030
Fräser HC030
Fraise HC030
Fresa HC030



RIC01716B
Tastatore C030
Tracer Point C030
Taster C030
Palpeur C030
Palpador C030

STANDARD



RIC01810B
Fresino HC011
Cutter HC011
Fräser HC011
Fraise HC011
Fresa HC011

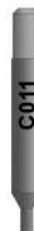

RIC01811B
Tastatore C011
Tracer Point C011
Taster C011
Palpeur C011
Palpador C011

OPTIONAL



RIC01715B
Fresino HC030
Cutter HC030
Fräser HC030
Fraise HC030
Fresa HC030



RIC01716B
Tastatore C030
Tracer Point C030
Taster C030
Palpeur C030
Palpador C030

STANDARD

OPZ05223B

Morsetto C-994
Jaw C-994
Spannbacke C-994
Étau C-994
Mordaza C-994



994 LASER

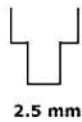

2.5 mm



RIC05304B

Fresino WC011A
Cutter WC011A
Fräser WC011A
Fraise WC011A
Fresa WC011A



STANDARD

OPZ09734B

Morsetto A/C - 997
Jaw A/C - 997
Spannbacke A/C - 997
Étau A/C - 997
Mordaza A/C - 997

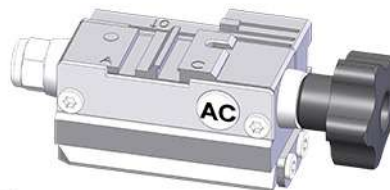

NINJA LASER

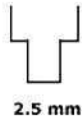

2.5 mm



RIC05304B

Fresino WC011A
Cutter WC011A
Fräser WC011A
Fraise WC011A
Fresa WC011A



V66TK1



V66TK8

STANDARD
(VERSION 4 JAWS)



2.5 mm

OPZ04875B

Morsetto A03
Jaw A03
Spannbacke A03
Étau A03
Mordaza A03

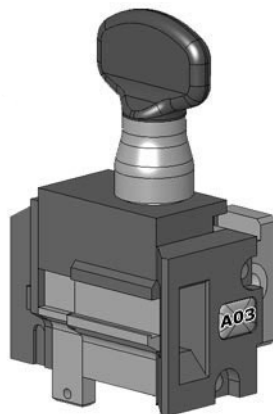

NINJA TOTAL



NINJA VORTEX



VERSA



RIC05048B

Fresino V003
Cutter V003
Fräser V003
Fraise V003
Fresa V003

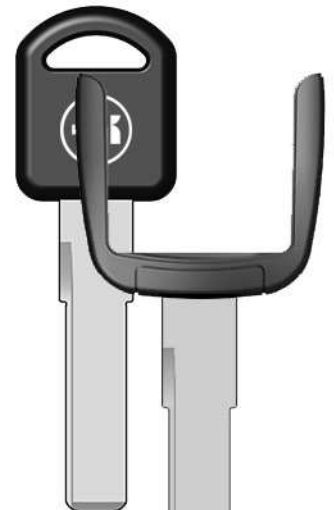

V66BP



V66TKU

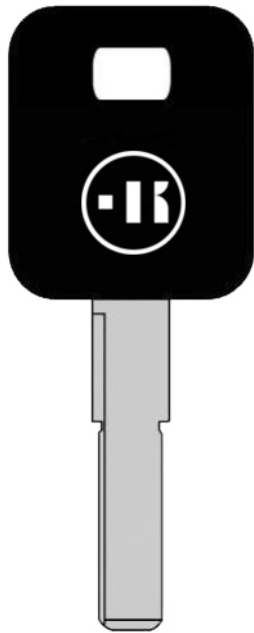

AD66TK1

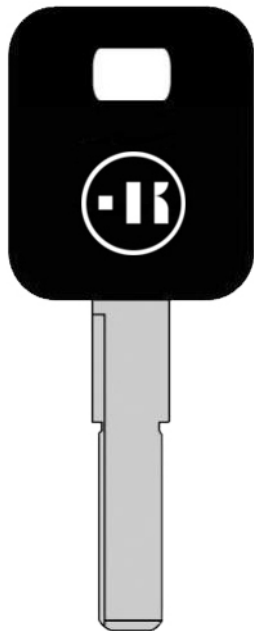

AD66TK8



303/304/305



PUNTO



T-REX
T-REX ADVANCE

OPTIONAL

MA

Adattatori per chiavi VAG
Adaptors for VAG keys
Adapters für VAG-Schlüssel
Adaptateurs pour clés VAG
Adaptadores para llaves VAG



STANDARD



2.5 mm

RIC01810B
Fresino HC011
Cutter HC011
Fräser HC011
Fraise HC011
Fresa HC011



RIC01811B
Tastatore C011
Tracer Point C011
Taster C011
Palpeur C011
Palpador C011

OPTIONAL



3.0 mm

RIC01715B
Fresino HC030
Cutter HC030
Fräser HC030
Fraise HC030
Fresa HC030



RIC01716B
Tastatore C030
Tracer Point C030
Taster C030
Palpeur C030
Palpador C030

STANDARD



2,5 mm

RIC01810B
Fresino HC011
Cutter HC011
Fräser HC011
Fraise HC011
Fresa HC011



RIC01811B
Tastatore C011
Tracer Point C011
Taster C011
Palpeur C011
Palpador C011

OPTIONAL



3,0 mm

RIC01715B
Fresino HC030
Cutter HC030
Fräser HC030
Fraise HC030
Fresa HC030



RIC01716B
Tastatore C030
Tracer Point C030
Taster C030
Palpeur C030
Palpador C030

STANDARD

OPZ05223B

Morsetto C-994
Jaw C-994
Spannbacke C-994
Étau C-994
Mordaza C-994



994 LASER



2.5 mm



RIC05304B

Fresino WC011A
Cutter WC011A
Fräser WC011A
Fraise WC011A
Fresa WC011A

STANDARD

OPZ09734B

Morsetto A/C - 997
Jaw A/C - 997
Spannbacke A/C - 997
Étau A/C - 997
Mordaza A/C - 997

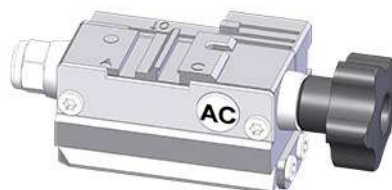

NINJA LASER



2.5 mm



RIC05304B

Fresino WC011A
Cutter WC011A
Fräser WC011A
Fraise WC011A
Fresa WC011A

STANDARD
(VERSION 4 JAWS)



2.5 mm



RIC05048B

Fresino V003
Cutter V003
Fräser V003
Fraise V003
Fresa V003

OPZ04875B

Morsetto A03
Jaw A03
Spannbacke A03
Étau A03
Mordaza A03

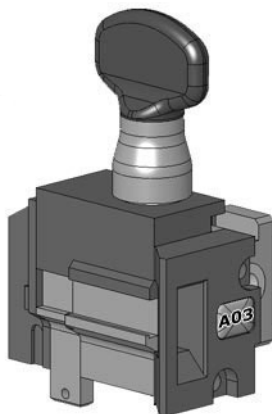

NINJA TOTAL



NINJA VORTEX



VERSA

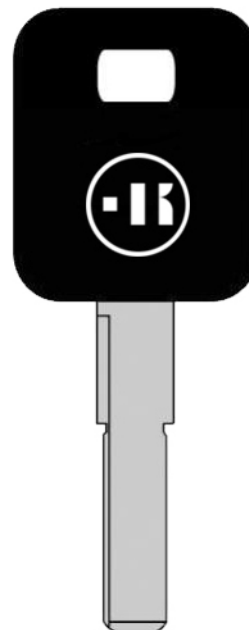

AD66TK1

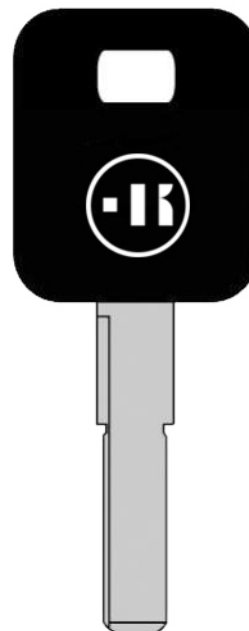

AD66TK8

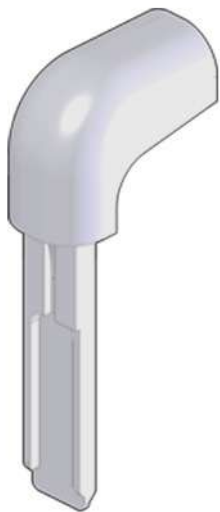

EMERGENCY KEY



994 LASER

OPZ03182B
 Morsetto A-994
 Jaw A-994
 Spannbacke A-994
 Étau A-994
 Mordaza A-994
STANDARD



OPZ05223B
 Morsetto C-994
 Jaw C-994
 Spannbacke C-994
 Étau C-994
 Mordaza C-994
STANDARD



OPZ07885B
 Adattatore AD03 per chiavi Lexus
 Adaptor AD03 for Lexus keys
 Adapter AD03 für Lexus-Schlüssel
 Adaptateur AD03 pour clés Lexus
 Adaptador AD03 para llaves Lexus
OPTIONAL



RIC05304B
 Fresino WC011A
 Cutter WC011A
 Fräser WC011A
 Fraise WC011A
 Fresa WC011A
STANDARD



NINJA LASER

OPZ09734B
 Morsetto A/C - 997
 Jaw A/C - 997
 Spannbacke A/C - 997
 Étau A/C - 997
 Mordaza A/C - 997
STANDARD

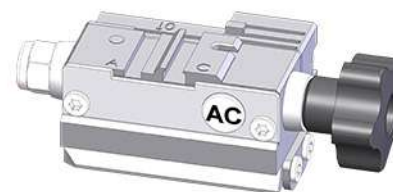

OPZ07885B
 Adattatore AD03 per chiavi Lexus
 Adaptor AD03 for Lexus keys
 Adapter AD03 für Lexus-Schlüssel
 Adaptateur AD03 pour clés Lexus
 Adaptador AD03 para llaves Lexus
OPTIONAL

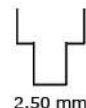

RIC05304B
 Fresino WC011A
 Cutter WC011A
 Fräser WC011A
 Fraise WC011A
 Fresa WC011A
STANDARD



NINJA VORTEX

OPZ04871B
 Morsetto A01
 Jaw A01
 Spannbacke A01
 Étau A01
 Mordaza A01
STANDARD
 (VERSION 4 JAWS)



OPZ10631B
 Adattatore AD06
 Adaptor AD06
 Adapter AD06
 Adaptateur AD06
 Adaptador AD06
OPTIONAL



RIC05048B
 Fresino V003
 Cutter V003
 Fräser V003
 Fraise V003
 Fresa V003
STANDARD
 (VERSION 4 JAWS)

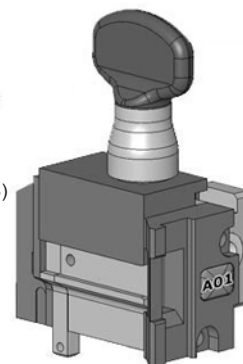

VERSA

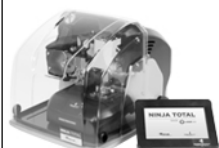

NINJA TOTAL

OPZ10569B
 Morsetto C30
 Jaw C30
 Spannbacke C30
 Étau C30
 Mordaza C30
STANDARD



OPZ10631B
 Adattatore AD06
 Adaptor AD06
 Adapter AD06
 Adaptateur AD06
 Adaptador AD06
OPTIONAL



RIC05048B
 Fresino V003
 Cutter V003
 Fräser V003
 Fraise V003
 Fresa V003
STANDARD

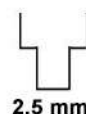

STANDARD



2.5 mm

RIC01810B
Fresino HC011
Cutter HC011
Fräser HC011
Fraise HC011
Fresa HC011



RIC01811B
Tastatore C011
Tracer Point C011
Taster C011
Palpeur C011
Palpador C011



303/304/305



**T-REX
T-REX ADVANCE**



PUNTO



STANDARD

OPZ03182B
Morsetto A-994
Jaw A-994
Spannbacke A-994
Étau A-994
Mordaza A-994



2.5 mm



RIC05304B
Fresino WC011A
Cutter WC011A
Fräser WC011A
Fraise WC011A
Fresa WC011A



994 LASER



TR48TK TR49P

STANDARD

OPZ09734B
Morsetto A/C - 997
Jaw A/C - 997
Spannbacke A/C - 997
Étau A/C - 997
Mordaza A/C - 997

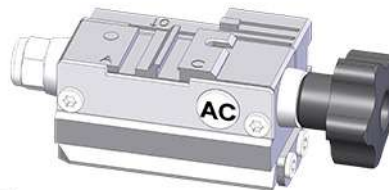

2.5 mm



RIC05304B
Fresino WC011A
Cutter WC011A
Fräser WC011A
Fraise WC011A
Fresa WC011A



NINJA LASER



TR49BTK3



TR48TK TR49P



TR49BTK3



NINJA VORTEX



VERSA



NINJA TOTAL

STANDARD
(VERSION 4 JAWS)



2.5 mm



RIC05048B
Fresino V003
Cutter V003
Fräser V003
Fraise V003
Fresa V003

OPZ04871B
Morsetto A01
Jaw A01
Spannbacke A01
Étau A01
Mordaza A01

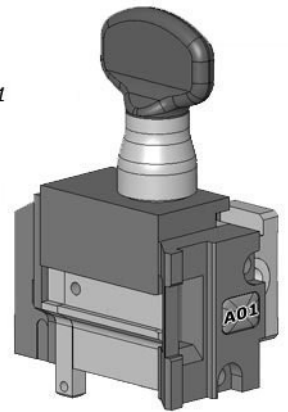

STANDARD



2.5 mm



RIC05048B
Fresino V003
Cutter V003
Fräser V003
Fraise V003
Fresa V003

OPZ10569B
Morsetto C30
Jaw C30
Spannbacke C30
Étau C30
Mordaza C30



OPZ03182B
Morsetto A-994
Jaw A-994
Spannbacke A-994
Étau A-994
Mordaza A-994
STANDARD



OPZ05223B
Morsetto C-994
Jaw C-994
Spannbacke C-994
Étau C-994
Mordaza C-994
STANDARD



RIC05304B
Fresino WC011A
Cutter WC011A
Fräser WC011A
Fraise WC011A
Fresa WC011A
STANDARD



994 LASER



OPZ07885B

Adattatore AD03 per chiavi Lexus
Adaptor AD03 for Lexus keys
Adapter AD03 für Lexus-Schlüssel
Adaptateur AD03 pour clés Lexus
Adaptador AD03 para llaves Lexus
OPTIONAL



EMERGENCY KEY

OPZ09734B
Morsetto A/C - 997
Jaw A/C - 997
Spannbacke A/C - 997
Étau A/C - 997
Mordaza A/C - 997
STANDARD

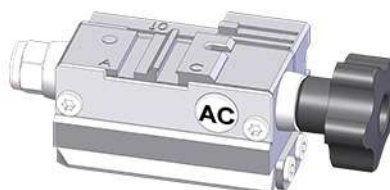

NINJA LASER



OPZ07885B

Adattatore AD03 per chiavi Lexus
Adaptor AD03 for Lexus keys
Adapter AD03 für Lexus-Schlüssel
Adaptateur AD03 pour clés Lexus
Adaptador AD03 para llaves Lexus
OPTIONAL

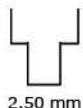

RIC05304B
Fresino WC011A
Cutter WC011A
Fräser WC011A
Fraise WC011A
Fresa WC011A
STANDARD



OPZ10631B

Adattatore AD06
Adaptor AD06
Adapter AD06
Adaptateur AD06
Adaptador AD06
OPTIONAL



RIC05048B
Fresino V003
Cutter V003
Fräser V003
Fraise V003
Fresa V003
STANDARD
(VERSION 4 JAWS)

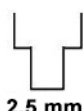

OPZ04871B
Morsetto A01
Jaw A01
Spannbacke A01
Étau A01
Mordaza A01
STANDARD
(VERSION 4 JAWS)

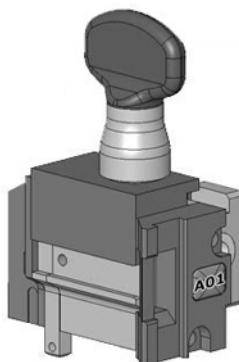

NINJA VORTEX



VERSA



OPZ10631B

Adattatore AD06
Adaptor AD06
Adapter AD06
Adaptateur AD06
Adaptador AD06
OPTIONAL



RIC05048B
Fresino V003
Cutter V003
Fräser V003
Fraise V003
Fresa V003
STANDARD
(VERSION 4 JAWS)

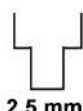

OPZ10569B
Morsetto C30
Jaw C30
Spannbacke C30
Étau C30
Mordaza C30
STANDARD



NINJA TOTAL



V66TK1

V66TK8

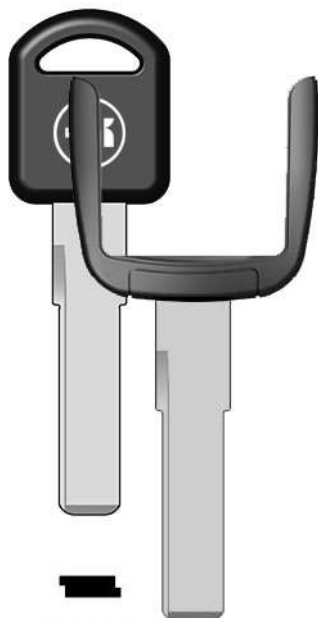

V66BP

V66TKU



303/304/305



PUNTO



T-REX
T-REX ADVANCE

OPTIONAL

MA

Adattatori per chiavi VAG
Adaptors for VAG keys
Adapters für VAG-Schlüssel
Adaptateurs pour clés VAG
Adaptadores para llaves VAG



STANDARD

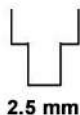

2.5 mm

RIC01810B
Fresino HC011
Cutter HC011
Fräser HC011
Fraise HC011
Fresa HC011



RIC01811B
Tastatore C011
Tracer Point C011
Taster C011
Palpeur C011
Palpador C011

OPTIONAL



3.0 mm

RIC01715B
Fresino HC030
Cutter HC030
Fräser HC030
Fraise HC030
Fresa HC030



RIC01716B
Tastatore C030
Tracer Point C030
Taster C030
Palpeur C030
Palpador C030

STANDARD



2,5 mm

RIC01810B
Fresino HC011
Cutter HC011
Fräser HC011
Fraise HC011
Fresa HC011

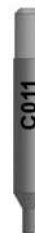

RIC01811B
Tastatore C011
Tracer Point C011
Taster C011
Palpeur C011
Palpador C011

OPTIONAL

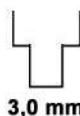

3,0 mm

RIC01715B
Fresino HC030
Cutter HC030
Fräser HC030
Fraise HC030
Fresa HC030



RIC01716B
Tastatore C030
Tracer Point C030
Taster C030
Palpeur C030
Palpador C030

TO
FIT :

VOLKSWAGEN (D)

STANDARD

OPZ05223B

Morsetto C-994
Jaw C-994
Spannbacke C-994
Étau C-994
Mordaza C-994



2.5 mm



RIC05304B

Fresino WC011A
Cutter WC011A
Fräser WC011A
Fraise WC011A
Fresa WC011A



994 LASER



STANDARD

OPZ09734B

Morsetto A/C - 997
Jaw A/C - 997
Spannbacke A/C - 997
Étau A/C - 997
Mordaza A/C - 997

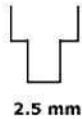
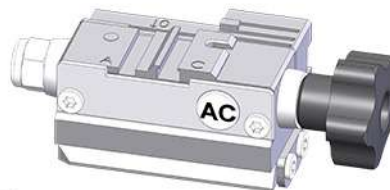

2.5 mm



RIC05304B

Fresino WC011A
Cutter WC011A
Fräser WC011A
Fraise WC011A
Fresa WC011A



NINJA LASER



V66TK1



V66TK8

STANDARD (VERSION 4 JAWS)



2.5 mm



RIC05048B

Fresino V003
Cutter V003
Fräser V003
Fraise V003
Fresa V003

OPZ04875B

Morsetto A03
Jaw A03
Spannbacke A03
Étau A03
Mordaza A03

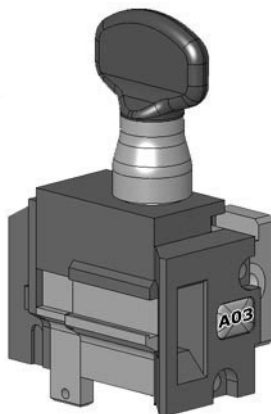

NINJA TOTAL



NINJA VORTEX



VERSA

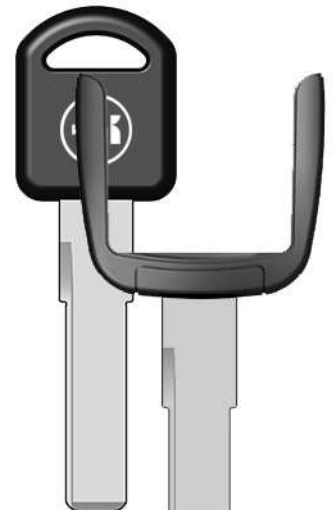

V66BP



V66TKU



HU162U



303/304/305
T-REX
T-REX ADVANCE
PUNTO

OPTIONAL



1.5 mm

RIC01812B
Fresino HC023
Cutter HC023
Fräser HC023
Fraise HC023
Fresa HC023



RIC01813B
Tastatore C023
Tracer Point C023
Taster C023
Palpeur C023
Palpador C023



NINJA LASER
994 LASER
NINJA TOTAL

OPTIONAL

OPZ10260B
Morsetto V per chiavi Volkswagen
Jaw V for Volkswagen keys
Spannbacke V für Volkswagen-Schlüssel
Étau V pour clés Volkswagen
Mordaza V para llaves Volkswagen

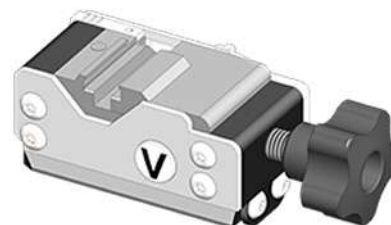

RIC09617B
Fresino CL005
Cutter CL005
Fräser CL005
Fraise CL005
Fresa CL005



1,5 mm



NINJA VORTEX
VERSA

OPTIONAL



1.5 mm

RIC05274B
Fresino V012
Cutter V012
Fräser V012
Fraise V012
Fresa V012



OPZ10618B
Morsetto A13
Jaw A13
Spannbacke A13
Étau A13
Mordaza A13

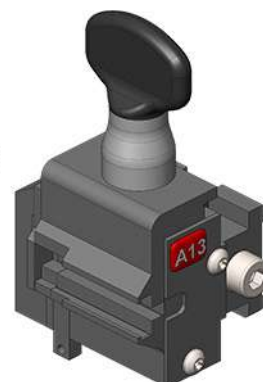

OPTIONAL



1.5 mm

RIC01812B
Fresino HC023
Cutter HC023
Fräser HC023
Fraise HC023
Fresa HC023



RIC01813B
Tastatore C023
Tracer Point C023
Taster C023
Palpeur C023
Palpador C023



303/304/305



**T-REX
T-REX ADVANCE**



PUNTO



994 LASER



HU163SU

OPZ05223B

Morsetto C-994
Jaw C-994
Spannbacke C-994
Étau C-994
Mordaza C-994

STANDARD



RIC09617B
Fresino CL005
Cutter CL005
Fräser CL005
Fraise CL005
Fresa CL005
OPTIONAL



1,5 mm

OPZ09734B

Morsetto A/C - 997
Jaw A/C - 997
Spannbacke A/C - 997
Étau A/C - 997
Mordaza A/C - 997

STANDARD

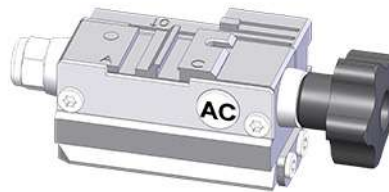

RIC09617B
Fresino CL005
Cutter CL005
Fräser CL005
Fraise CL005
Fresa CL005
OPTIONAL



1,5 mm



NINJA LASER



HU163SU



NINJA TOTAL



NINJA VORTEX



VERSA



1.5 mm



RIC05274B
Fresino V012
Cutter V012
Fräser V012
Fraise V012
Fresa V012
OPTIONAL

OPZ04875B
Morsetto A03
Jaw A03
Spannbacke A03
Étau A03
Mordaza A03
STANDARD
(VERSION 4 JAWS)

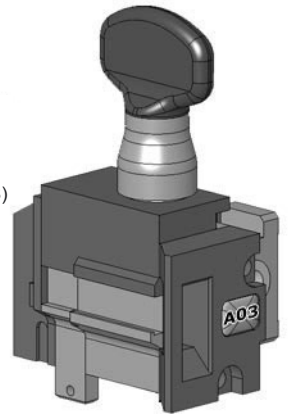

STANDARD



2.5 mm

RIC01810B
Fresino HC011
Cutter HC011
Fräser HC011
Fraise HC011
Fresa HC011



RIC01811B
Tastatore C011
Tracer Point C011
Taster C011
Palpeur C011
Palpador C011



303/304/305



**T-REX
T-REX ADVANCE**



PUNTO

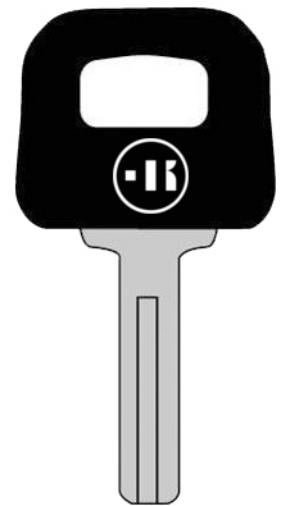

VL17P

STANDARD

OPZ03182B
Morsetto A-994
Jaw A-994
Spannbacke A-994
Étau A-994
Mordaza A-994



2.5 mm



RIC05304B
Fresino WC011A
Cutter WC011A
Fräser WC011A
Fraise WC011A
Fresa WC011A



994 LASER

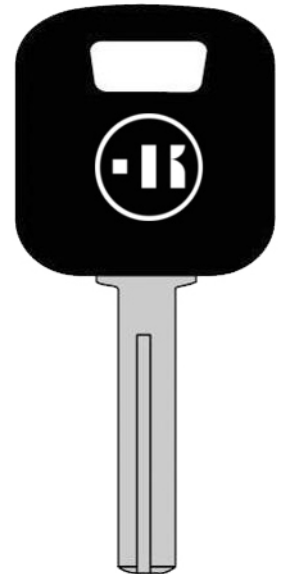

VL17TK1

STANDARD

OPZ09734B
Morsetto A/C - 997
Jaw A/C - 997
Spannbacke A/C - 997
Étau A/C - 997
Mordaza A/C - 997

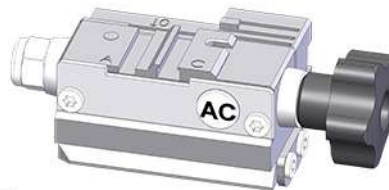

2.5 mm



RIC05304B
Fresino WC011A
Cutter WC011A
Fräser WC011A
Fraise WC011A
Fresa WC011A



NINJA LASER

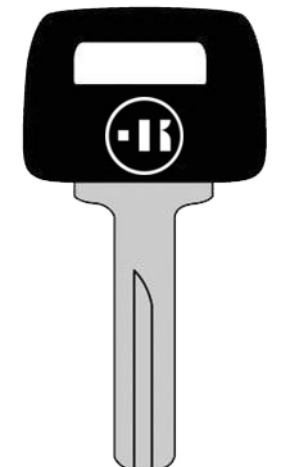

VL18P

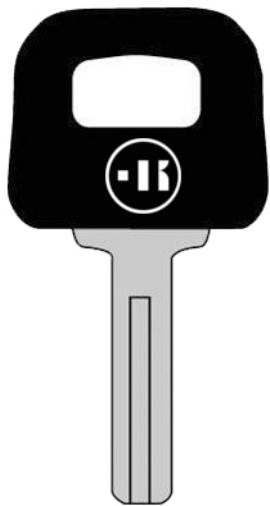

H
VL17P

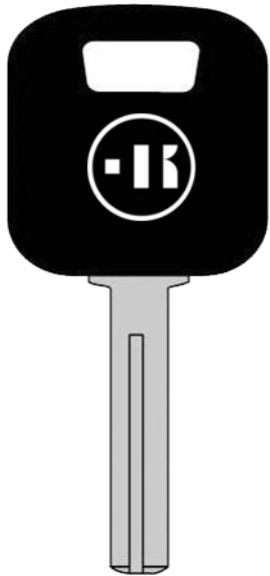

H
VL17TK1

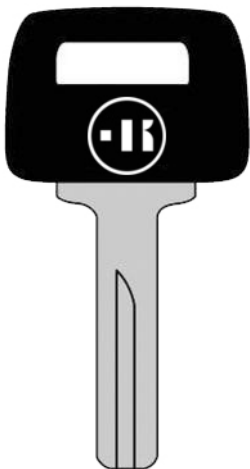

N
VL18P



NINJA VORTEX



VERSA



NINJA TOTAL

STANDARD
(VERSION 4 JAWS)



2.5 mm



RIC05048B
Fresino V003
Cutter V003
Fräser V003
Fraise V003
Fresa V003

OPZ04871B
Morsetto A01
Jaw A01
Spannbacke A01
Étau A01
Mordaza A01

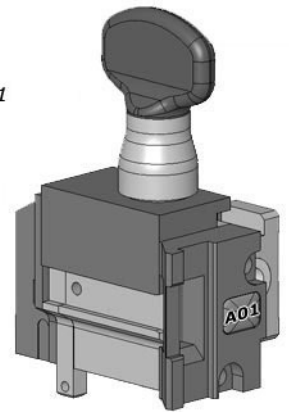

STANDARD



2.5 mm



RIC05048B
Fresino V003
Cutter V003
Fräser V003
Fraise V003
Fresa V003

OPZ10569B
Morsetto C30
Jaw C30
Spannbacke C30
Étau C30
Mordaza C30

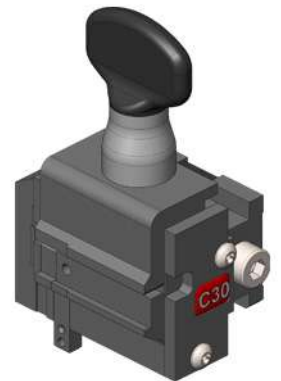

STANDARD



2.5 mm

RIC01810B
Fresino HC011
Cutter HC011
Fräser HC011
Fraise HC011
Fresa HC011



RIC01811B
Tastatore C011
Tracer Point C011
Taster C011
Palpeur C011
Palpador C011



303/304/305



**T-REX
T-REX ADVANCE**



PUNTO

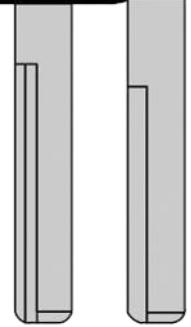
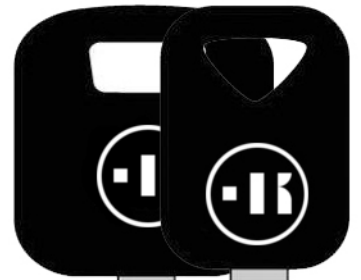

VL15TK1 VL16P

STANDARD

OPZ03183B
Morsetto B-994
Jaw B-994
Spannbacke B-994
Étau B-994
Mordaza B-994



2.5 mm



RIC05304B
Fresino WC011A
Cutter WC011A
Fräser WC011A
Fraise WC011A
Fresa WC011A



994 LASER

STANDARD

OPZ09781B
Morsetto B - 997
Jaw B - 997
Spannbacke B - 997
Étau B - 997
Mordaza B - 997



2.5 mm



RIC05304B
Fresino WC011A
Cutter WC011A
Fräser WC011A
Fraise WC011A
Fresa WC011A



NINJA LASER

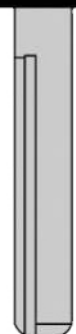

VL15P

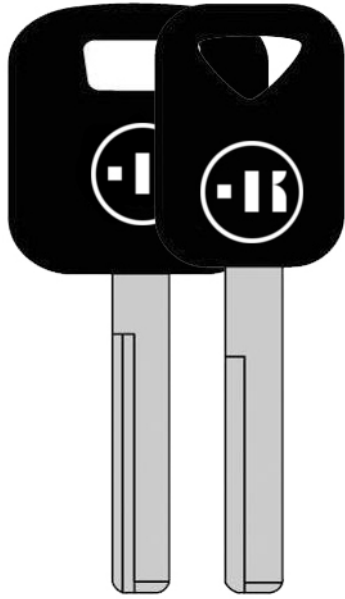

VL15TK1 VL16P

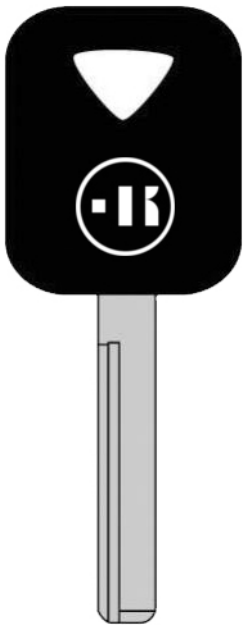

VL15P



NINJA TOTAL



NINJA VORTEX



VERSA

STANDARD
(VERSION 4 JAWS)



2.5 mm

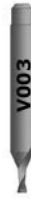

RIC05048B
Fresino V003
Cutter V003
Fräser V003
Fraise V003
Fresa V003

OPZ04873B
Morsetto A02
Jaw A02
Spannbacke A02
Étau A02
Mordaza A02

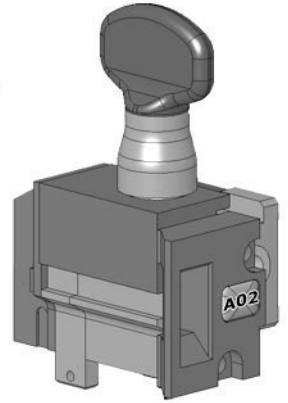

STANDARD



2.5 mm

RIC01810B
Fresino HC011
Cutter HC011
Fräser HC011
Fraise HC011
Fresa HC011



RIC01811B
Tastatore C011
Tracer Point C011
Taster C011
Palpeur C011
Palpador C011



303/304/305



**T-REX
T-REX ADVANCE**



PUNTO



994 LASER



ZAD30U

OPZ03182B
Morsetto A-994
Jaw A-994
Spannbacke A-994
Étau A-994
Mordaza A-994
STANDARD



OPZ09329B
Adattatore AV08
Adaptor AV08
Adapter AV08
Adaptateur AV08
Adaptador AV08
OPTIONAL

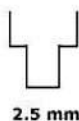

2.5 mm



RIC05304B
Fresino WC011A
Cutter WC011A
Fräser WC011A
Fraise WC011A
Fresa WC011A
STANDARD

OPZ09734B
Morsetto A/C - 997
Jaw A/C - 997
Spannbacke A/C - 997
Étau A/C - 997
Mordaza A/C - 997
STANDARD

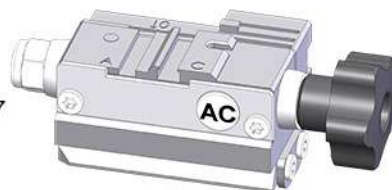

OPZ09329B
Adattatore AV08
Adaptor AV08
Adapter AV08
Adaptateur AV08
Adaptador AV08
OPTIONAL

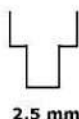

2.5 mm



RIC05304B
Fresino WC011A
Cutter WC011A
Fräser WC011A
Fraise WC011A
Fresa WC011A
STANDARD



NINJA LASER



ZAD30U



NINJA VORTEX



VERSA



NINJA TOTAL



OPZ09329B
Adattatore AV08
Adaptor AV08
Adapter AV08
Adaptateur AV08
Adaptador AV08
OPTIONAL

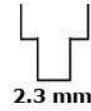

2.3 mm



RIC05506B
Fresino V016
Cutter V016
Fräser V016
Fraise V016
Fresa V016
OPTIONAL

OPZ04871B
Morsetto A01
Jaw A01
Spannbacke A01
Étau A01
Mordaza A01
STANDARD
 (VERSION 4 JAWS)

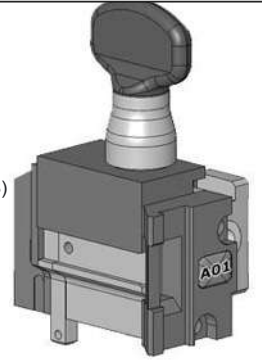

OPZ09329B
Adattatore AV08
Adaptor AV08
Adapter AV08
Adaptateur AV08
Adaptador AV08
OPTIONAL

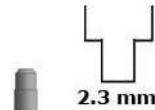

2.3 mm



RIC05506B
Fresino V016
Cutter V016
Fräser V016
Fraise V016
Fresa V016
OPTIONAL

OPZ10569B
Morsetto C30
Jaw C30
Spannbacke C30
Étau C30
Mordaza C30
STANDARD

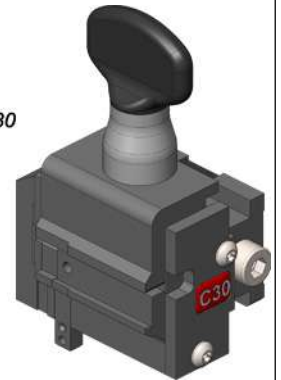

CHIAVI PATENT / CHIAVI A DOPPIA MAPPA E POMPA

COLD FORGED KEYS / DOUBLE BIT AND PUMP KEYS

PATENTSCHLÜSSEL / DOPPELBART - PUMPENSCHLÜSSEL

CLÉS PATENT / CLÉS À DOUBLE PANNETON ET À POMPE

LLAVES PATENT / LLAVES A DOBLE PALETÓN Y POMPA

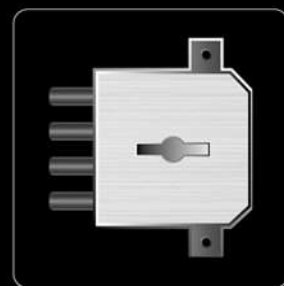

TO FIT: **CHIAVI FERMO POSTERIORE - BACK STOP BIT KEYS**

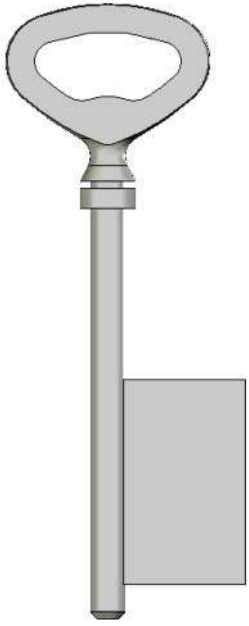

**POWER LYNX
SIGMA PRO**

OPTIONAL

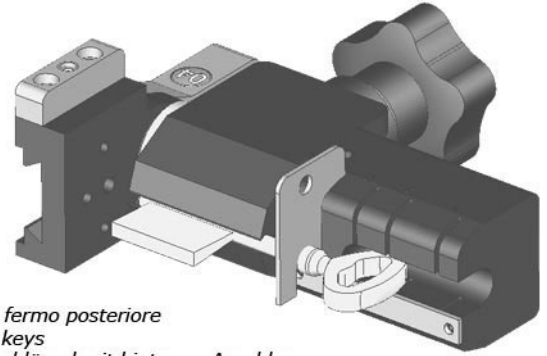

OPZ04701B

*Morsetto per chiavi a fermo posteriore
Jaw for back stop bit keys
Spannbacke für Bartschlüssel mit hinterem Anschlag
Étau pour clés panneton à butee derriere
Mordaza para llaves de pala con tope posterior*

TO FIT: **TOVER (E)**



**POWER LYNX
SIGMA PRO**

OPTIONAL

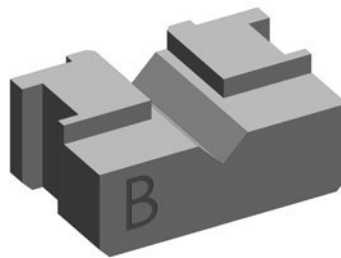

OPZ08313B

*Ganascia B per Tover
Vice B for Tover
Schraubstock B für Tover
Mâchoire B pour Tover
Morsa B para Tover*

TO
FIT :

FIAM (I)

OPTIONAL

OPZ04089B

Adattatore per chiavi gambo quadro
Adaptor for stem squared keys
Adapter für schlüssel mit viereckiger schaft
Adaptateur pour clés avec tige carrée
Adaptador para llaves con vástago cuadrado

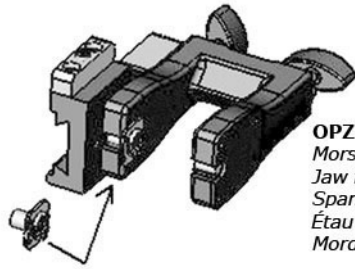
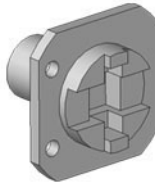

OPZ04061B

Morsetto per chiavi mappa fermo anteriore
Jaw for front stop bit keys
Spannbacke für bartschlüssel mit vorderem anschlag
Étau pour clés panneton à butée avant
Mordaza para llaves de pala con tope anterior



**POWER LYNX
SIGMA PRO**

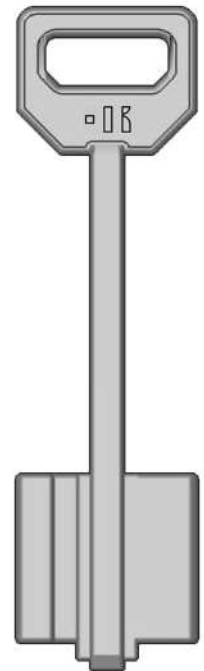

15FIA

TO
FIT :

KROMER (D)

OPTIONAL

OPZ05033B

Morsetto 06 per chiavi Germania
Jaw 06 for Germany keys
Spannbacke 06 für Deutschland-Schlüssel
Étau 06 pour clés Allemaïne
Mordaza 06 para llaves Alemania

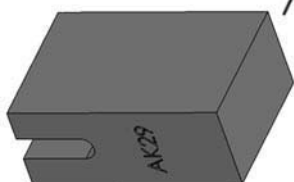
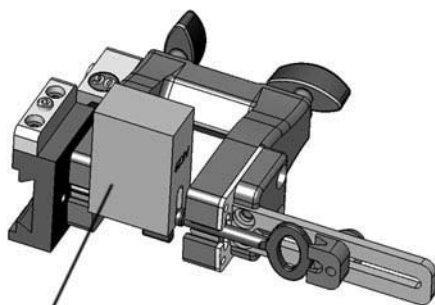

OPZ05233B

Adattatore 06 per chiavi Germania
Adaptor 06 for Germany keys
Adapter 06 für Deutschland-Schlüssel
Adaptateur 06 pour clés Allemaïne
Adaptador 06 para llaves Alemania



**POWER LYNX
SIGMA PRO**

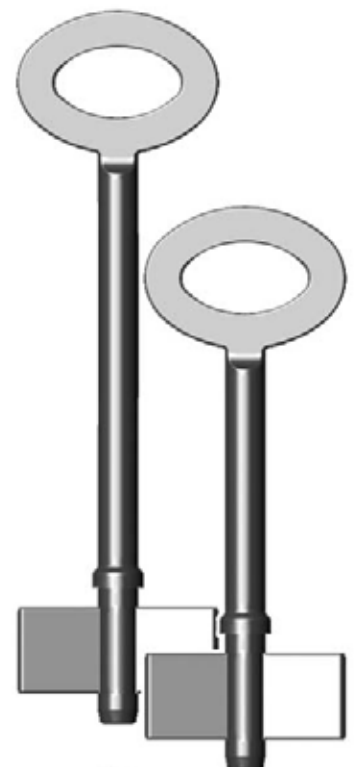

LONG SHORT

TO FIT: **CHIAVI MAPPA - GERMANY KEYS**

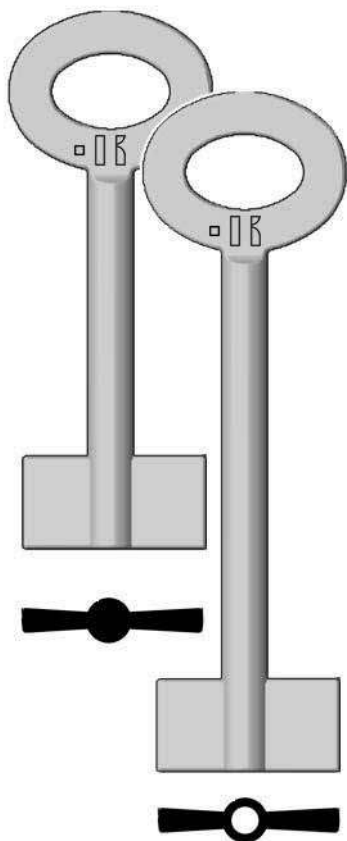

**POWER LYNX
SIGMA PRO**

OPTIONAL

OPZ05033B

*Morsetto 06 per chiavi Germania
Jaw 06 for Germany keys
Spannbacke 06 für Deutschland-Schlüssel
Étau 06 pour clés Allemaine
Mordaza 06 para llaves Alemania*

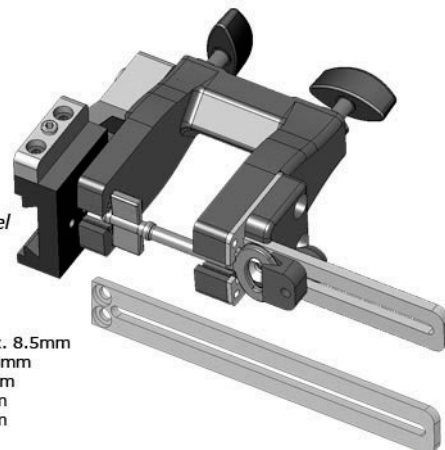

Gambo chiave Ø min. 5mm max. 8.5mm
Key stem Ø min. 5mm max. 8.5mm
Rücken Ø min. 5mm max. 8.5mm
Canon Ø min. 5mm max. 8.5mm
Cañon Ø min. 5mm max. 8.5mm

TO FIT: **CHIAVI FERMO CENTRALE - MORTICE KEYS**

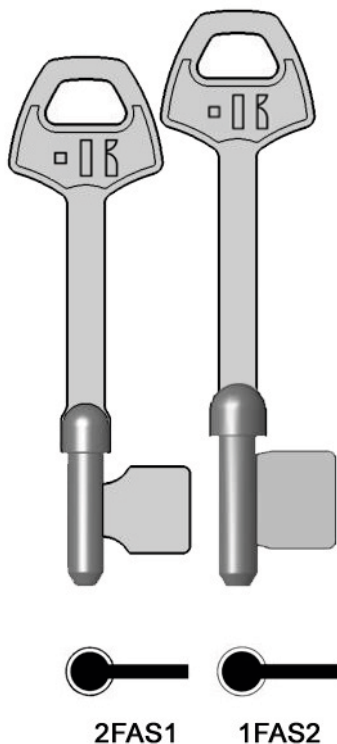

**POWER LYNX
SIGMA PRO**

OPTIONAL

OPZ04057B

*Morsetto chiavi a mappa fermo centrale
Jaw for mortice keys
Spannbacke für Schlüssel mit Anschlag in der mitte
Étau pour clés panneton à butée centrale
Mordaza para llaves de pala con tope central*

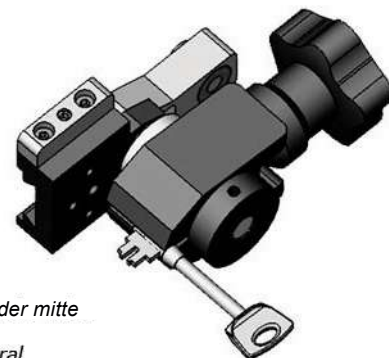

STANDARD



206

TO
FIT :

PATENT

OPTIONAL

CTV

*Carrello tagli verticali
Carriage for vertical cuts
Nutenschneider
Chariot pour coupes verticales
Carro para los cortes verticales*



T/CTV

*Tastatore per carrello CTV
Tracer Point for carriage CTV
Taster für Nutenschneider CTV
Palpeur pour le chariot CTV
Palpador para el carro CTV*



202



203

STANDARD



204

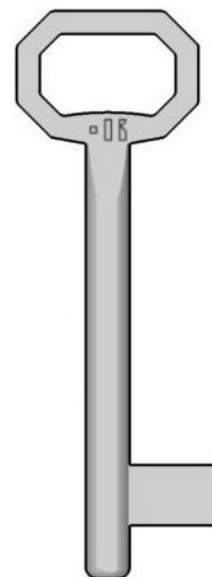

PAT1

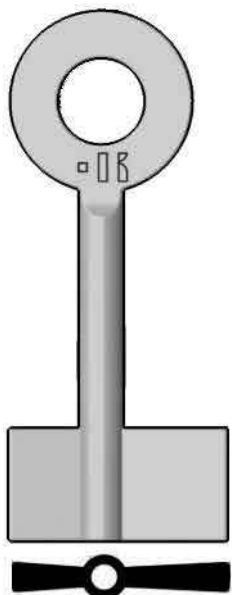

FCF70PA

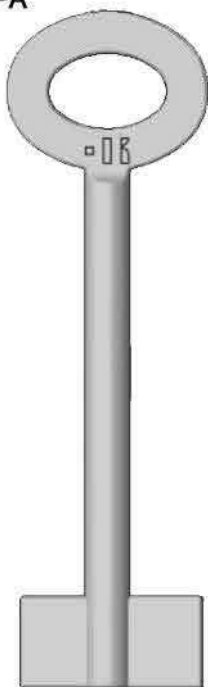

FCF88CO



FCF455



POWER LYNX



SIGMA PRO

OPTIONAL

OPZ04353B

*Set contropunte per chiavi femmina e chiavi corte
Tailstocks set for pipe and short keys
Reitstock für gebohrt-und Kurzschlüssel
Contrepoints pour clés femelles et courtes
Contrapuntas para llaves hembras y cortas*

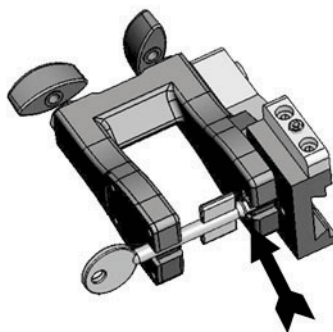
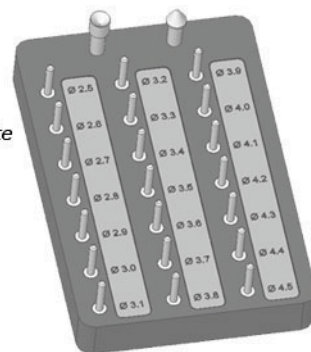

OPZ04061B

*Morsetto per chiavi mappa fermo anteriore
Jaw for front stop bit keys
Spannbacke für bartschlüssel mit vorderem anschlag
Étau pour clés panneton à butée avant
Mordaza para llaves de pala con tope anterior*

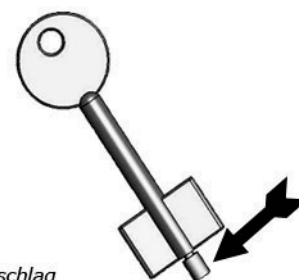

OPZ04403B

*Contropunta per chiavi femmina e chiavi corte
Tailstock for pipe and short keys
Reitstock für gebohrt und Kurzschlüssel
Contrepoint pour clés femelles et courtes
Contrapunta para llaves hembras y cortas
STANDARD*

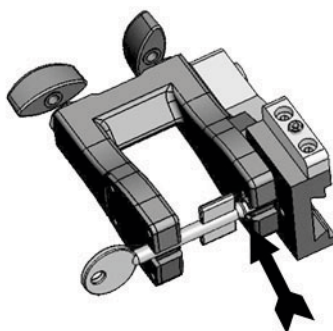

OPZ04061B

*Morsetto per chiavi mappa fermo anteriore
Jaw for front stop bit keys
Spannbacke für bartschlüssel mit vorderem anschlag
Étau pour clés panneton à butée avant
Mordaza para llaves de pala con tope anterior*

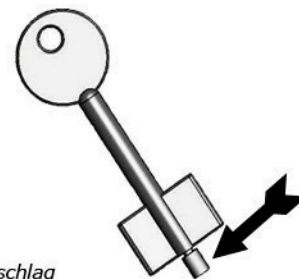

OPTIONAL

TO
FIT :

CHIAVI A POMPA - PUMP KEYS

OPTIONAL

OPZ03014B

Morsetto chiavi a pompa
Jaw for pump keys
Spannbacke für Pumpenschüssel
Étau pour clés à pompe
Mordaza para llaves de bomba

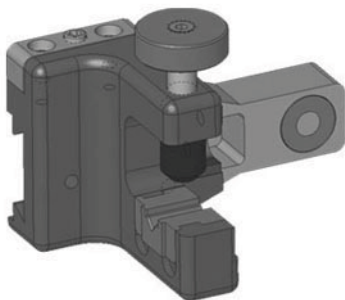

**POWER LYNX
SIGMA PRO**

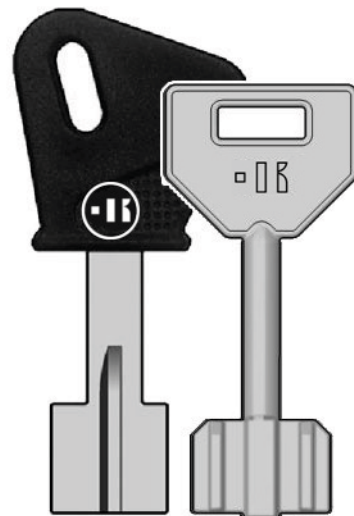

MO-FP
MO-AP
MO-CP
MO-EP
MO-GP



3FEB

TO
FIT :

SANS SOUCI (F)

OPTIONAL

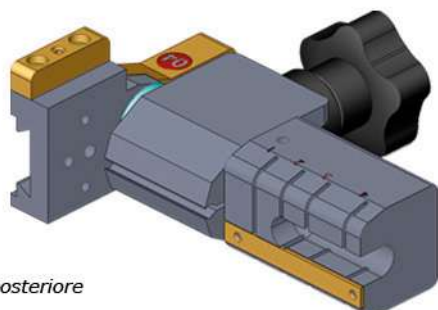

OPZ04701B

Morsetto per chiavi a mappa fermo posteriore
Jaw for back stop bit keys
Spannbacke für Bartschüssel mit hinterem Anschlag
Étau pour clés panneton à butée derrière
Mordaza para llaves de pala con tope posterior



**POWER LYNX
SIGMA PRO**

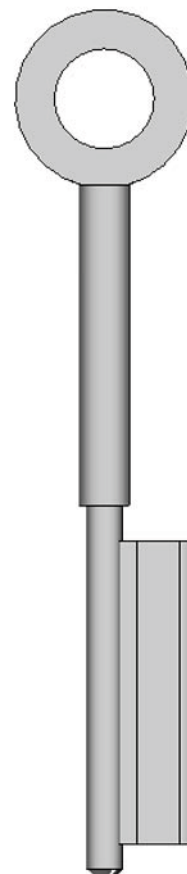

CHIAVI A CROCE / PER CASELLARI POSTALI / TUBOLARI

CRUCIFORM KEYS / MAIL BOX KEYS / TUBULAR KEYS

KREUZBARTSCHLÜSSEL / POSTFACHSCHLÜSSEL / STECKSCHLÜSSEL

CLÉS A CRUCIFORMES / POUR CASIERS POSTAUX / TUBULAIRES

LLAVES A CRUZ / PARA CASILLAS POSTALES / TUBULARES



TO
FIT :

BILMA (E)

OPTIONAL

OPZ08575B

Morsetto KT0
Jaw KT0
Spannbacke KT0
Étau KT0
Mordaza KT0

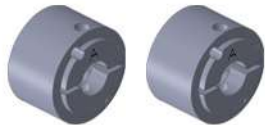

OPZ09448B

Adattatori modello A per chiavi Ø=10 mm
Adaptors model A for keys Ø=10 mm
Adapters model A für Schlüssel Ø=10 mm
Adaptateurs catégorie A pour clés Ø=10 mm
Adaptadores modelo/tipo A para llaves Ø=10 mm



ARCADIA

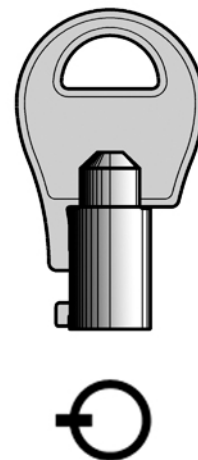

TO
FIT :

CAVITH (F)

OPTIONAL

OPZ08573B

Morsetto KT13 per Cavith
Jaw KT13 for Cavith
Spannbacke KT13 für Cavith
Étau KT13 pour Cavith
Mordaza KT13 para Cavith



ARCADIA

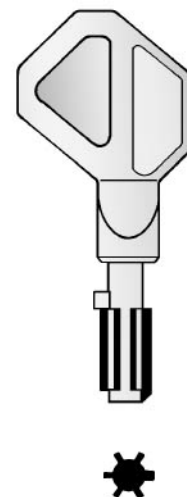

TO FIT: **CHIAVI A CROCE - CRUCIFORM KEYS**

STANDARD

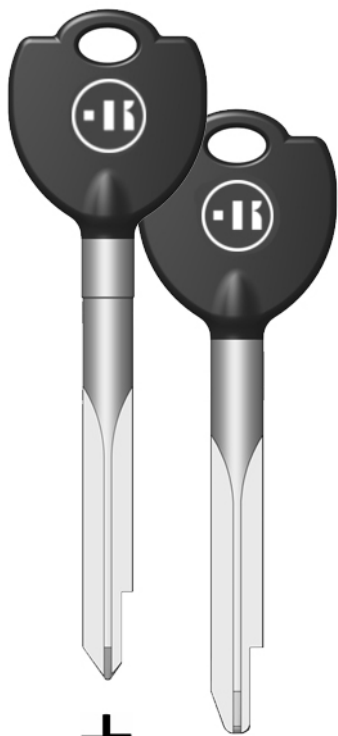

+
XBU2P
XBU3P

+
XYE1P



NINJA TOTAL



CARAT/106



**101/102
103/104**



105



**EURO/ECO
EASY/LUPO**



**NINJA
NINJA DARK**

TO FIT : **CHIAVI PER CASELLARI POSTALI (USA) - MAIL BOX KEYS (USA)**

OPTIONAL

OPZ05309B

Set per chiavi casellari postali USA
 Mail box key set USA
 USA Postfachschlüsselsatz
 Set pour clés casiers postaux USA
 Set de llaves para casillas postales USA

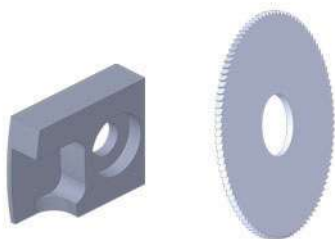

CARAT/106

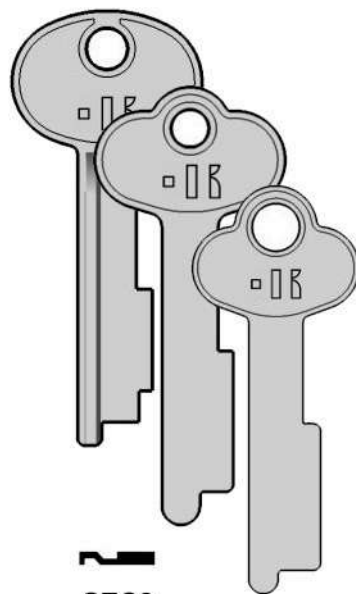

SEC2

YOR2

DIE3

STANDARD



206

TO FIT : **DAD-DECAYEUX (F)**

OPTIONAL

OPZ08888B

Morsetto KT7 per FTH/Dad-Decayeux
 Jaw KT7 for FTH/Dad-Decayeux
 Spannbacke KT7 für FTH/Dad-Decayeux
 Étau KT7 pour FTH/Dad-Decayeux
 Mordaza KT7 para FTH/Dad-Decayeux



ARCADIA



TO
FIT: FTH (F)

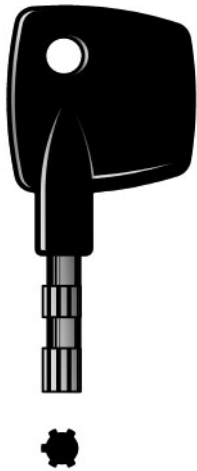

ARCADIA

OPTIONAL

OPZ08888B

*Morsetto KT7 per FTH/Dad-Decayeux
Jaw KT7 for FTH/Dad-Decayeux
Spannbacke KT7 für FTH/Dad-Decayeux
Étau KT7 pour FTH/Dad-Decayeux
Mordaza KT7 para FTH/Dad-Decayeux*



TO
FIT: JPM (F)

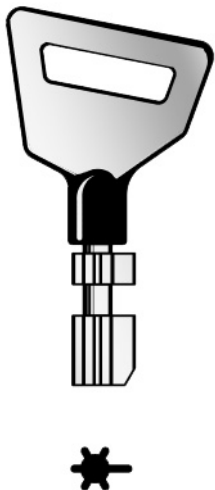

ARCADIA

OPTIONAL

OPZ08885B

*Morsetto KT6 per JPM
Jaw KT6 for JPM
Spannbacke KT6 für JPM
Étau KT6 pour JPM
Mordaza KT6 para JPM*



TO
FIT :

LAPERCHE (F)

OPTIONAL

OPZ08558B

Morsetto KT5 per Laperche
Jaw KT5 for Laperche
Spannbacke KT5 für Laperche
Étau KT5 pour Laperche
Mordaza KT5 para Laperche



ARCADIA

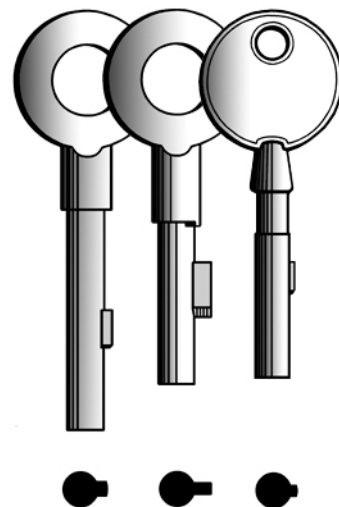

TO
FIT :

POLLUX (F)

OPTIONAL

OPZ08568B

Morsetto KT8 per Pollux
Jaw KT8 for Pollux
Spannbacke KT8 für Pollux
Étau KT8 pour Pollux
Mordaza KT8 para Pollux



ARCADIA

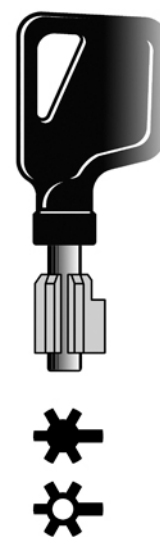

TO
FIT: POLLUX (F)

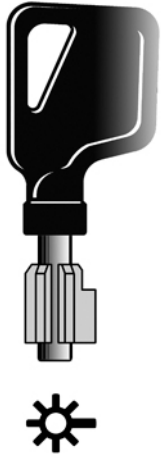

ARCADIA

OPTIONAL



OPZ08579B
Morsetto KT9 per Pollux
Jaw KT9 for Pollux
Spannbacke KT9 für Pollux
Étau KT9 pour Pollux
Mordaza KT9 para Pollux

TO
FIT: PROGRES FONTAINE (F) - CORNI (I)

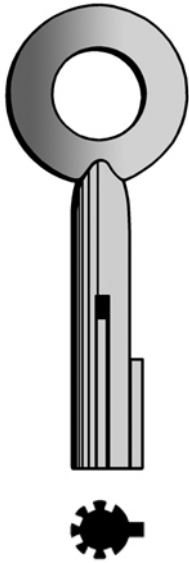

ARCADIA

OPTIONAL



OPZ08575B
Morsetto KT3 per Progres Fontaine / Corni
Jaw KT3 for Progres Fontaine / Corni
Spannbacke KT3 für Progres Fontaine / Corni
Étau KT3 pour Progres Fontaine / Corni
Mordaza KT3 para Progres Fontaine / Corni

- * 8 Posizioni
- * 8 Positions
- * 8 Positionen
- * 8 Positions
- * 8 Posiciones

TO
FIT :

PROGRES FONTAINE (F) - CORNI (I)

OPTIONAL



OPZ08620B

Morsetto KT2 per Progres Fontaine/Corni
Jaw KT2 for Progres Fontaine/Corni
Spannbacke KT2 für Progres Fontaine/Corni
Étau KT2 pour Progres Fontaine/Corni
Mordaza KT2 para Progres Fontaine/Corni



ARCADIA

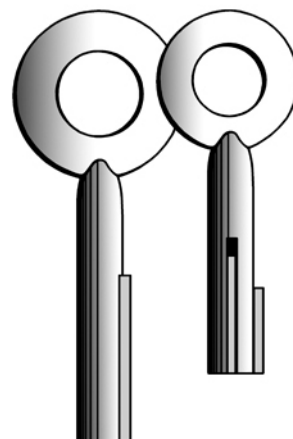

* 6 Posizioni
* 6 Positions
* 6 Positionen
* 6 Positions
* 6 Posiciones

TO
FIT :

CHIAVI TUBOLARI - TUBULAR KEYS

OPTIONAL

MT

Morsetti per chiavi tubolari
Jaws for tubular keys
Spannbacken für Steckschlüssel
Étaux pour clés tubulaires
Mordazas para llaves tubulares

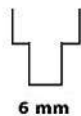

6 mm

RIC01818B
Fresino HC131
Cutter HC131
Fräser HC131
Fraise HC131
Fresa HC131



RIC01819B
Tastatore C131
Tracer Point C131
Taster C131
Palpeur C131
Palpador C131



303/304/305

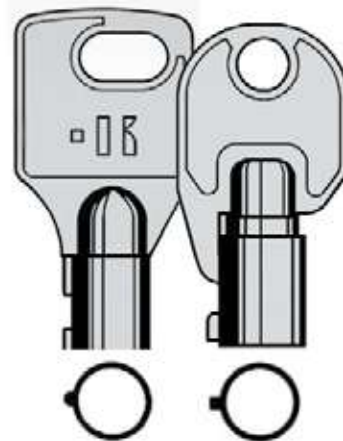

OPTIONAL

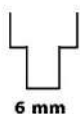

6 mm

RIC01818B
Fresino HC131
Cutter HC131
Fräser HC131
Fraise HC131
Fresa HC131

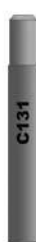

RIC01819B
Tastatore C131
Tracer Point C131
Taster C131
Palpeur C131
Palpador C131



**T-REX
T-REX ADVANCE**



TO FIT: **CHIAVI TUBOLARI - TUBULAR KEYS**

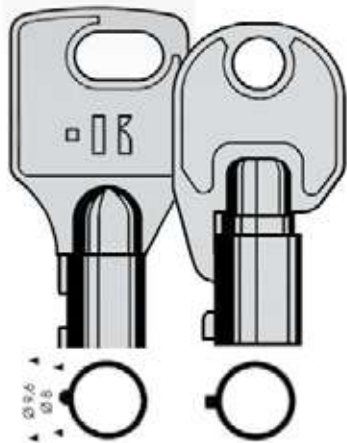

ME17T



ME18T



ARCADIA

OPTIONAL

OPZ09216B

Morsetto KT0 per Meroni e Chicago
 Jaw KT0 for Meroni and Chicago
 Spannbacke KT0 für Meroni und Chicago
 Étau KT0 pour Meroni et Chicago
 Mordaza KT0 para Meroni y Chicago



TO FIT: **CHIAVI TUBOLARI - TUBULAR KEYS**

CHICAGO (USA)
 FORT (USA)
 KENSTAN (USA)
 L&F (GB)
 OGDEN (USA)
 RONIS (D) CH9T(9.60)
 MERONI (I) ME17T(9.60)
 ME18T(9.60)
 P.CORTELLAZZI (I) PC2T(9.60)



NINJA TOTAL



NINJA VORTEX

OPTIONAL



2.5 mm



RIC05048B
 Fresino V003
 Cutter V003
 Fräser V003
 Fraise V003
 Fresa V003

OPZ10677B

Morsetto C34
 Jaw C34
 Spannbacke C34
 Étau C34
 Mordaza C34

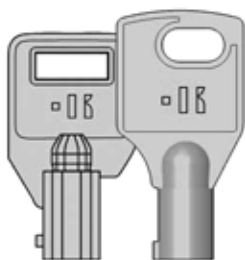

PC1T

ME17T
 ME18T

BILMA (E)
 AGA(E)



TO
FIT :

VIGIE PICARD (F)

OPTIONAL

OPZ08582B

*Morsetto KT4 per Vigie Picard
Jaw KT4 for Vigie Picard
Spannbacke KT4 für Vigie Picard
Étau KT4 pour Vigie Picard
Mordaza KT4 para Vigie Picard*



ARCADIA

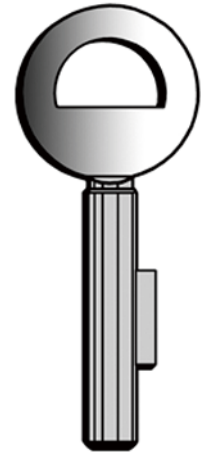

TO
FIT :

CHIAVI A Y - Y KEYS

OPTIONAL

MY

*Morsetti per chiavi a Y
Jaws for Y keys
Spannbacken für Y - Schlüssel
Étau pour clés à Y
Mordazas para llaves Y*



CARAT/106



**101/102
103/104**



**EURO/ECO
EASY/LUPO**

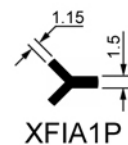
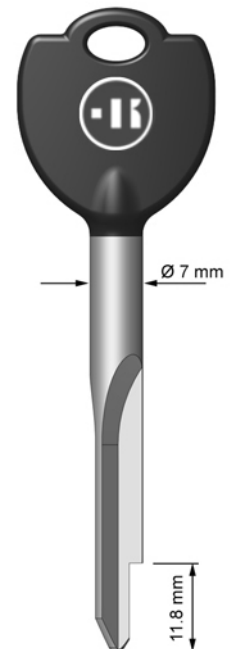

ACCESSORI GENERICI OPZIONALI

OPTIONAL GENERIC ACCESSORIES

OPTIONAL ALLGEMEINE ZUBEHÖRE

ACCESSOIRES VARIÉS OPTIONAUX

ACCESORIOS GENÉRICOS OPCIONALES

OPZ02600B

Morsetti basculanti 304
 Tilting Jaws 304
 Schwenkbare-Spannbacken 304
 Étaux basculantes 304
 Mordazas basculantes 304

**303****OPZ05017B**

Kit completo UK Aspirazione per 994 Laser
 Complete UK Vacuum Kit for 994 Laser
 Komplette UK Saugen Kit AK29 für 994 Laser
 Kit complète UK de Aspiration pour 994 Laser
 Kit completo UK de Aspiración para 994 Laser

OPZ05013B

Kit completo USA-Japan Aspirazione per 994 Laser
 Complete USA-Japan Vacuum Kit for 994 Laser
 Komplette USA-Japan Saugen Kit AK29 für 994 Laser
 Kit complète USA-Japan de Aspiration pour 994 Laser
 Kit completo USA-Japan de Aspiración para 994 Laser

OPZ05015B

Kit completo EU Aspirazione per 994 Laser
 Complete EU Vacuum Kit for 994 Laser
 Komplette EU Saugen Kit AK29 für 994 Laser
 Kit complète EU de Aspiration pour 994 Laser
 Kit completo EU de Aspiración para 994 Laser

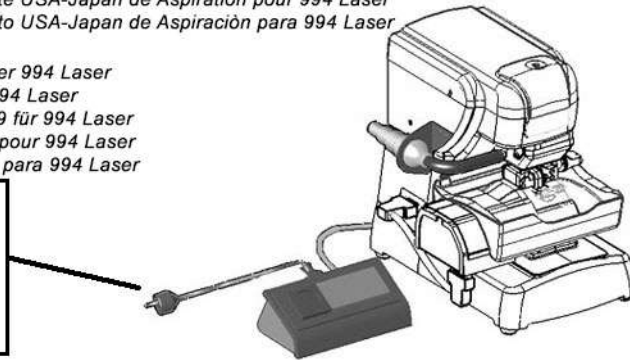
**994 LASER****OPZ04219B**

Kit Aspirazione per 994 Laser
 Vacuum Kit for 994 Laser
 Saugen Kit AK29 für 994 Laser
 Kit de Aspiacion pour 994 Laser
 Kit de Aspiración para 994 Laser

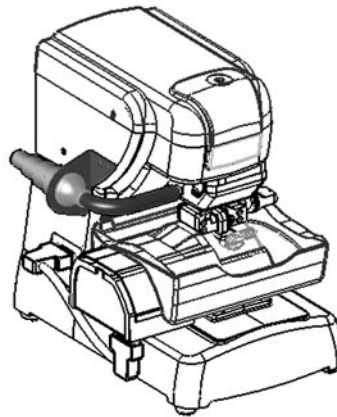
**994 LASER****OPZ08462B**

Morsetto F per chiavi piatte
 Jaw F for edge-cut keys
 Spannbacke F für Flachschlüssel
 Étau F pour clés plates
 Mordaza F para llaves planas

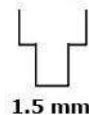
**RIC08409B**

Fresino per morsetto F
 Cutter for Jaw F
 Fräser für Spannbacke F
 Fraise pour Étau F
 Fresa para Mordaza F

**RIC08410B**

Tastatore TL002
 Tracer Point TL002
 Taster TL002
 Palpeur TL002
 Palpador TL002

**994 LASER WITH OLD CONSOLE**



994 LASER

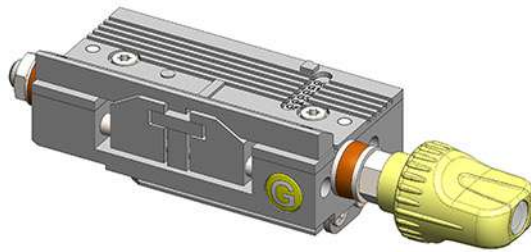

OPZ09486B
 Morsetto G per chiavi piatte
 Jaw G for edge-cut keys
 Spannbacke G für Flachschlüssel
 Étau G pour clés plates
 Mordaza G para llaves planas

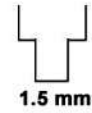

RIC09617B
 Fresino CL005
 Cutter CL005
 Fräser CL005
 Fraise CL005
 Fresa CL005

RIC09483B
 Tastatore TL003
 Tracer Point TL003
 Taster TL003
 Palpeur TL003
 Palpador TL003



NINJA VORTEX

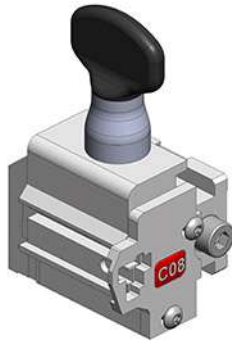

OPZ06039B
 Morsetto C08 per chiavi piatte
 Jaw C08 for edge-cut keys
 Spannbacke C08 für Flachschlüssel
 Étau C08 pour clés plates
 Mordaza C08 para llaves planas



OPZ06377B
 Tastatore T003
 Tracer T003
 Taster T003
 Palpeur T003
 Palpador T003



VERSA



DEZMO

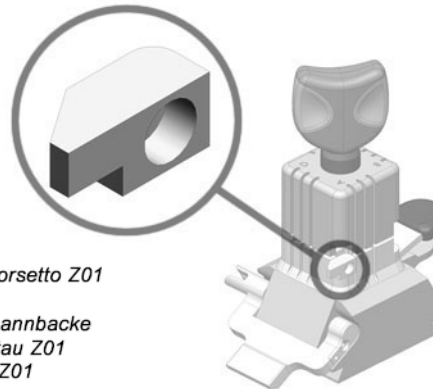

OPZ08727B
 Dispositivo antiribaltamento per morsetto Z01
 Anti-rollover tool for Z01 jaw
 Anti-Überroll Werkzeug für Z01 Spannbacke
 Dispositif anti-reversament pour étau Z01
 Dispositivo antigiro para mordaza Z01

OPZ09874B

Fermo Punta Magnetico per morsetti Ninja
Magnetic tip-stop for Ninja jaw
Magnetischer Tippanschlag für Ninja Spannbacke
Cale de butée magnétique pour étau Ninja
Tope magnético para mordaza Ninja

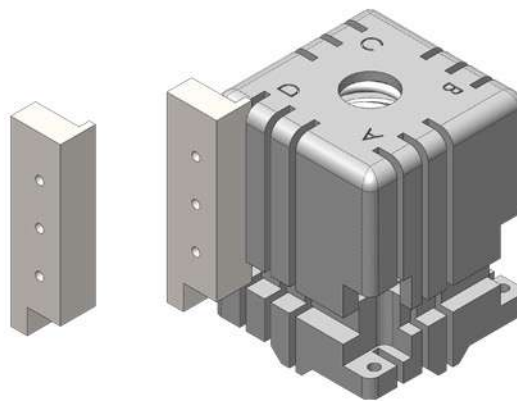

NINJA LASER



NINJA TOTAL



**NINJA
NINJA DARK**

OPZ10596B

Dispositivo antiribaltamento per morsetti Ninja
Anti-rollover tool for Ninja jaw
Anti-Überroll Werkzeug für Ninja Spannbacke
Dispositif anti-reversament pour étau Ninja
Acessorio antigiro para mordaza Ninja

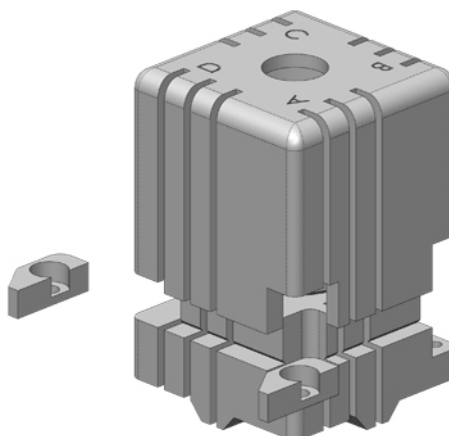

NINJA LASER



NINJA TOTAL

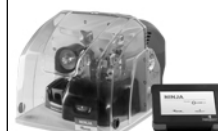

**NINJA
NINJA DARK**

GUIDA VELOCE AI SISTEMI CHIAVI LASER

QUICK GUIDE TO LASER KEY SYSTEMS

KURZANLEITUNG FÜR LASER-SCHLÜSSEL SYSTEME

GUIDE RAPIDE DES SYSTEMES DE CLÉS LASER

GUÍA RÁPIDA A LOS SISTEMAS LLAVES LÁSER

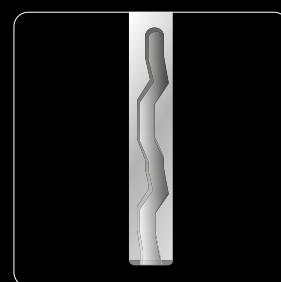

QUICK GUIDE TO LASER KEY SYSTEMS

994 LASER | NINJA LASER | NINJA TOTAL CAR KEYS

MAKE	KEY SYSTEM	SERIES	KL REFERENCE	994 LASER			NINJA LASER			NINJA TOTAL		
				Jaw	Adaptor	Cutter	Jaw	Adaptor	Cutter	Jaw	Adaptor	Cutter
ABARTH	2ITL 8	(.....) ABCD DE00001-DE11210	FT22U	C		WC011A	AC		WC011A	A03		V003
ACURA	4ET 6+6	H001-N718 K001-N718	HD1U	A		WC011A	AC		WC011A	C30		V003
	4IT 5+5	12345	ORIGINAL	B		WC011A	B		WC011A	A02		V003
ALFA ROMEO	2ITL 8	(.....) ABCD DE00001-DE11210	FT22U	C		WC011A	AC		WC011A	A03		V003
ASTON MARTIN	2ETR 10	01-3022 H1-H3000 WH1-WH3000	VX4P	A		WC011A	AC		WC011A	C30		V003
AUDI	2ITL 8	1-6000 EXT 6001-8100 EXT HAA0001-8110 EXT HAA6001-8110 NAA0001-8110 EXT NAA6001-8110	AD66U	C		WC011A	AC		WC011A	A03		V003
		0001-6000 6001-8100 1ATS1-1ATS17850 HAA0001-2000 HAA0001-6000 HAA0001-8110 NAA0001-2000 NAA0001-8110	AD66U	C		WC011A	AC		WC011A	A03		V003
BMW	2ITL 8	HF000001-HF004001 Z0001-Z1000	ORIGINAL	C		WC011A	AC		WC011A	A03		V003
	2ITR 8	0001-8100	BM2U	C		WC011A	AC		WC011A	A03		V003
	4ET 6+6	BH010001-BH241450	HU58P	B		WC011A	B		WC011A	A02		V003
BUICK	2ITR 8	Z0001-Z2000 Z0001-Z6000 Z0001-Z6314 Z2001-Z4000	VX5U	C		WC011A	AC		WC011A	A03		V003
CADILLAC	2ITR 8	Z0001-Z2000 Z0001-Z6000 Z2001-Z4000 Z4001-Z6314	VX5U	C		WC011A	AC		WC011A	A03		V003
	2ITR 10	V0001-V6000	VX5U	A C		WC011A WC011A	AC		WC011A	A03		V003
CHEVROLET	2ITR 8	0001-3679 Z0001-Z6000	ORIGINAL	C		WC011A	AC		WC011A	A03		V003
		Z0001-Z2000 Z2001-Z4000 Z4001-Z6314	VX5U	C		WC011A	AC		WC011A	A03		V003
	2ITR 10	V0001-V5718 V0001-V6000	ORIGINAL VX5U	C C		WC011A WC011A	AC AC		WC011A WC011A	A03 A03		V003 V003
CHRYSLER	2ETL 10 ROUND	1002001-1003200	MB41P	D		WC011A	D		WC011A	A04		V003
	2ETL FLAT 10	0001-0355 3501-6700 1003501-1006700	MB57P	D		WC011A	D		WC011A	A04		V003
CITROËN	2ITR 7 LARGE	1-2000 HCA0001-HCA2000 HO0HCA1-HO0HCA2000	PG83U	C		WC011A	AC		WC011A	A03		V003
DODGE	2ETL FLAT 10	3501-6700	MB57P	D		WC011A	D		WC011A	A04		V003
EUNOS	4IT 8+8	20001-21200	ORIGINAL	A		WC011A	AC		WC011A	C30		V003
FIAT	2ITL 8	(.....) ABCD DE00001-DE11210	FT22U	C		WC011A	AC		WC011A	A03		V003
	2ITR 7 LARGE	1-2000 HCA0001-HCA2000	PG83U	C		WC011A	AC		WC011A	A03		V003
FORD (AUSTRALIA)	2ETR 10	0001-4000	FD40U	A		WC011A	AC		WC011A	C30		V003
FORD (EUROPE)	2ETR 10	0001-4000	FD40U	A		WC011A	AC		WC011A	C30		V003

QUICK GUIDE TO LASER KEY SYSTEMS

994 LASER | NINJA LASER | NINJA TOTAL CAR KEYS

MAKE	KEY SYSTEM	SERIES	KL REFERENCE	994 LASER			NINJA LASER			NINJA TOTAL		
				Jaw	Adaptor	Cutter	Jaw	Adaptor	Cutter	Jaw	Adaptor	Cutter
FORD (EUROPE)	2ITL 8	DE00001-DE11210	FT22U	C		WC011A	AC		WC011A	A03		V003
		HAA0001-8110	AD66U	C		WC011A	AC		WC011A	A03		V003
FORD (USA)	2ETR 7	11501-13000	FD40U	A		WC011A	AC		WC011A	C30		V003
	2ETR 10	0001-4000 10001-11500 10001-14514 14515-15014	FD40U	A		WC011A	AC		WC011A	C30		V003
GENESIS	4IT 4+3	X0001-X2245	TR49U	A		WC011A	AC		WC011A	C30		V003
	4IT 4+3 SLIM	I0001-I2608	ORIGINAL	A	AD03	WC011A	AC	AD03	WC011A	C30	AD03	V003
GMC	2ITR 8	Z0001-Z6000	VX5U	C		WC011A	AC		WC011A	A03		V003
	2ITR 10	V0001-V5718 V0001-V6000	VX5U	C		WC011A	AC		WC011A	A03		V003
HOLDEN	2ETR 10	H1-H3000 M1-M3000 WH1-WH3000	VX4U	A		WC011A	AC		WC011A	C30		V003
		WY1-WY3000 Y1-Y3000	VX3U	A		WC011A	AC		WC011A	C30		V003
	2ITR 8	Z0001-Z6314	VX5U	C		WC011A	AC		WC011A	A03		V003
HONDA	4ET 6+6	0H001-0N718 0K001-0N718 (A/Z)H001-N718 (A/Z)K001-N718 H001-N718 K001-N718	HD1U	A		WC011A	AC		WC011A	C30		V003
	4IT 5+5	12345	ORIGINAL	B		WC011A	B		WC011A	A02		V003
HYUNDAI	2ITL 8	1001-3500 T1001-T3500 X1001-3500	HY21U	A		WC011A	AC		WC011A	C30		V003
		5001-6616	HY20U	C		WC011A	AC		WC011A	A03		V003
		B0001-B3000	ORIGINAL	A		WC011A	AC		WC011A	C30		V003
	2ITR 8	C1001-C3500	ORIGINAL	A		WC011A	AC		WC011A	A03		V003
	4IT 6+6	G0001-G2500 HK1-HK2500 J0001-J2500 K0001-K2500 T1-T2500	TR49U	A		WC011A	AC		WC011A	C30		V003
	4IT SLIM 4+3	B0001-B2608 I0001-I2608 X0001-X2245	ORIGINAL	A	AD03	WC011A	AC	AD03	WC011A	C30	AD06	V003
INFINITI	4ET 5+5	0001-2000 2001-6000	ORIGINAL	A	AD02	WC011A	AC	AD02	WC011A	C30	AV01	V003
JEEP	2ITL 8	DE00001-DE11210	FT22U	C		WC011A	AC		WC011A	A03		V003
KIA	2ETL 7	0001-2300	ORIGINAL	A		WC011A	AC		WC011A	C30		V003
	2ITL 8	B0001-B3000 D0001-D3000	ORIGINAL	A		WC011A	AC		WC011A	C30		V003
		C0001-C2900 KC001-KC2500 TB1001-3500	ORIGINAL	A		WC011A	AC		WC011A	C30		V003
	2ITR 8	UM1001-UM3500	ORIGINAL	A		WC011A	AC		WC011A	A03		V003
	4IT 4+3	KU0001-KU2608 U0001-U2500	TR49U	A		WC011A	AC		WC011A	C30		V003
	4IT 6+6	E1-E2500 G0001-G2500 K0001-K2500 KE0001-KE2500 KG1-KG2500 T1-T2500 V0001-V2500	TR49U	A		WC011A	AC		WC011A	C30		V003
4IT 8+8	L0001-L1037	KI4		A		WC011A	AC		WC011A	C30		V003
	L1-L1037	TR49U		A		WC011A	AC		WC011A	C30		V003

QUICK GUIDE TO LASER KEY SYSTEMS

994 LASER | NINJA LASER | NINJA TOTAL CAR KEYS

MAKE	KEY SYSTEM	SERIES	KL REFERENCE	994 LASER			NINJA LASER			NINJA TOTAL		
				Jaw	Adaptor	Cutter	Jaw	Adaptor	Cutter	Jaw	Adaptor	Cutter
KIA	4IT SLIM 4+3	I0001-I2608	ORIGINAL	A	AD03	WC011A	AC	AD03	WC011A	C30	AD06	V003
LANCIA	2ITL 8	(.....) ABCD DE00001-DE11210	FT22U	C		WC011A	AC		WC011A	A03		V003
LAND ROVER	2ETR 10	0001-4000	FD40U	A		WC011A	AC		WC011A	C30		V003
	2ITR 8	00001-81000	BM22P	C		WC011A	AC		WC011A	A03		V003
	4ET 5+5	1-6000	ORIGINAL	B		WC011A	B		WC011A	A02		V003
LEXUS	4IT 4+4	80000-89999	ORIGINAL	A	AD03	WC011A	AC	AD03	WC011A	C30	AD06	V003
	4IT 5+5	40000-49999	TR48U	A		WC011A	AC		WC011A	C30		V003
	4IT 8+8	0001-5000 00001-05000	TR50P	A		WC011A	AC		WC011A	C30		V003
LINCOLN	2ETR 10	10001-11500	FD40U	A		WC011A	AC		WC011A	C30		V003
MAHINDRA	2ETR 10	12345 00001-03001	FD40U	A		WC011A	AC		WC011A	C30		V003
	2ITL 8	5001-6616	ORIGINAL	C		WC011A	AC		WC011A	A03		V003
MAZDA	4IT 8+8	20001-21200	ORIGINAL	A		WC011A	AC		WC011A	C30		V003
MERCEDES	2ET SHORT 10	(.....)12345	MB54P	D	AD05	WC011A	D	AD05	WC011A	A04		V003
	2ET-R ROUND 10	HA2001-HA3200 HA2501-HA3500 NA2001-NA3200 NA2501-NA3500	MB54P	D		WC011A	D		WC011A	A04		V003
	2ETL FLAT 10	0001-0355 3501-6700 1003501-1006700 210103210101-...200	MB57P	D		WC011A	D		WC011A	A04		V003
	2ETL LONG 13	HA10001-HA30057 NA10001-NA30057	MB58P	D		WC011A	D		WC011A	A04		V003
	4ET 8+8	2002001-2003500 700001-703000 HS2001-HS3500 NS2001-NS3500	MB53P	A		WC011A	AC		WC011A	C30		V003
MITSUBISHI	2ETR 8	00001-04000 DH0001-DH4000 DH6001-DH8000	VL15P	B		WC011A	B		WC011A	A02		V003
	4IT 8+8	30001-31200	TR49U	A		WC011A	AC		WC011A	C30		V003
NISSAN	4ET 5+5	0001-2000 2001-6000	ORIGINAL	A	AD02	WC011A	AC	AD02	WC011A	C30	AV01	V003
OPEL	2ETR 10	1-3022 HI-H3000 M1-M3000 WY1-WY3000 Y1-Y3000	VX3U	A		WC011A	AC		WC011A	C30		V003
	2ITR 8	1-3679 Z0001-Z2000 Z0001-Z6314 Z2001-Z4000 Z4001-Z6314	VX5U	C		WC011A	AC		WC011A	A03		V003
PEUGEOT	2ITL 6	ABCDEF	PG33U	C		WC011A	AC		WC011A	A03		V003
	2ITL 8	(.....) ABCD DE00001-DE11210	FT22U	C		WC011A	AC		WC011A	A03		V003
	2ITR 7 LARGE	1-2000 HCA0001-HCA2000 HOHCA1-HOHCA2000	PG83U	C		WC011A	AC		WC011A	A03		V003
	4ET 5+5	0123456789ABCDEF	PG31U	B		WC011A	B		WC011A	A02		V003
	4IT-T THIN 6	ABCDEF (0/Z 0/Z 0/Z 0/Z...) ABCDEF	PG33U	C		WC011A	AC		WC011A	A03		V003
PORSCHE	2ITL 8	01-06000 1-6000 1-6000 EXT 6001-8100 6001-8100 EXT HAA0001-8110	AD66U	C		WC011A	AC		WC011A	A03		V003

QUICK GUIDE TO LASER KEY SYSTEMS

994 LASER | NINJA LASER | NINJA TOTAL CAR KEYS

MAKE	KEY SYSTEM	SERIES	KL REFERENCE	994 LASER			NINJA LASER			NINJA TOTAL		
				Jaw	Adaptor	Cutter	Jaw	Adaptor	Cutter	Jaw	Adaptor	Cutter
RAM	2ITL 8	DE00001-DE11210	FT22U	C		WC011A	AC		WC011A	A03		V003
RANGE ROVER	2ETR 10	0001-4000	FD40AP	A		WC011A	AC		WC011A	C30		V003
	4ET 5+5	1-6000	ORIGINAL	B		WC011A	B		WC011A	A02		V003
RENAULT	2ITL 7	000001-992196	HY21U	A		WC011A	AC		WC011A	C30		V003
	2ITR 6	UC0001-UC1200	PG33U	A		WC011A	AC		WC011A	A03		V003
SAAB	2ETR 10	2S1-2S2675 BC1-BC2865	ORIGINAL	A		WC011A	AC		WC011A	C30		V003
	2ITL 7	DA1-DA2892	ORIGINAL	C		WC011A	AC		WC011A	A03		V003
	2ITL 8	DB1-DB4500	ORIGINAL	C		WC011A	AC		WC011A	A03		V003
	2ITR 8	Z0001-Z6314	VX5U	C		WC011A	AC		WC011A	A03		V003
SATURN	2ITR 8	Z0001-Z6000	VX5U	C		WC011A	AC		WC011A	A03		V003
SEAT	2ITL 8	HAA0001-8110	AD66U	C		WC011A	AC		WC011A	A03		V003
SMART	2ETR 8	DH0001-DH4000 DH6001-DH8000	ORIGINAL	B		WC011A	B		WC011A	A02		V003
	2ITL 6	1234Q5678H	PG33U	A		WC011A	AC		WC011A	A03		V003
SSANGYONG	4IT 6+6	KW1-KW2500	TR50P	A		WC011A	AC		WC011A	C30		V003
SUBARU	4ET 5+5	T0001-T3000	SUB1U	A		WC011A	AC		WC011A	C30		V003
TOYOTA	2ETR 10	H1-H3000 M1-M3000 WH1-WH3000	VX4P	A		WC011A	AC		WC011A	C30		V003
	2ITL 6	12897-A9999 B1085-B9547	PG33U	A		WC011A	AC		WC011A	A03		V003
	2ITL 8	025A1-WV6AG	ORIGINAL	A		WC011A	AC		WC011A	C30		V003
	4IT 4+4	80000-89999	ORIGINAL	A	AD03	WC011A	AC	AD03	WC011A	C30	AD06	V003
	4IT 5+5	40000-49999	TR48U	A		WC011A	AC		WC011A	C30		V003
	4IT 8+8	0001-5000 00001-05000	TR50P	A		WC011A	AC		WC011A	C30		V003
VOLKSWAGEN	2ITL 8	(.....)12345	HU163SU	C		CL005	AC		CL005	A03		V012
		HAA0001-6000 HAA0001-8110 NAA0001-8110	V66U	C		WC011A	AC		WC011A	A03		V003
	2ITL 9+3+3	(.....)12345	HU162U	V		CL005	V		CL005			
VOLVO	2ETR 8	A001-F099	ORIGINAL	A		WC011A	AC		WC011A	C30		V003
		DH0001-DH4000 DH6001-DH8000	VL15P	B		WC011A	B		WC011A	A02		V003
		DN6001-DN8000	VL16P	B		WC011A	B		WC011A	A02		V003
	2ETR 10	04001-09001 4001-9001	VL22P	A		WC011A	AC		WC011A	C30		V003
	4ET 4+4	0AAAA-9XXXX 1V00001-5V12295 AOSAYK-YKGYGC	VL17P	A		WC011A	AC		WC011A	C30		V003

994 LASER | NINJA LASER | NINJA TOTAL MOTORCYCLE KEYS

MAKE	KEY SYSTEM	SERIES	KL REFERENCE	994 LASER			NINJA LASER			NINJA TOTAL		
				Jaw	Adaptor	Cutter	Jaw	Adaptor	Cutter	Jaw	Adaptor	Cutter
APRILIA	4IT 5+4	Z2001-Z9416	ZAD30U	A	AV08	WC011A	AC	AV08	WC011A	C30	AV08	V016
BAJAJ	2ETR 8	00001-03001	FD40U	A		WC011A	AC		WC011A	C30		V003
DUCATI	4IT 5+4	Z2001-Z9416	ZAD30U	A	AV08	WC011A	AC	AV08	WC011A	C30	AV08	V016
GILERA	2ITL 8	DE1-DE11210	FT22U	C		WC011A	AC		WC011A	A03		V003
KTM	2ETR 8	00001-03001	FD40U	A		WC011A	AC		WC011A	C30		V003
MOTO GUZZI	4IT 5+4	Z2001-Z9416	ZAD30U	A	AV08	WC011A	AC	AV08	WC011A	C30	AV08	V016

QUICK GUIDE TO LASER KEY SYSTEMS

NINJA VORTEX | VERSA CAR KEYS

MAKE	KEY SYSTEM	SERIES	KL REFERENCE	NINJA VORTEX			VERSA		
				Jaw	Adaptor	Cutter	Jaw	Adaptor	Cutter
ABARTH	2ITL 8	(.....) ABCD DE00001-DE11210	FT22U	A03		V003	A03		V003
ACURA	4ET 6+6	H001-N718 K001-N718	HD1U	A01		V003	A01		V003
	4IT 5+5	12345	ORIGINAL	A02		V003	A02		V003
ALFA ROMEO	2ITL 8	(.....) ABCD DE00001-DE11210	FT22U	A03		V003	A03		V003
ASTON MARTIN	2ETR 10	01-3022 H1-H3000 WH1-WH3000	VX4P	A01		V003	A01		V003
AUDI	2ITL 8	1-6000 EXT 6001-8100 EXT HAA0001-8110 EXT HAA6001-8110 NAA0001-8110 EXT NAA6001-8110	AD66U	A03		V003	A03		V003
		6001-8100 1ATS1-1ATS17850 0001-6000 HAA0001-2000 HAA0001-6000 HAA0001-8110 NAA0001-2000 NAA0001-8110	AD66U	A03		V003	A03		V003
BMW	2ITL 8	HF000001-HF004001 Z0001-Z1000	ORIGINAL	A03		V003	A03		V003
	2ITR 8	0001-8100	BM2U	A03		V003	A03		V003
	4ET 6+6	BH010001-BH241450	HU58P	A02		V003	A02		V003
BUICK	2ITR 8	Z0001-Z2000 Z0001-Z6000 Z0001-Z6314 Z2001-Z4000	VX5U	A03		V003	A03		V003
CADILLAC	2ITR 8	Z0001-Z2000 Z0001-Z6000 Z2001-Z4000 Z4001-Z6314	VX5U	A03		V003	A03		V003
	2ITR 10	V0001-V6000	VX5U	A03		V003	A03		V003
CHEVROLET	2ITR 8	0001-3679 Z0001-Z6000	ORIGINAL	A03		V003	A03		V003
		Z0001-Z2000 Z2001-Z4000 Z4001-Z6314	VX5U	A03		V003	A03		V003
	2ITR 10	V0001-V5718	ORIGINAL	A03		V003	A03		V003
		V0001-V6000	VX5U	A03		V003	A03		V003
CHRYSLER	2ETL 10 ROUND	1002001-1003200	MB41P	A04		V003	A04		V003
	2ETL FLAT 10	0001-0355 3501-6700 1003501-1006700	MB57P	A04		V003	A04		V003
CITROËN	2ITR 7 LARGE	1-2000 HCA0001-HCA2000 HOOHCA1-HOOHCA2000	PG83U	A03		V003	A03		V003
DODGE	2ETL FLAT 10	3501-6700	MB57P	A04		V003	A04		V003
EUNOS	4IT 8+8	20001-21200	ORIGINAL	A01		V003	A01		V003
FIAT	2ITL 8	(.....) ABCD DE00001-DE11210	FT22U	A03		V003	A03		V003
	2ITR 7 LARGE	1-2000 HCA0001-HCA2000	PG83U	A03		V003	A03		V003
FORD (AUSTRALIA)	2ETR 10	0001-4000	FD40U	A01		V003	A01		V003
FORD (EUROPE)	2ETR 10	0001-4000	FD40U	A01		V003	A01		V003

QUICK GUIDE TO LASER KEY SYSTEMS

NINJA VORTEX | VERSA CAR KEYS

MAKE	KEY SYSTEM	SERIES	KL REFERENCE	NINJA VORTEX			VERSA		
				Jaw	Adaptor	Cutter	Jaw	Adaptor	Cutter
FORD (EUROPE)	2ITL 8	DE00001-DE11210	FT22U	A03		V003	A03		V003
		HAA0001-8110	AD66U	A03		V003	A03		V003
FORD (USA)	2ETR 7	11501-13000	FD40U	A01		V003	A01		V003
	2ETR 10	0001-4000 10001-11500 10001-14514 14515-15014	FD40U	A01		V003	A01		V003
GENESIS	4IT 4+3	X0001-X2245	TR49U	A01		V003	A01		V003
	4IT 4+3 SLIM	I0001-I2608	ORIGINAL	A01	AD06	V003	A01	AD06	V003
GMC	2ITR 8	Z0001-Z6000	VX5U	A03		V003	A03		V003
	2ITR 10	V0001-V5718 V0001-V6000	VX5U	A03		V003	A03		V003
HOLDEN	2ETR 10	H1-H3000 M1-M3000 WH1-WH3000	VX4U	A01		V003	A01		V003
	2ETR 10	WY1-WY3000 Y1-Y3000	VX3U	A01		V003	A01		V003
	2ITR 8	Z0001-Z6314	VX5U	A03		V003	A03		V003
HONDA	4ET 6+6	0H001-0N718 0K001-0N718 (A/Z)H001-N718 (A/Z)K001-N718 H001-N718 K001-N718	HD1U	A01		V003	A01		V003
	4IT 5+5	12345	ORIGINAL	A02		V003	A02		V003
HYUNDAI	2ITL 8	1001-3500 T1001-T3500 X1001-3500	HY21U	A01		V003	A01		V003
		5001-6616	HY20U	A03		V003	A03		V003
		B0001-B3000	ORIGINAL	A01		V003	A01		V003
	2ITR 8	C1001-C3500	ORIGINAL	A03		V003	A03		V003
	4IT 6+6	G0001-G2500 HK1-HK2500 J0001-J2500 K0001-K2500 T1-T2500	TR49U	A01		V003	A01		V003
4IT SLIM 4+3	B0001-B2608 I0001-I2608 X0001-X2245	ORIGINAL	A01	AD06	V003	A01	AD06	V003	
INFINITI	4ET 5+5	0001-2000 2001-6000	ORIGINAL	A01	AV01	V003	A01	AV01	V003
JEEP	2ITL 8	DE00001-DE11210	FT22U	A03		V003	A03		V003
KIA	2ETL 7	0001-2300	ORIGINAL	A01		V003	A01		V003
	2ITL 8	B0001-B3000 D0001-D3000	ORIGINAL	A01		V003	A01		V003
		C0001-C2900 KC001-KC2500 TB1001-3500	ORIGINAL	A01		V003	A01		V003
	2ITR 8	UM1001-UM3500	ORIGINAL	A03		V003	A03		V003
	4IT 4+3	KU0001-KU2608 U0001-U2500	TR49U	A01		V003	A01		V003
	4IT 6+6	E1-E2500 G0001-G2500 K0001-K2500 KE0001-KE2500 KG1-KG2500 T1-T2500 V0001-V2500	TR49U	A01		V003	A01		V003
4IT 8+8	L0001-L1037	KI4	A01		V003	A01		V003	
	L1-L1037	TR49U	A01		V003	A01		V003	

QUICK GUIDE TO LASER KEY SYSTEMS

NINJA VORTEX | VERSA CAR KEYS

MAKE	KEY SYSTEM	SERIES	KL REFERENCE	NINJA VORTEX			VERSA		
				Jaw	Adaptor	Cutter	Jaw	Adaptor	Cutter
KIA	4IT SLIM 4+3	I0001-I2608	ORIGINAL	A01	AD06	V003	A01	AD06	V003
LANCIA	2ITL 8	(.....) ABCD DE00001-DE11210	FT22U	A03		V003	A03		V003
LAND ROVER	2ETR 10	0001-4000	FD40U	A01		V003	A01		V003
	2ITR 8	00001-81000	BM22P	A03		V003	A03		V003
	4ET 5+5	1-6000	ORIGINAL	A02		V003	A02		V003
LEXUS	4IT 4+4	80000-89999	ORIGINAL	A01	AD06	V003	A01	AD06	V003
	4IT 5+5	40000-49999	TR48U	A01		V003	A01		V003
	4IT 8+8	0001-5000 00001-05000	TR50P	A01		V003	A01		V003
LINCOLN	2ETR 10	10001-11500	FD40U	A01		V003	A01		V003
MAHINDRA	2ETR 10	12345 00001-03001	FD40U	A01		V003	A01		V003
	2ITL 8	5001-6616	ORIGINAL	A03		V003	A03		V003
MAZDA	4IT 8+8	20001-21200	ORIGINAL	A01		V003	A01		V003
MERCEDES	2ET SHORT 10	(.....)12345	MB54P	A04		V003	-		-
	2ET-R ROUND 10	HA2001-HA3200 HA2501-HA3500 NA2001-NA3200 NA2501-NA3500	MB54P	A04		V003	A04		V003
	2ETL FLAT 10	0001-0355 3501-6700 1003501-1006700 210103210101-...200	MB57P	A04		V003	A04		V003
	2ETL LONG 13	HA10001-HA30057 NA10001-NA30057	MB58P	A04		V003	A04		V003
	4ET 8+8	2002001-2003500 700001-703000 HS2001-HS3500 NS2001-NS3500	MB53P	A01		V003	A01		V003
MITSUBISHI	2ETR 8	00001-04000 DH0001-DH4000 DH6001-DH8000	VL15P	A02		V003	A02		V003
	4IT 8+8	30001-31200	TR49U	A01		V003	A01		V003
NISSAN	4ET 5+5	0001-2000 2001-6000	ORIGINAL	A01	AV01	V003	A01	AV01	V003
OPEL	2ETR 10	1-3022 HI-H3000 M1-M3000 WY1-WY3000 Y1-Y3000	VX3U	A01		V003	A01		V003
	2ITR 8	1-3679 Z0001-Z2000 Z0001-Z6314 Z2001-Z4000 Z4001-Z6314	VX5U	A03		V003	A03		V003
PEUGEOT	2ITL 6	ABCDEF	PG33U	A03		V003	A03		V003
	2ITL 8	(.....) ABCD DE00001-DE11210	FT22U	A03		V003	A03		V003
	2ITR 7 LARGE	1-2000 HCA0001-HCA2000 HOOHCA1-HOOHCA2000	PG83U	A03		V003	A03		V003
	4ET 5+5	0123456789ABCDEF	PG31U	A02		V003	A02		V003
	4IT-T THIN 6	ABCDEF (0/Z 0/Z 0/Z 0/Z...) ABCDEF	PG33U	A03		V003	A03		V003
PORSCHE	2ITL 8	01-06000 1-6000 1-6000 EXT 6001-8100 6001-8100 EXT HAA0001-8110	AD66U	A03		V003	A03		V003

QUICK GUIDE TO LASER KEY SYSTEMS

NINJA VORTEX | VERSA CAR KEYS

MAKE	KEY SYSTEM	SERIES	KL REFERENCE	NINJA VORTEX			VERSA		
				Jaw	Adaptor	Cutter	Jaw	Adaptor	Cutter
RAM	2ITL 8	DE00001-DE11210	FT22U	A03		V003	A03		V003
RANGE ROVER	2ETR 10	0001-4000	FD40AP	A01		V003	A01		V003
	4ET 5+5	1-6000	ORIGINAL	A02		V003	A02		V003
RENAULT	2ITL 7	000001-992196	HY21U	A01		V003	A01		V003
	2ITR 6	UC0001-UC1200	PG33U	A03		V003	A03		V003
SAAB	2ETR 10	2S1-2S2675 BC1-BC2865	ORIGINAL	A03		V003	A03		V003
	2ITL 7	DA1-DA2892	ORIGINAL	A03		V003	A03		V003
	2ITL 8	DB1-DB4500	ORIGINAL	A03		V003	A03		V003
	2ITR 8	Z0001-Z6314	VX5U	A03		V003	A03		V003
SATURN	2ITR 8	Z0001-Z6000	VX5U	A03		V003	A03		V003
SEAT	2ITL 8	HAA0001-8110	AD66U	A03		V003	A03		V003
SMART	2ETR 8	DH0001-DH4000 DH6001-DH8000	ORIGINAL	A02		V003	A02		V003
	2ITL 6	1234Q5678H	PG33U	A03		V003	A03		V003
SSANGYONG	4IT 6+6	KW1-KW2500	TR50P	A01		V003	A01		V003
SUBARU	4ET 5+5	T0001-T3000	SUB1U	A01		V003	A01		V003
TOYOTA	2ETR 10	H1-H3000 M1-M3000 WH1-WH3000	VX4P	A03		V003	A03		V003
	2ITL 6	12897-A9999 B1085-B9547	PG33U	A03		V003	A03		V003
	2ITL 8	025A1-WV6AG	ORIGINAL	A01		V003	A01		V003
	4IT 4+4	80000-89999	ORIGINAL	A01	AD06	V003	A01	AD06	V003
	4IT 5+5	40000-49999	TR48U	A01		V003	A01		V003
	4IT 8+8	0001-5000 00001-05000	TR50P	A01		V003	A01		V003
VOLKSWAGEN	2ITL 8	(.....)12345	HU163SU	A03		V012	A03		V012
		HAA0001-6000 HAA0001-8110 NAA0001-8110	V66U	A03		V003	A03		V003
	2ITL 9+3+3	(.....)12345	HU162U						
VOLVO	2ETR 8	A001-F099	ORIGINAL	A01		V003	A01		V003
		DH0001-DH4000 DH6001-DH8000	VL15P	A02		V003	A02		V003
		DN6001-DN8000	VL16P	A02		V003	A02		V003
	2ETR 10	04001-09001 4001-9001	VL22P	A01		V003	A01		V003
	4ET 4+4	0AAAA-9XXXX 1V00001-5V12295 AOSAYK-YKGYGC	VL17P	A01		V003	A01		V003

NINJA VORTEX | VERSA MOTORCYCLE KEYS

MAKE	KEY SYSTEM	SERIES	KL REFERENCE	NINJA VORTEX			VERSA		
				Jaw	Adaptor	Cutter	Jaw	Adaptor	Cutter
APRILIA	4IT 5+4	Z2001-Z9416	ZAD30U	A01	AV08	V016	A01	AV08	V016
BAJAJ	2ETR 8	00001-03001	FD40U	A01		V003	A01		V003
DUCATI	4IT 5+4	Z2001-Z9416	ZAD30U	A01	AV08	V016	A01	AV08	V016
GILERA	2ITL 8	DE1-DE11210	FT22U	A03		V003	A03		V003
KTM	2ETR 8	00001-03001	FD40U	A01		V003	A01		V003
MOTO GUZZI	4IT 5+4	Z2001-Z9416	ZAD30U	A01	AV08	V016	A01	AV08	V016

QUICK GUIDE TO LASER KEY SYSTEMS

303 / 304 / 305 / PUNTO | T-REX / T-REX ADVANCE
CAR KEYS

MAKE	KEY SYSTEM	KL REFERENCE	303 / 304 / 305 / PUNTO		T-REX / T-REX ADVANCE	
			Adaptor	Cutter	Adaptor	Cutter
ABARTH	2ITL 8	FT22U		HC011		HC011
ACURA	4ET 6+6	HD1U		HC011		HC011
	4IT 5+5	ORIGINAL		HC011		HC011
ALFA ROMEO	2ITL 8	FT22U		HC011		HC011
ASTON MARTIN	2ETR 10	VX4P	MOMAX	HC011	MOMAX	HC011
AUDI	2ITL 8	AD66U	MA	HC011 or HC030		HC011 or HC030
BMW	2ITL 8	ORIGINAL		HC011		HC011
	2ITR 8	BM2U		HC030		HC030
	4ET 6+6	HU58P		HC011		HC011
BUICK	2ITR 8	VX5U		HC011		HC011
CADILLAC	2ITR 8	VX5U		HC011		HC011
	2ITR 10	VX5U		HC011		HC011
CHEVROLET	2ITR 8	ORIGINAL		HC011		HC011
		VX5U		HC011		HC011
	2ITR 10	VX5U		HC011		HC011
		ORIGINAL		HC011		HC011
CHRYSLER	2ETL 10 ROUND	MB41P		HC011		HC011
	2ETL FLAT 10	MB57P	MM	HC011	MM	HC011
CITROËN	2ITR 7 LARGE	PG83U		HC030		HC030
DODGE	2ETL FLAT 10	MB57P	MM	HC011	MM	HC011
EUNOS	4IT 8+8	ORIGINAL		HC011		HC011
FIAT	2ITL 8	FT22U		HC044		HC044
	2ITR 7 LARGE	PG83U		HC030		HC030
FORD (AUSTRALIA)	2ETR 10	FD40U	MOMAX	HC011 or HC030	MOMAX	HC011 or HC030
FORD (EUROPE)	2ETR 10	FD40U	MOMAX	HC011 or HC030	MOMAX	HC011 or HC030
	2ITL 8	AD66U	MA	HC011 or HC030		HC011 or HC030
		FT22U		HC044		HC044
FORD (USA)	2ETR 7	FD40U	MOMAX	HC011 or HC030	MOMAX	HC011 or HC030
	2ETR 10	FD40U	MOMAX	HC011 or HC030	MOMAX	HC011 or HC030
GENESIS	4IT 4+3	TR49U		HC011		HC011
GMC	2ITR 8	VX5U		HC011		HC011
	2ITR 10	VX5U		HC011		HC011
HOLDEN	2ETR 10	VX3U	MOMAX	HC011	MOMAX	HC011
		VX4U	MOMAX	HC011	MOMAX	HC011
	2ITR 8	VX5U		HC011		HC011
HONDA	4ET 6+6	HD1U		HC011		HC011
	4IT 5+5	ORIGINAL		HC011		HC011
HYUNDAI	2ITL 8	HY21U		HC011		HC011
		ORIGINAL		HC011		HC011
		HY20U		HC011		HC011
	2ITR 8	ORIGINAL		HC011		HC011
	4IT 6+6	TR49U		HC011		HC011
JEEP	2ITL 8	FT22U		HC044		HC044
KIA	2ETL 7	ORIGINAL		HC011		HC011
	2ITL 8	ORIGINAL		HC011		HC011
	2ITR 8	ORIGINAL		HC011		HC011
	4IT 4+3	TR49U		HC011		HC011
	4IT 6+6	TR49U		HC011		HC011

QUICK GUIDE TO LASER KEY SYSTEMS

303 / 304 / 305 / PUNTO | T-REX / T-REX ADVANCE
CAR KEYS

MAKE	KEY SYSTEM	KL REFERENCE	303 / 304 / 305 / PUNTO		T-REX / T-REX ADVANCE	
			Adaptor	Cutter	Adaptor	Cutter
KIA	4IT 8+8	KI4		HC011		HC011
		TR49U		HC011		HC011
LANCIA	2ITL 8	FT22U		HC044		HC044
LAND ROVER	2ETR 10	FD40U	MOMAX	HC011 or HC030	MOMAX	HC011 or HC030
	2ITR 8	BM22P		HC011		HC011
	4ET 5+5	ORIGINAL		HC011		HC011
LEXUS	4IT 5+5	TR48U		HC011		HC011
	4IT 8+8	TR50P		HC011		HC011
LINCOLN	2ETR 10	FD40U	MOMAX	HC011 or HC030	MOMAX	HC011 or HC030
MAHINDRA	2ETR 10	FD40U	MOMAX	HC011 or HC030	MOMAX	HC011 or HC030
	2ITL 8	ORIGINAL		HC011		HC011
MAZDA	4IT 8+8	ORIGINAL		HC011		HC011
MERCEDES	2ET-R ROUND 10	MB54P	MM	HC011	MM	HC011
	2ETL FLAT 10	MB57P	MM	HC011	MM	HC011
	2ETL LONG 13	MB58P	MM	HC011	MM	HC011
	4ET 8+8	MB53P		HC011		HC011
MITSUBISHI	2ETR 8	VL15P		HC011		HC011
	4IT 8+8	TR49U		HC011		HC011
OPEL	2ETR 10	VX3U	MOMAX	HC011	MOMAX	HC011
	2ITR 8	VX5U		HC011		HC011
PEUGEOT	2ITL 6	PG33U		HC011		HC011
	2ITL 8	FT22U		HC044		HC044
	2ITR 7 LARGE	PG83U		HC030		HC030
	4ET 5+5	PG31U		HC011		HC011
	4IT-T THIN 6	PG33U		HC011		HC011
PORSCHE	2ITL 8	AD66U	MA	HC011 or HC030		HC011 or HC030
RAM	2ITL 8	FT22U		HC044		HC044
RANGE ROVER	2ETR 10	FD40AP	MOMAX	HC011 or HC030	MOMAX	HC011 or HC030
	4ET 5+5	ORIGINAL		HC011		HC011
RENAULT	2ITL 7	HY21U		HC011		HC011
	2ITR 6	PG33U		HC011		HC011
SAAB	2ETR 10	ORIGINAL		HC011		HC011
	2ITL 7	ORIGINAL		HC011		HC011
	2ITL 8	ORIGINAL		HC011		HC011
	2ITR 8	VX5U		HC011		HC011
SATURN	2ITR 8	VX5U		HC011		HC011
SEAT	2ITL 8	AD66U	MA	HC011 or HC030		HC011 or HC030
SMART	2ETR 8	ORIGINAL		HC011		HC011
	2ITL 6	PG33U		HC011		HC011
SSANGYONG	4IT 6+6	TR50P		HC011		HC011
SUBARU	4ET 5+5	SUB1U		HC011		HC011
TOYOTA	2ETR 10	VX4P		HC011		HC011
	2ITL 6	PG33U		HC011		HC011
	2ITL 8	ORIGINAL		HC011		HC011
	4IT 5+5	TR48U		HC011		HC011
	4IT 8+8	TR50P		HC011		HC011
VOLKSWAGEN	2ITL 8	HU163SU		HC023		HC023
		V66U	MA	HC011 or HC030		HC011 or HC030

QUICK GUIDE TO LASER KEY SYSTEMS

303 / 304 / 305 / PUNTO | T-REX / T-REX ADVANCE CAR KEYS

MAKE	KEY SYSTEM	KL REFERENCE	303 / 304 / 305 / PUNTO		T-REX / T-REX ADVANCE	
			Adaptor	Cutter	Adaptor	Cutter
VOLKSWAGEN	2ITL 9+3+3	HU162U		HC023		HC023
VOLVO	2ETR 8	VL15P		HC011		HC011
		VL16P		HC011		HC011
		ORIGINAL		HC011		HC011
	2ETR 10	VL22P		HC011		HC011
	4ET 4+4	VL17P		HC011		HC011

303 / 304 / 305 / PUNTO | T-REX / T-REX ADVANCE MOTORCYCLE KEYS

MAKE	KEY SYSTEM	KL REFERENCE	303 / 304 / 305 / PUNTO		T-REX / T-REX ADVANCE	
			Adaptor	Cutter	Adaptor	Cutter
APRILIA	4IT 5+4	ZAD30U		HC011		HC011
BAJAJ	2ETR 8	FD40U	MOMAX	HC011 or HC030	MOMAX	HC011 or HC030
DUCATI	4IT 5+4	ZAD30U		HC011		HC011
GILERA	2ITL 8	FT22U		HC044		HC044
KTM	2ETR 8	FD40U	MOMAX	HC011 or HC030	MOMAX	HC011 or HC030
MOTO GUZZI	4IT 5+4	ZAD30U		HC011		HC011

FRESE

CUTTERS

FRÄSER

FRAISES

FRESAS



CUTTERS

SIGMA PRO / 993 POWER LYNX | 200 SERIES | FALCON | FOCUS

MOD.	REF.	D	F	S	P	No.	MAT.	TYPE	KCM
HS020	RIC01860B	63	16	1,4	1,4	80	HSS	L	201
HSSG1	RIC01858B	80	22	1,5	1,5	100	HSS	-	202 203 204
HSSG10	RIC01868B	80	22	2	2	100	HSS	-	202 203 204
HSSG12	RIC09113B	80	22	2,5	2,5	100	HSS	-	202 203 204 Falcon
HSSG2	RIC01872B	80	22	1,5	1,5	100	HSS	L	202 203 204
HSSG3	RIC01857B	80	22	1	1	100	HSS	-	202 203 204
HSSG30	RIC01866B	80	22	1,2	1,2	100	HSS	-	202 203 204
HSSG31	RIC01870B	80	22	2,4	2,4	100	HSS	-	202 203 204
HSSG32	RIC01733B	63	16	1,5	1,5	80	HSS	-	201
HSSG33	RIC01859B	63	16	2,4	2,4	64	HSS	-	201
HSSG35	RIC02133B	63	16	1,25	1,25	80	HSS	L	201
HSSG37	RIC02961B	76,2	19,05	2,4	2,4	120	HSS	-	Focus
HSSG38	RIC04294B	80	22	1,5	1,5	100	HSS	L	202 203 204
HSSG39	RIC04296B	80	22	1,25	1,25	100	HSS	L	202 203 204
HSSG4	RIC02663B	80	22	1,25	1,25	100	HSS	-	202 203 204
HSSG40	RIC04608B	63	16	1	1	80	HSS	-	201
HSSG41	RIC09893B	80	22	2,5	2,5	100	HSS	L	202 203 204 Falcon
HSSG6	RIC01864B	80	22	1,3	1,3	100	HSS	L	202 203 204 206
WSSG1	RIC01856B	80	22	1,5	1,5	100	W	-	202 203 204
WSSG36	RIC02865B	100	22	1,25	1,25	128	W	-	Sigma Pro / 993 Power Lynx
WSPL1	RIC03904B	100	22	1	1	128	W	-	Sigma Pro / 993 Power Lynx
WSPL1.25	RIC06716B	100	22	1,25	1,25	64	W	-	Sigma Pro / 993 Power Lynx
WSPL1.6	RIC06312B	100	22	1,6	1,6	128	W	-	Sigma Pro / 993 Power Lynx
WSPL1.8	RIC08408B	100	22	1,8	1,8	128	W	-	Sigma Pro / 993 Power Lynx
WSPL1.9	RIC09637B	100	22	1,9	1,9	128	W	-	Sigma Pro / 993 Power Lynx

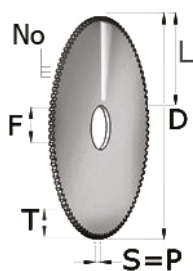

OTHERS

MOD.	REF.	D	F	S	P	T	No.	MAT.	TYPE	KCM
WSSG32	RIC03910B	63	16	1,5	1,5	-	-	W	-	Halley Round*
WSPL1	RIC03904B	100	22	1	1	-	-	W	-	Idea* Prima Laser*
HSCU18	RIC03914B	32	12	1,35	1,35	-	-	HSS	-	Mizar*
HSSG18	RIC03902B	64,6	9,52	2,4	2,4	-	-	HSS	L	Delta AY* Delta FO*

* Key Cutting machines not produced by Keyline available in the market.

* Macchine duplicatrici non prodotte da Keyline presenti sul mercato.

* Machines à reproduire les clés pas produites par Keyline disponibles dans le marché.

* Nicht von Keyline hergestellte Schlüsselfräsmaschinen die auf dem Markt anwesend sind.

* Maquinas duplicadoras no producidas de parte de Keyline disponibles en el mercado.

CUTTERS

DEZMO

MOD.	REF.	D	F	S	V°	I	P	No.	MAT.	KCM
F01	RIC08143B	80	16	5	80	0,15	0,5	80	W	Dezmo
F02	RIC08213B	80	16	5	80	0,15	0,5	50	W	Dezmo

NINJA TOTAL | NINJA LASER | NINJA

MOD.	REF.	D	F	S	V°	I	P	No.	MAT.	KCM
HP034	RIC09167B	63	16	5	70	0,5	0,15	80	HSS	Ninja Total Ninja Laser Ninja
WP034	RIC09168B	63	16	5	70	0,5	0,15	80	W	Ninja Total Ninja Laser Ninja
WP034B	RIC09234B	63	16	5	70	0,5	0,15	40	W	Ninja Total Ninja Laser Ninja

CARAT | 100 SERIES | ECO

MOD.	REF.	D	F	S	V°	I	P	No.	MAT.	KCM
HP005	RIC01721B	63	16	5	84	1,25	0,15	80	HSS	101
HP005S	RIC02102B	63	16	5	80	1,25	0,15	80	HSS	101
HPP01	RIC01720B	80	16	5	84	1,25	0,15	110	HSS	Carat 102 103 104
HPP01S	RIC02098B	80	16	5	80	1	0,15	110	HSS	Carat Easy 102 103 104 Euro Lupo
WP005	RIC01855B	63	16	5	84	1,25	0,15	80	W	101
WPP01	RIC01717B	80	16	5	84	1,25	0,15	100	W	Carat 102 103 104
WPP01S	RIC02106B	80	16	5	80	1	0,15	100	W	Carat 102 103 104
WPP24	RIC01826B	40	10	6	77,3	2,25	0,2	40	HSS	105
HPP032	RIC05808B	80	16	5	80	0,5	0,15	110	HSS	Carat
HPP033	RIC05810B	80	16	11	90	5,5	0,8	110	HSS	Carat
HP029	RIC02741B	75	10	5	80	1	0,15	100	HSS	Eco
HP030	RIC01967B	75	10	5	80	1	0,15	100	HSSC	Eco
HP031	RIC01969B	75	10	5	80	1	0,15	100	HSSPC	Eco

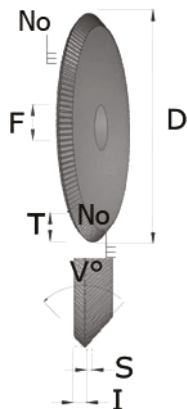

OTHERS

MOD.	REF.	D	F	S	V°	I	P	No.	MAT.	KCM
HPP01U	RIC01971B	80	16	5	80	0,5	-	100	HSS	KD50*
HPP08	RIC03922B	40	8	5	42	-	-	-	HSS	Blitz*
HPP21	RIC04298B	60,4	9,52	5,25	84	0,5	0,15	70	HSS	Delta*
HPU01	RIC03906B	60,4	9,52	5,25	80	0,5	0,1	-	HSS	Unocode*

* Key Cutting machines not produced by Keyline available in the market.

* Macchine duplicatrici non prodotte da Keyline presenti sul mercato.

* Machines à reproduire les clés pas produites par Keyline disponibles dans le marché.

* Nicht von Keyline hergestellte Schluesselfraesmaschinen die auf dem Markt anwesend sind.

* Maquinas duplicadoras no producidas de parte de Keyline disponibles en el mercado.

CUTTERS

NINJA TOTAL | NINJA VORTEX | VERSA

MOD.	REF.	L	C	V	D	P	MAT.
V000	RIC05050B	32	-	60	4	0,1	W
V001	RIC05044B	32	4	90	4	0,4	W
V004	RIC05084B	32	4	82	4	0,5	W
V005	RIC05240B	32	4	80	4	0,4	W
V006	RIC05262B	32	4	96	4	0,4	W
V007	RIC05264B	32	4	100	4	0,4	W
V008	RIC05266B	32	4	106	4	0,6	W
V009	RIC05268B	32	4	108	4	0,6	W
V010	RIC05270B	32	4	110	4	0,3	W
V011	RIC05272B	32	4	120	4	0,3	W
V013	RIC05618B	32	4	90	4	0,7	W
V014	RIC05612B	32	4	90	4	0,6	W
V021	RIC06104B	32	3,2	90	4	0,8	W
V022	RIC06368B	32	2,7	90	4	0,8	W
V025	RIC06370B	32	4	104	4	0,4	W
V026	RIC06372B	32	4	105	4	0	W
V027	RIC06730B	32	4	100	4	0,8	W
V029	RIC06409B	32	-	-	-	-	W
V030	RIC06732B	32	-	-	-	-	W
V033	RIC07247B	32	3,6	90	4	1,6	W
V034	RIC07726B	32	3,2	120	4	0,8	W
V036	RIC07785B	32	4	87	4	0,5	W
V039	RIC08161B	32	6	95	4	1	W
V040	RIC08302B	32	8	96	4	1,20	W
V042	RIC09210B	32	4	30	4	1,60	W
V044	RIC09442B	32	4	90	4	0,20	W
V045	RIC09480B	32	4	105	4	1,20	W
V047	RIC10290B	32	2,6	97	4	0,60	W
V050	RIC10506B	32	4	78	4	1,2	W

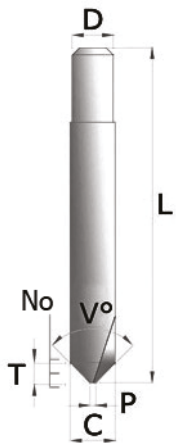

T-REX | T-REX ADVANCE | PUNTO | 300 SERIES

MOD.	REF.	L	C	V	D	P	MAT.
HB001	RIC01791B	45	6	90	6	0,7	HSS
WB001	RIC08487B	45	6	90	6	0,7	W
HB005	RIC01775B	45	6	90	6	0,9	HSS
HB007	RIC01787B	45	6	72	6	0,8	HSS
HB012A	RIC01777B	45	-	100	6	0,6	HSS
HB012B	RIC01779B	45	8	96	8	2,8	HSS
HB015	RIC01781B	45	8	90	6	0,8	HSS
WB019	RIC08488B	45	-	90	6	0,56	W
HB020	RIC01793B	45	6	90	6	0,45	HSS
HB026	RIC01783B	45	6	82	6	0,8	HSS
HB037	RIC03964B	48	6	80	6	0,7	HSS
HB038	RIC03970B	48	6	80	6	0,8	HSS
HB039	RIC01785B	45	6	90	6	0,6	HSS
HB042	RIC01789B	45	6	100	6	0,7	HSS
HB043	RIC01822B	45	6	90	6	1	HSS
HB045A	RIC09770B	45	3,2	105	6	1,2	HSS
HB045B	RIC09771B	45	6	105	6	1,2	HSS

CUTTERS

NINJA TOTAL | NINJA VORTEX | VERSA

MOD.	REF.	T	L	D	P/C	MAT.
V002	RIC05046B	3,5	32	4	3	W
V003	RIC05048B	3,5	32	4	2,5	W
V012	RIC05274B	3,5	32	4	1,5	W
V015	RIC05614B	1,5	32	4	3,08	W
V016	RIC05616B	0,75	32	4	2,3	W
V017	RIC05508B	2,5/7	32	4	3	W
V018	RIC05506B	1,5	32	4	2,7	W
V020	RIC06102B	1	32	4	1,28	W
V023	RIC06508B	0,8	32	4	2,26	W
V024	RIC06116B	3	32	6	3	W
V031	RIC06734B	1	32	4	1,85	W
V035	RIC07782B	1	32	4	1,08	W
V037	RIC07786B	4	32	4	2	W
V038	RIC08166B	1	32	4	2,5	W
V041	RIC08315B	1	32	4	2	W
V043	RIC09211B	2	32	4	1,6	W
V046	RIC09666B	1,1	40	4	2,7	W

NINJA LASER | 994 LASER

MOD.	REF.	T	L	D	P/C	MAT.
WC011A	RIC05304B	3,5	40	6	2,5	W
CL004	RIC08409B	6	43	6	1,5	W
CL005	RIC09617B	4	40	6	1,5	W

T-REX | T-REX ADVANCE | PUNTO | 300 SERIES

MOD.	REF.	T	L	D	P/C	MAT.
HC003	RIC01820B	0,9	45	6	1,5	HSS
HC008	RIC03978B	12	48	6	4	HSS
HC011	RIC01810B	5	45	6	2,5	HSS
WC011	RIC08490B	5	45	6	2,5	W
HC023	RIC01812B	5	45	6	1,5	HSS
HC030	RIC01715B	6	45	6	3	HSS
HC044	RIC01816B	6	45	6	2	HSS
HC130	RIC08491B	3	45	6	1,3	HSS
HC131	RIC01818B	13	45	6	6	HSS
HC208	RIC01808B	5	42	6	2,4	HSS

ARCADIA

MOD.	REF.	T	L	D	P/C	MAT.
	RIC08866B	12	36	6	5,95	HSS



INDICE PER UTILIZZO

APPLICATION INDEX

VERWENDUNGSINDEX

INDEX DE UTILISATION

ÍNDICE DE APLICACIÓN



BIANCHI 1770 GROUP

Innovators by design | Since 1770



INDEX

REF.	PAG.	REF.	PAG.
A		FIAT (I)	172-173-174 175
ABLOY (S)	2-3-4	FICHET (F)	68
ABUS (D)	5-6-7-8-9-10-11	FORD (EU)	176-177-178 182-183
AGA (E)	12	FORD (EU) - FORD (USA)	179-180-181 184-185
AGB (I)	13-14	FTH (F)	69-258
ASSA (S)	15-16	G	
ASSA(S)	17-18	GE-GE (A)	70
ATRA (I)	19-20	GERA (D)	70
AUDI (D)	162-163	GIUSSANI (I)	71
AXA (NL)	21	GOAL (J)	71-72
AZBE (E)	22-23	H	
B		HOLDEN (AUS)	186-187
BASI (D)	23-24	HONDA (J)	188-189-190 191
BILMA (E)	255	HYUNDAI (J)	192
BKS (D)	25	I	
BMW (D)	164-165-166 167-168-169	ICSA (I)	72-73
BRICARD (F)	26-27	IFAM (E)	73-74
BRIDGESTONE (J)	27	INAHO (J)	74
BURG (D)	28	INFINITI (J)	193-194
C		ISEO (I)	75-76-77
CAVITH (F)	255	ITO (TR)	77-78
CES (D)	29-30	J	
CHIAVI A CROCE - CRUCIFORM KEYS	256	JAGUAR (GB)	195
CHIAVI A POMPA - PUMP KEYS	253	JIS (E)	78
CHIAVI A Y - Y KEYS	263	JPM (F)	258
CHIAVI FEMMINA - PIPE KEYS	252	K	
CHIAVI FERMO CENTRALE - MORTICE KEYS	250	KABA (CH)	79-80-81-82 83-84-85-86
CHIAVI FERMO POSTERIORE - BACK STOP BIT KEYS	248	KAKEN (J)	86-87
CHIAVI MAPPA - GERMANY KEYS	250	KALE (TR)	87-88
CHIAVI PER CASELLARI POSTALI (USA) - MAIL BOX KEYS (USA)	257	KESO (CH)	88-89-90
CHIAVI TUBOLARI - TUBULAR KEYS	261-262	KROMER (D)	249
CHUBB (GB)	30-31	KYR (I)	91
CISA (I)	31-32-33-34 35-36-37	L	
CITROEN (F)	170-171	LANCIA (I)	196-197
CITY (F)	37	LAPERCHE (F)	259
CODEM (F)	38	LEHMANN (D)	92
CORBIN (I)	38-39-40	LEXUS (J)	198-199-200
CORNI (I)	40	LINCE (E)	93
CVL (E)	41	LIPS (NL)	94-95-96
D		LUMA (E)	97
DAD-DECAYEUX (F)	257	M	
DE JONG	42	M&C (RO)	97-98
DEFEND LOCK (CZ)	42-43	MAGNUM (NL)	98-99
DELCA (GR)	43	MAUER (BG)	99-100
DIERRE (I)	44	MAZDA (J)	201-202
DOM (D)	44-45-46-48 49-50-51-52	MCM (E)	100-101
DOMUS (GR)	52-53	MEDECO (US)	102
E		MERCEDES (D)	203-204-205 206-207
ELZETT (H)	53	MERONI (I)	102-103
ESETY (I)	54	MG MONTI (I)	103-104-105
EURO-LOCKS (B)	55	MITSUBISHI (J)	208-209
EVVA (A)	56-57-58-59	MIWA (J)	106
EZCURRA (E)	60-61	MORI G. (I)	107
F		MOTTURA (I)	108-109
FAB (CZ)	62-63-64	MUL.T.LOCK (IL)	110-111
FAC (E)	64-65		
FAYN (TR)	65-66		
FCV (D)	66-67		
FIAM (I)	67-68-249		

INDEX

REF.	PAG.	REF.	PAG.
N		WILKA (D)	150-151-152
NIKABA (J)	112	WINKHAUS (D)	152-153-154
NISSAN (J)	210		155
O		Y	
OMECA (I)	113-114	YALE (GB)	156
OPEL (D)	215-216	YARDENI (IL)	157-158
OPEL (D) - VAUXHALL (GB)	211-212-213	Z	
	214	ZADI (I)	159-245-246
P		ZEISS IKON (D)	160
PATENT	251		
PEUGEOT (F)	217-218-219		
	220-221-222		
	223-224		
PFAFFENHAIN (D)	115-116-117		
	118-119-120		
PICARDIE (F)	121		
POLLUX (F)	259-260		
POTENT (I)	121-122		
PREFER (I)	123-124		
PROGRES FONTAINE (F) - CORNI (I)	260-261		
R			
RENAULT (F)	225-226		
S			
SAAB (S)	226-227		
SANS SOUCI (F)	253		
SEA (CH)	125		
SEAT (E)	228-229		
SECUREMME (I)	126-127-128		
	129		
SECURITAL (I)	130		
SECURYSTAR (F)	129		
ŠKODA (CZ)	230-231		
SPIDER (IL)	131		
STS (E)	132-133		
STV (I)	134		
SUBARU (J)	232		
T			
TARONI (I)	135		
TESA (E)	136-137-138		
TESIO (I)	139		
TITAN (SLO)	140-141		
TOPEX (US)	141		
TOVER (E)	142-143-248		
TOYOTA (J)	233-234-235		
U			
UCEM (GB)	143-144		
UNION (GB)	144-145		
V			
VACHETTE (F)	146-147		
VIGIE PICARD (F)	263		
VIRO (I)	147-148-149		
VOLKSWAGEN (D)	236-237-238		
	239-240		
VOLVO (S)	241-242-243		
	244		
W			
WEST (J)	149-150		

Copyright by



Innovators by design | Since 1770

A BIANCHI 1770 GROUP COMPANY

Le illustrazioni e i dati tecnici dei prodotti contenuti nel catalogo debbono considerarsi indicativi.

Keyline si riserva di poter modificare i prodotti illustrati senza compromettere la loro funzionalità ed intercambiabilità al fine di migliorare la qualità del prodotto.

Tutti i disegni e le fotografie sono di proprietà di Keyline, ogni riproduzione anche parziale, senza autorizzazione scritta della Keyline è vietata secondo termini di legge.

Per qualsiasi controversia sono competenti gli Uffici Giudiziari dove ha sede l'Azienda, con espressa esclusione di qualsiasi altro foro.

All information and illustrations in this catalogue are for guidance only.

Keyline reserves the right to alter the illustrated products without compromising their functionality and interchangeability in order to improve the quality of the product itself.

The contents of this catalogue are fully protected by copyright and may not be copied or reproduced in any form without written permission from Keyline.

Any infringements will be dealt with under Italian law.

Die Abbildungen und technischen Daten des Katalogs sind nur zur Information.

Keyline behält sich vor, etwaige Änderungen am Produkt vorzunehmen ohne der Zweckmaessigkeit und Auswechselbarkeit zu gefaehrden um zur Verbesserung des Produkt.

Alle Zeichnungen und Fotos sind Besitz der Firma Keyline, jede Reproduktion, auch teilweise, ist ohne schriftliche Erlaubnis der Firma Keyline gesetzlich untersagt.

Im Falle von Streitfragen ist der Gerichtshof des Firmensitzes zuständig; jeder andere Gerichtshof ist ausgeschlossen.

Les illustrations et les caractéristiques techniques des produits présentés dans ce catalogue sont données à titre indicatif.

Keyline se réserve le droit d'apporter toutes les modifications des produits illustrés sans compromettre leur caractère fonctionnel et interchangeabilité pour améliorer la qualité du produit.

Tous les dessins et photos sont propriété Keyline et toute reproduction, même partielle, sans l'autorisation écrite préalable de Keyline est interdite conformément aux prescriptions légales.

Tout litige est du ressort exclusif des Tribunaux de la circonscription où se trouve le Siège de la Société.

Las ilustraciones y los datos técnicos de los productos en este catálogo son indicativos.

Keyline se reserva el derecho de modificar los productos ilustrados sin comprometer la funcionalidad e intercambiabilidad para mejorar la calidad del producto.

Todos los dibujos y las fotografías pertenecen a la Keyline; se prohíbe toda reproducción aunque parcial, sin autorización por escrito de la Keyline.

En caso de disputas la competencia es de las autoridades judiciales donde está domiciliada la firma, excluyendo cualquier otro foro.

To find the distributor closest to your company,
please send a request to:



Keyline

Keyline S.p.A.
Via Camillo Bianchi, 2 - P.O. Box 251
31015 Conegliano (TV) Italy
T +39 0438 202 511
F +39 0438 202 520
info@keyline.it
www.keyline.it



Bianchi 1770 Group Companies distributing Keyline products

Keyline USA

Bianchi USA, Inc.
31336 Industrial Pkwy - Suite 3
North Olmsted, Ohio 44070, USA
T +1 440 716 8006
F +1 216 803 0202
TF +1 800 891 2118
info@keyline-usa.com
www.keyline-usa.com

Keyline Italia

Keyline Italia S.r.l.
Via Zoe Fontana, 220 - Ed. C
Tecnocittà
00131 Roma, Italy
T +39 06 4122 9822
F +39 06 4120 0981
info@keyline-italia.it
www.keyline-italia.it

Keyline Shanghai

Bianchi 1770 Hardware Technology (Shanghai) Co. Ltd
比安奇五金技术（上海）有限公司
中国上海市虹口区黄浦路99号
上海滩国际大厦1505室
Room 1505, Shanghai Bund International Tower
No.99 Huangpu Road, Hong Kou District 200080
Shanghai P.R. China
T +86 021 5031 0980
F +86 021 5031 0981
info@keyline-shanghai.com
www.keyline-shanghai.com

Keyline Germany

Keyline GmbH
Uhlandstraße 31b
42549 Velbert, Germany
T +49 (0) 2051 807 4444
F +49 (0) 2051 606 9922
info@keyline-germany.de
www.keyline-germany.de

Bianchi 1770 Group Representative Offices coordinating onsite distributors

Keyline UK

18 Beeston Court - Stuart Road
Manor Park - Runcorn - Cheshire
WA7 1SS - UK
T +44 (0) 1928 571 167
F +44 (0) 1928 579 595
info@keyline-uk.co.uk
www.keyline-uk.co.uk

Keyline Japan

〒532-0011
大阪府大阪市淀川区西中島4-7-20
日宝新大阪第1ビル4階1号
Room 4F-1 Nippo Shin-Osaka Daiich Building
4-7-20 Nishinakajima, Yodogawa-ku Osaka City
Osaka 532-0011, Japan
T +81 6 4805 6969
F +81 6 4805 6900
info@keyline-japan.jp
www.keyline-japan.jp



ISO TS 16949 CERTIFIED COMPANY -
IATF CERTIFICATE N.0248044

